

Productmap

Click on a product for more information.

Rectangular

- PP.BL Concrete Ping-pong table blue
- PP.GR Concrete Ping-pong table green
- PP.A Concrete Ping-pong table anthracite
- PP.NT Ping-pong table in natural concrete
- PP.AB Ping-pong table Anthracite-Concrete

Rectangular Standard

- PS.ST Picnic table Standard Natural Concrete
- PS.ST.AB Picnic table Standard Anthracite-Concrete
- PS.ST.A Concrete Picnic table Standard Anthracite

Schaakbanken

- BB.CH Chess Bench, Natural Concrete
- BB.CH.AB Chess Bench, Anthracite-Concrete

Schaaktafel 4 personen

- GT.CH.4 Chess Table Natural Concrete (4P)
- GT.CH.AB4 Chess Table Anthracite-Concrete (4P)

Multi-Spellentafel (1-3-2) Standaard

- PS.ST.GT.132 Multi Gaming table (1-3-2) Standard
- PS.STAB.GT.132 Multi Gaming table (1-3-2) Standard Anthracite-Concrete

Multi-Spellentafel (1-3-2) DeLuxe

- PS.DL.GT.132 Multi Gaming table (1-3-2) DeLuxe
- PS.DLAB.GT.132 Multi Gaming table (1-3-2) DeLuxe Anthracite-Concrete

Foot Volleyball Table

- VV.GR Concrete Foot Volleyball Table Green
- VV.BL Concrete Foot Volleyball Table Blue
- VV.A Concrete Foot Volleyball Table Anthracite
- VV.NT Foot Volleyball Table Natural Concrete
- VV.AB Foot Volleyball Table Anthracite-Concrete

Bench Standard

- BB.ST Bench Standard Natural Concrete
- BB.ST.A Concrete Bench Standard Anthracite
- BB.ST.AB Bench Standard Anthracite-Concrete

Our products are delivered from our factory in the Netherlands.

Reparatieset Pingpongtafels

- HB.Repair.PP.GR Repair Kit table tennis green
- HB.Repair.PP.BL Repair kit ping pong table Blue
- HB.Repair.PP.A Repair Kit ping pong table Anthracite
- HB.Repair.AB Repair kit Anthracite-Concrete

Rounded

- PP.AR.GR Concrete Ping-pong table green, rounded
- PP.AR.BL Blue table tennis table, rounded
- PP.AR.A Concrete Ping-pong table anthracite, rounded
- PP.AR.AB Ping-pong table rounded, Anthracite-Concrete
- PP.AR.NT Ping-pong table rounded, Natural Concrete

Oval Standard

- PS.ST.OV Picnic table Standard Oval Natural Concrete
- PS.STAB.OV Picnic table Standard Oval Anthracite-Concrete
- PS.STA.OV Concrete Picnic table Standard Oval Anthracite

Normaal

- OP.PS Bottom plate Picnic table Natural Concrete
- OP.PS.AB Bottom plate Picnic table Anthracite-Concrete

Table Tennis Table

- B.DS.SP Starter package table tennis bats & balls
- B.S1 Plastic all-weather table tennis paddles in 4 colours
- B.DS10 box with 10 sets of table tennis bats
- B.S1.pastel Table tennis bats Pastel, set of 4
- B.Z6 Bag with 6 ping-pong balls
- B.DS100 Box of ping-pong balls packed per 100 pieces

Verf (1 Liter)

- HB.Paint-6009 1 Liter Green paint
- HB.Paint-5005 1 Liter Blue paint
- HB.Paint-7016 1 liter anthracite paint
- HB.Paint-white 1 liter white paint

Football Table

- HB.FB.A Concrete Table Football Table

Dambanken

- BB.CK Checkers/Drafts Bench, Natural Concrete
- BB.CK.AB Checkers/Drafts Bench, Anthracite-Concrete

Our products are delivered from our factory in the Netherlands.

Schaaktafel 2 persoons

- GT.CH.2 Chess Table Natural Concrete (2P)
- GT.CH.AB2 Chess Table Anthracite-Concrete (2P)

Damtafel 4 persoons

- GT.CK.4 Checkers/Drafts Table Natural Concrete (4P)
- GT.CK.AB4 Checkers/Drafts Table Anthracite-Concrete (4P)

Multi-Spellentafel (1-3-4) Standaard

- PS.ST.GT.134 Multi Gaming table (1-3-4) Standard
- PS.STAB.GT.134 Multi Gaming table (1-3-4) Standard Anthracite-concrete

Multi-Spellentafel (1-3-4) DeLuxe

- PS.DL.GT.134 Multi Gaming table (1-3-4) DeLuxe
- PS.DLAB.GT.134 Multi Gaming table (1-3-4) DeLuxe Anthracite-Concrete

Base Plate

- OP.PP Concrete base plate for tennis table
- OP.PP.AB Concrete base plate for tennis table Anthracite-Concrete

Bench DeLuxe

- BB.DL Bench DeLuxe Natural Concrete
- BB.DL.A Concrete Bench DeLuxe Anthracite
- BB.DL.AB Bench DeLuxe Anthracite-Concrete

High Table

- HB.ST High Table Natural Concrete
- HB.ST.A Concrete High Table Anthracite
- HB.ST.AB High Table Anthracite-Concrete

1 Liter verf

- HB.Paint-6009 1 Liter Green paint
- HB.Paint-5005 1 Liter Blue paint
- HB.Paint-7016 1 liter anthracite paint
- HB.Paint-white 1 liter white paint

Round

- PP.R.GR Concrete Ping-pong table green, round
- PP.R.BL Concrete Ping-pong table blue, round
- PP.R.A Round Ping-Pong table Anthracite
- PP.R.AB Round Ping-Pong table Anthracite-Concrete
- PP.R.NT Round Ping-pong table in Natural Concrete

Our products are delivered from our factory in the Netherlands.

Wheelchair Accessible Standard

- PS.ST.RT Picnic table Standard Natural Concrete Wheelchair accessible
- PS.STAB.RT Picnic table Standard Anthracite-Concrete Wheelchair accessible
- PS.STA.RT Concrete Picnic table Standard Anthracite Wheelchair accessible

Large

- OP.PS.246 Bottom plate Picnic set 246cm
- OP.PS.AB.246 Bottom plate Picnic set 246cm

Reparatieset Pingongtafels

- HB.Repair.PP.GR Repair Kit table tennis green
- HB.Repair.PP.BL Repair kit ping pong table Blue
- HB.Repair.PP.A Repair Kit ping pong table Anthracite
- HB.Repair.AB Repair kit Anthracite-Concrete

Football Table

- HB.FB.6White Set of 6 table football balls standard white
- HB.FB.25White Bag with 25 table football balls standard white
- HB.FB.DOLL Single football figure available
- HB.FBP.Set Set of football players
- HB.FBSC.set Set of kickers with scoreboard
- HB.FB.eye Eye protector for rods
- HB.FB.Eye.set8 Eyeprotectors set of 8 pieces.
- HB.FB.bumper Rubber damper
- HB.FB.Bumperset Set of rubber dampers for football table, 16 pcs.
- HB.FB.Handle Handle
- HB.FB.Handleset Handle, set of 8
- HB.FB.Rod Table football rod
- HB.FB.Rodset Stainless steel rods for football game, set of 8.

Accessories

- HB.FB.6White Set of 6 table football balls standard white
- HB.FB.25White Bag with 25 table football balls standard white
- HB.FB.DOLL Single football figure available
- HB.FBP.Set Set of football players
- HB.FBSC.set Set of kickers with scoreboard
- HB.FB.Handle Handle
- HB.FB.Handleset Handle, set of 8
- HB.FB.bumper Rubber damper
- HB.FB.Bumperset Set of rubber dampers for football table, 16 pcs.
- HB.FB.eye Eye protector for rods
- HB.FB.Eye.set8 Eyeprotectors set of 8 pieces.

Our products are delivered from our factory in the Netherlands.

- HB.FB.Rod Table football rod
- HB.FB.Rodset Stainless steel rods for football game, set of 8.
- FB.S30 set13 Screw + nut for dolls 30 mm (13)
- FB.S35 set8 Bolts + Nuts eye protectors 35 mm, 8 pieces

Base Plate

- OP.BB Universal Base plate for Benches
- OP.BB.AB Universa, Base plate for Benches, anthracite-concrete

Backgammonbanken

- BB.BG Backgammon Bench, Natural Concrete
- BB.BG.AB Backgammon Bench, Anthracite-Concrete

Damtabel 2 persoons

- GT.CK.2 Checkers/Drafts Table Natural Concrete (2P)
- GT.CK.AB2 Checkers/Drafts Table Anthracite-Concrete (2P)

Ludo-tafel 4 persoons

- GT.LD.4 Ludo Game Table Naturel Concrete (4P)
- GT.LD.AB4 Ludo Game Table Anthracite-Concrete (4P)

Multi-Spellentafel (1-1-1) Standaard

- PS.ST.GT.111 Multi-Game Table (1-1-1) Standard
- PS.STAB.GT.111 Multi Gaming table (1-1-1) Standard Anthracite-concrete

Multi-Spellentafel (1-1-1) DeLuxe

- PS.DL.GT.111 Multi Gaming table (1-1-1) DeLuxe

Support Blocks

- OV.PP.SET A set of support blocks for different tables
- OVAB.PP.SET Anthracite-Concrete Base Set for various tables

Park Bench with Base Plate

- BB.PB.OP Park Bench with bottom plate Natural Concrete
- BB.PBAB.OP Park Bench with bottom plate Anthracite-Concrete
- BB.PB.OP.SET4 Set of 4 Park Benches with Base Plate
- BB.PBAB.OP.SET4 Set of 4 Park Benches with Base Plate, Anthracite-Concrete

Low

- PP.AR.LOW.BL Ping pong table low, rounded Blue
- PP.AR.LOW.GR Ping pong table low, rounded Green
- PP.AR.LOW.A Ping pong table low, rounded Anthracite

Our products are delivered from our factory in the Netherlands.

Rectangular DeLuxe

- PS.DL Picnic table DeLuxe
- PS.DL.A Concrete Picnic table DeLuxe Anthracite
- PS.DL.AB Picnic table DeLuxe Anthracite-Concrete

Gaming Table

- GT.CH.Pieces Set of chessmen
- GT.CK.Pieces Set of checkers/drafts
- GT.LD.Pieces Set of pawns with a dice
- GT.BG.pieces Backgammon stones and dice

Backgammontafel 2 persoons

- GT.BG.2 Backgammon Table Natural Concrete (2P)
- GT.BG.AB2 Backgammon Table Anthracite-Concrete (2P)

Backgammontafel 4 persoons

- GT.BG.4 Backgammon Table Natural Concrete (4P)
- GT.BG.AB4 Backgammon Table Anthracite-Concrete (4P)

Bench Standard Oval

- BB.ST.OV Bench natural concrete oval
- BB.STAB.OV Bench standard oval anthracite-concrete
- BB.STA.OV Bench standard oval anthracite

Base Plate

- OP.PP Concrete base plate for tennis table
- OP.PP.AB Concrete base plate for tennis table Anthracite-Concrete

Oval DeLuxe

- PS.DL.OV Picnic table DeLuxe Oval Natural Concrete
- PS.DL.A.OV Concrete Picnic table DeLuxe Oval Anthracite
- PS.DL.AB.OV Picnic table DeLuxe Oval Anthracite-Concrete

Bench DeLuxe Oval

- BB.DL.OV Bench DeLuxe Oval Natural Concrete
- BB.DL.A.OV Concrete Bench DeLuxe Oval Anthracite
- BB.DL.AB.OV Bench DeLuxe Oval Anthracite-Concrete

Support Blocks

- OV.PP.SET A set of support blocks for different tables
- OVAB.PP.SET Anthracite-Concrete Base Set for various tables

Our products are delivered from our factory in the Netherlands.

Wheelchair Accessible DeLuxe

- PS.DL.RT Picnic table DeLuxe Natural Concrete Wheelchair accessible
- PS.DLA.RT Concrete Picnic table DeLuxe Anthracite Wheelchair accessible
- PS.DLAB.RT Picnic table DeLuxe Anthracite-Concrete Wheelchair accessible

Picknick Tables

- PS.Plank Bamboo planks
- PS.Plank.OV Set of oval bamboo planks

Park Bench Duo

- BB.PB.DUO Parkbench Duo Concrete
- BB.PBAB.DUO Park Bench Duo anthracite-concrete
- BB.PB.DUO.SET Park bench Duo set of 4 pieces
- BB.PBAB.DUO.SET Park bench Duo in Anthracite-Concrete set of 4 set of 4 pieces

Large (246cm) Standard

- PS.ST.246 Picnic set Standard 246cm
- PS.STA.246 Picnic set Standard Anthracite 246cm
- PS.STAB.246 Picnic set Standard Anthracite-Concrete 246cm

Benches

- PS.Plank Bamboo planks
- PS.Plank.OV Set of oval bamboo planks

Accessories

- GT.LD.Pieces Set of pawns with a dice
- GT.CH.Pieces Set of chessmen
- GT.CK.Pieces Set of checkers/drafts
- GT.BG.pieces Backgammon stones and dice

Bench DeLuxe with backrest

- BB.DL.ML Bench DeLuxe with backrest Natural Concrete
- BB.DLA.ML Concrete bench DeLuxe with backrest Anthracite
- BB.DLAB.ML Bench DeLuxe with backrest Anthracite-Concrete

Accessoires

- B.DS.SP Starter package table tennis bats & balls
- B.S1 Plastic all-weather table tennis paddles in 4 colours
- B.DS10 box with 10 sets of table tennis bats
- B.S1.pastel Table tennis bats Pastel, set of 4
- B.Z6 Bag with 6 ping-pong balls
- B.DS100 Box of ping-pong balls packed per 100 pieces

Our products are delivered from our factory in the Netherlands.

Large (246cm) DeLuxe

- PS.DL.246 Picnic set DeLuxe 246cm
- PS.DLA.246 Picnic set DeLuxe Anthracite 246cm
- PS.DLAB.246 Picnic set DeLuxe Anthracite-Concrete 246cm

Base Plates

- OP.PS Bottom plate Picnic table Natural Concrete
- OP.PS.AB Bottom plate Picnic table Anthracite-Concrete

Bench DeLuxe with Base Plate

- BB.DL.OP.ZL Bench DeLuxe with bottom plate without backrest Natural Concrete
- BB.DLA.OP.ZL Concrete bench DeLuxe with bottom plate without backrest Anthracite
- BB.DLAB.OP.ZL Bench DeLuxe with bottom plate without backrest Anthracite-Concrete

XL Standard

- PS.ST.XL Picnic table Standard XL Natural Concrete
- PS.STA.XL Concrete Picnic table Standard XL Anthracite
- PS.STAB.XL Picnic table Standard XL Anthracite-Concrete

Bench DeLuxe with Base Plate with Backrest

- BB.DL.OP Bench DeLuxe with bottom plate and backrest Natural Concrete
- BB.DLA.OP Concrete bench DeLuxe with bottom plate and backrest Anthracite
- BB.DLAB.OP Bench DeLuxe with bottom plate and backrest Anthracite-Concrete

Base Plates

- OP.PS Bottom plate Picnic table Natural Concrete
- OP.PS.AB Bottom plate Picnic table Anthracite-Concrete
- OP.PS.246 Bottom plate Picnic set 246cm
- OP.PS.AB.246 Bottom plate Picnic set 246cm

Base Plates

- OP.BB Universal Base plate for Benches
- OP.BB.AB Universa, Base plate for Benches, anthracite-concrete

Parts

- PS.Plank Bamboo planks
- PS.Plank.OV Set of oval bamboo planks

Parts

- PS.Plank Bamboo planks
- PS.Plank.OV Set of oval bamboo planks

Our products are delivered from our factory in the Netherlands.



Concrete Ping-pong table blue

Product code: PP.BL

£ 2,800.00 excl. VAT
(£ 3,360.00 incl. VAT)

Table tennis tables from HeBlad

Who hasn't heard of them: the table tennis tables from HeBlad? And who doesn't know the game? Playing table tennis at the campsite, table tennis on the schoolyard, hanging out on the table by the pool; they are all fun things to do! Our table tennis tables are made in one piece. The base, playing surface and net cannot be separated. This guarantees for a long lifespan and makes the table unattractive to vandalism. Win-win!

What to look for with a table tennis table?

The most important things to take into account are your wishes, but safety and space are not to be overlooked. Which shape appeals to you, and which colour is your favourite? Will many smaller children be using the table tennis table? Then it would make sense to go for the safer option; with rounded corners and a lowered table top, or maybe the completely round table would be best. Naturally the available space on your site determines which table is most suitable.

Which colour table tennis table do you choose?

This concrete ping pong table is the blue version of the classic green model. A blue two-component paint was used to finish the surface, while the lines and concrete net are coloured in the well-known and recognizable white colour. Depending on the environment in which the table is placed, you may choose this blue version, but also the classic green, natural concrete, anthracite concrete or anthracite. Plenty of choices, all at the same level of quality.

3 April 2025 - Prices subject to change

Our products are delivered from our factory in the Netherlands.

What material is the HeBlad table tennis table made of?

The concrete that the HeBlad table tennis tables, and all other HeBlad products, are made of, gives the tables a robust sturdiness. This allows the tables to survive any and all weather conditions. This way your customers or pupils will have fun for years to come. The concrete and the reinforcements at the top and bottom provide the necessary strength to the table, and make it difficult to move. So you won't have to worry about theft! Once you purchase a HeBlad device, you will enjoy playing for years to come. This is not just some disposable table. We like to keep our planet in mind, and it asks for sustainability.

Delivery of the blue concrete ping pong table

To encourage table tennis fun and promote sustainability, we also deliver this blue concrete table tennis table to you free of charge. Read about the conditions for delivery on this page. Are you unsure whether your location meets the conditions? Contact us and we will discuss the possibilities together. Because HeBlad produces the game tables and benches in our own factory in the Netherlands, the devices are often available from stock. This way we can guarantee a delivery time of up to four weeks. Our average delivery time is only 10 working days!

** When purchasing a HeBlad ping pong table, a set of bats (4 bats and 2 balls) is included for free.

Our products are delivered from our factory in the Netherlands.

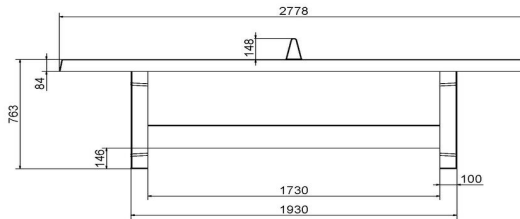
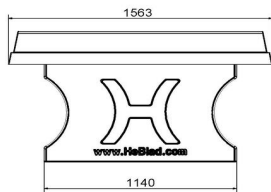
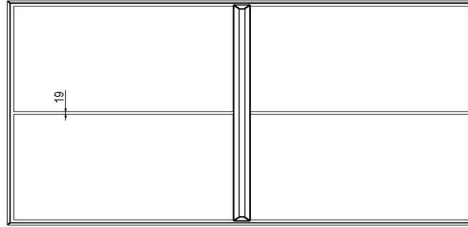
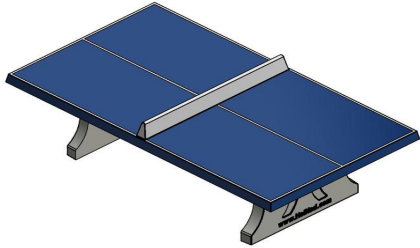

HeBlad
www.HeBlad.com
PP.BL
Gewicht ± 1360 KG

Specifications Concrete Ping-pong table blue

Product code	PP.BL	Height tabletop	76 cm
Colour	Blue - RAL 5005	Height of the net	14,75 cm
Dimension playing surface (L x W)	274 x 152 cm	Weight	1360 kg
Dimensions bottom of playing surface	278 x 156 cm	Distance legs	183 cm (center to center)
Tabletop thickness	8,4 cm		

Related products



PP.AR.GR



PP.R.NT



OP.PP



B.DS10

Our products are delivered from our factory in the Netherlands.



Concrete Ping-pong table green

Product code: PP.GR

£ 2,800.00 excl. VAT
(£ 3,360.00 incl. VAT)

The classic rectangular table tennis table from HeBlad with a green lacquered playing surface, who hasn't heard of it? Where are our table tennis tables located? For more than twenty years we've been supplying concrete table tennis tables to schools, campsites, swimming pools and institutions throughout the Netherlands and now also in neighbouring countries. The concrete table tennis tables, but our other products such as the foot volleyball table, the game table and the table football tables as well, provide endless outdoor fun.

Where does table tennis come from?

The game of table tennis has been around for a long time. It emerged in England at the end of the 19th century as a derivative of regular tennis. Fortunately, the new generations also know where to find the table tennis table; at schools, campsites and neighbourhood fields. The concrete table tennis tables from HeBlad are weather-resistant and rock-solid. A super strong and therefore durable playground equipment, an asset to any public or busy outdoor space.

Solid one-piece concrete table tennis tables

HeBlad table tennis tables are always cast from one piece of concrete. This means that there are no loose parts, no nuts or bolts involved. The tables can therefore not be dismantled. That is what makes them so solid and robust. The playing surface of this variant is green. The top layer in colour is also strong. After a thorough primer, all concrete table tennis tables are spray-painted with a two-component paint in, for example, green (RAL 6009) or blue (RAL 5005). The

3 April 2025 - Prices subject to change

Our products are delivered from our factory in the Netherlands.

table defies all seasons and is resistant to all weather influences. The top layer is very wear-resistant.

Concrete table tennis tables in different sizes

Are you looking for a table tennis table? Then you can choose from different sizes, colors and models. In addition to this classic green table tennis table, we have variants with rounded corners and also completely round ping pong tables. These round variants have a diameter of 2.60 meters. Have you decided on which model you would like to purchase? Then think about which color best suits your environment. You can choose from the colors blue, green, natural concrete, anthracite and anthracite concrete.

The advantages of our concrete table tennis tables:

- Low maintenance
- Durable
- Strong and robust
- Encourages playing outside
- Provides for fun and teamwork
- You order directly from the manufacturer and supplier!

Questions about table tennis tables?

Do you have any questions about our concrete table tennis tables or any of our other products? Please feel free to contact us. Perhaps even take a look at our frequently asked questions and information about the delivery of our products. We guarantee you years of fun when you purchase this table tennis table.

** When purchasing a HeBlad table tennis table, a set of bats (4 bats and 2 balls) is included for free.

Our products are delivered from our factory in the Netherlands.

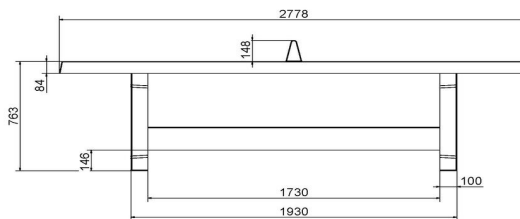
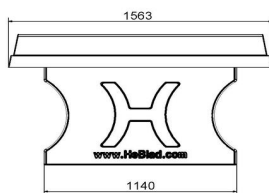
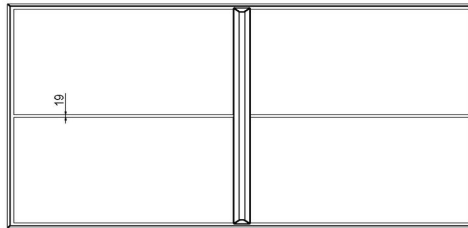
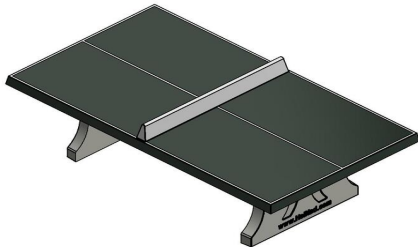

HeBlad
www.HeBlad.com
PP.GR
Gewicht ± 1360 KG

Specifications Concrete Ping-pong table green

Product code	PP.GR	Height tabletop	76 cm
Colour	Green - RAL 6009	Height of the net	14,75 cm
Dimension playing surface (L x W)	274 x 152 cm	Weight	1360 kg
Dimensions bottom of playing surface	278 x 156 cm	Distance legs	183 cm (center to center)
Tabletop thickness	8,4 cm		

Related products



PP.AR.BL



PP.R.NT



B.S1



OP.PP



B.DS.SP

Our products are delivered from our factory in the Netherlands.



Concrete Ping-pong table anthracite

Product code: PP.A

£ 2,800.00 excl. VAT
(£ 3,360.00 incl. VAT)

The classic rectangular table tennis table from HeBlad with an anthracite lacquered playing surface. Who hasn't heard of it? We have been delivering these concrete ping-pong tables to schools, campsites, swimming pools and institutions throughout the Netherlands for more than twenty years now, with the recent addition of delivery to neighbouring countries. The concrete table tennis tables, but our other products as well, such as the foot volleyball table, the game table and the table football table, provide endless outdoor fun.

The game of table tennis has been around for a long time, but the new generation also knows where to find the table tennis table; at schools, campsites and neighborhood fields. This concrete ping pong table is weather-resistant and rock-solid. A super strong and therefore durable playground equipment, an asset to any public or busy outdoor space.

One-piece concrete table tennis tables

HeBlad table tennis tables are always cast from one piece of concrete. This means that there are no loose parts, no nuts or bolts involved. The tables cannot be dismantled. That is what makes them so solid and robust. The playing surface of this variant is anthracite. This top layer in colour is also strong. After a thorough primer, all concrete table tennis tables are sprayed with a two-component paint in, for example, anthracite (RAL 7016), green (RAL6009) or blue (RAL 5005). The table defies all seasons and is resistant to all weather influences. The top layer is very wear-resistant.

Concrete table tennis tables in different sizes

3 April 2025 - Prices subject to change

Our products are delivered from our factory in the Netherlands.

Are you looking for a table tennis table? Then you can choose from different sizes, colours and models. In addition to this chic, anthracite table tennis table, we have variants with rounded corners and also completely round ping pong tables. These round variants have a diameter of 2.60 meters. Have you decided on which model you are going to choose? Then please consider which colour best suits your environment. You can choose from the colours blue, green, anthracite, natural concrete and anthracite concrete.

The advantages of our concrete table tennis tables:

- Low maintenance
- Durable
- Strong and robust
- Encourages outdoor play
- Provides fun and teamwork
- You order directly from the supplier!

Questions about table tennis tables?

Do you have any questions about our concrete table tennis tables or any of our other products? Please feel free to contact us, or look at our frequently asked questions and information about the delivery of our products. We guarantee you years of fun when you purchase this ping pong table.

** When purchasing a HeBlad ping pong table, a set of bats (4 bats and 2 balls) is included for free.

Our products are delivered from our factory in the Netherlands.

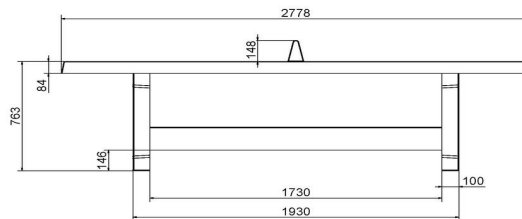
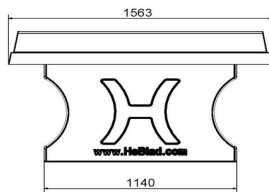
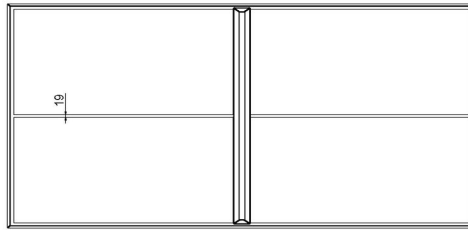
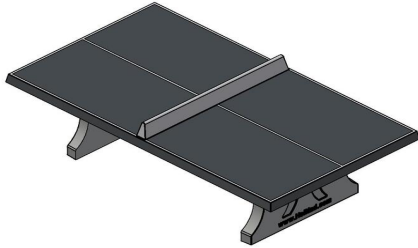

HeBlad
www.HeBlad.com
PP.A
Gewicht ± 1360 KG

Specifications Concrete Ping-pong table anthracite

Product code	PP.A	Height tabletop	76 cm
Colour	Anthracite - RAL 7016	Height of the net	14,75 cm
Dimension playing surface (L x W)	274 x 152 cm	Weight	1360 kg
Dimensions bottom of playing surface	278 x 156 cm	Distance legs	183 cm (center to center)
Tabletop thickness	8,4 cm		

Related products



PP.GR



PP.AB



HB.FB.A



B.DS.SP



B.DS10

Our products are delivered from our factory in the Netherlands.



Ping-pong table in natural concrete

Product code: PP.NT

£ 2,750.00 excl. VAT
(£ 3,300.00 incl. VAT)

The concrete table tennis table in natural concrete from HeBlad has a calm and natural colour, which makes the table suitable for any environment.

Is the concrete table tennis table durable?

In addition to its natural appearance, the table tennis table is also very durable. Its robust appearance shows exactly how sturdy the concrete table tennis table in natural concrete actually is. It is cast from one piece of concrete and made of the strongest material. The concrete makes the table resistant to all weather influences and not susceptible to vandalism. A true addition to any place where table tennis can be played. The table will make your outdoor area, camping site or playground even more beautiful and ensure years of pleasant use.

What variants does the concrete table tennis table have?

Naturally, we respond to your wishes in our multitude of choices. Do you opt for the standard concrete table tennis table in natural concrete or do you opt for the slightly safer variant of rounded natural concrete? The rounded corners decrease the risk of injury slightly, but the visual may also just be more to your taste. We provide a version in round natural concrete, for true table tennis enthusiasts. This increases safety and play possibilities, so the players can really go wild!

All versions of this concrete ping pong table are made from one piece of concrete, and have the same robustness and strength. You can easily order the natural concrete table tennis table online, this also applies to the other variants.

3 April 2025 - Prices subject to change

Our products are delivered from our factory in the Netherlands.



correspondence address

HeBlad - UK

The Balance, 7th floor, Pinfold Street
S1 2GU Sheffield, South Yorkshire
T. 0114 352 0110
info@HeBlad.co.uk
www.HeBlad.co.uk

head office address

HeBlad BV

Diamantweg 22
NL - 5527 LC Hapert

What colours is the concrete table tennis table available in?

Did you know that the concrete table tennis table is also available in various other colours? Which colour best suits your environment? Are you going for blue, green, anthracite concrete or anthracite? A version for every taste, meanwhile maintaining fun and of course our high quality.

We produce the tables in-house and deliver the table tennis table to location ourselves. This way we can offer you top quality. Please inquire about our delivery conditions. If you have any questions about what is possible at your location, please contact us. We are happy to advise you and think along with you. You have come to the right place for game tables made of quality concrete.

Our products are delivered from our factory in the Netherlands.

Registered under: HeBlad BV • HM Revenue and Customs • Ruby House 8 • Ruby Place • AB10 1ZP Aberdeen
VAT Number GB381060225 • EORI Number GB381060225000 • Commercial register (NL) 170 66 364
Rabobank De Kempen, Markt 7, 5531 BA Bladel (NL) • BIC RABONL2U • Branch code RABONL2UXXX • IBAN NL 20 RABO 0107530112 GBP

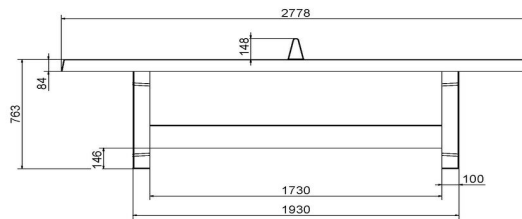
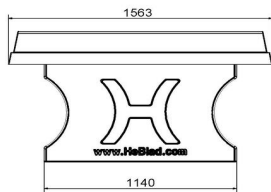
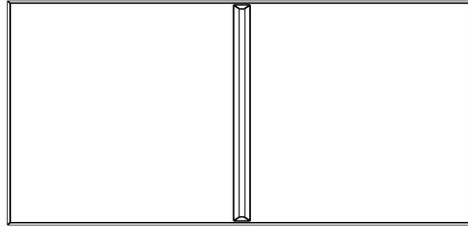
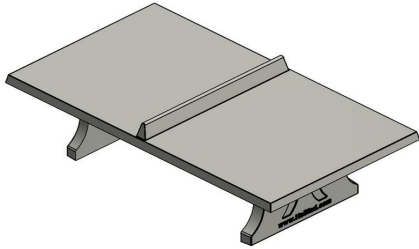

HeBlad
www.HeBlad.com
PP.NT
Gewicht ± 1360 KG

Specifications Ping-pong table in natural concrete

Product code	PP.NT	Height tabletop	76 cm
Colour	Natural concrete	Height of the net	14,75 cm
Dimension playing surface (L x W)	274 x 152 cm	Weight	1360 kg
Dimensions bottom of playing surface	278 x 156 cm	Distance legs	183 cm (center to center)
Tabletop thickness	8,4 cm		

Related products



PP.AR.GR



PP.R.BL



B.S1



OP.PP



B.DS.SP

Our products are delivered from our factory in the Netherlands.



Ping-pong table Anthracite-Concrete

Product code: PP.AB

£ 2,900.00 excl. VAT
(£ 3,480.00 incl. VAT)

At HeBlad we want to meet the wishes of as many people as possible. Would you like a ping pong table, but not as striking as blue or green? Then this table in anthracite concrete might be something for you. Just like our other table tennis tables, this table is made entirely of concrete and consists of one piece. Guaranteed fun!

Sustainable table tennis table

What makes HeBlad products so sustainable? HeBlad table tennis tables are super strong and resistant to various weather conditions. The robust tables weighing 1360 kg cannot be easily moved and can certainly withstand a blow. A HeBlad table is purchased once and can then be used countless times. A truly sustainable choice. Together we go for sustainability!

Combine table tennis table

Can the table tennis table be combined? This rectangular table tennis table is usually used by 2 to 4 people. Do you like to play with several people? Then a number of people will have to wait. Provide a comfortable waiting space by placing two benches on the long side of the table. Waiting players can take a seat here and still experience the fun of the game. Would you rather play table tennis with more people at the same time and play a game 'around the table'? Then choose the round table tennis table or the table tennis table with rounded corners.

Calmer appearance

3 April 2025 - Prices subject to change

Our products are delivered from our factory in the Netherlands.



correspondence address

HeBlad - UK

The Balance, 7th floor, Pinfold Street
S1 2GU Sheffield, South Yorkshire
T. 0114 352 0110
info@HeBlad.co.uk
www.HeBlad.co.uk

head office address

HeBlad BV

Diamantweg 22
NL - 5527 LC Hapert

The colour of the table tennis table gives the table a calmer and more natural appearance, which makes it look great in a wooded area, or on the square at business premises. Employees can go outside during their lunch break and play a game together. The natural colour ensures that the table can easily be combined with its environment. This table is also available in natural concrete, amongst other colours. Which colour ping pong table is the best choice? This completely depends on your taste and the environment in which the table will be placed.

Ping pong table supplied free of charge

HeBlad produces these tables in our own factory. This is the reason why they can often be delivered from stock, usually to be delivered within 4 weeks. As a service, we provide the delivery completely free of charge and we make sure to secure the right placement for your table. You will find more information and videos about our delivery process on our website. It is important for delivery that the location is easily accessible. You can read more about this in our terms and conditions.

Why HeBlad concrete tables:

- Easy to maintain
- Sustainable choice
- Vandalism-proof
- Encourages outdoor play
- Provides fun and teamwork
- You order directly from the supplier here!

Would you like more information about this table tennis table or do you have questions about the delivery of this product? Please feel free to contact us and we will discuss the possibilities.

** When purchasing a HeBlad ping pong table, a set of bats (4 bats and 2 balls) is included for free.

Our products are delivered from our factory in the Netherlands.

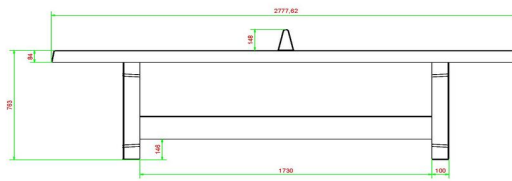
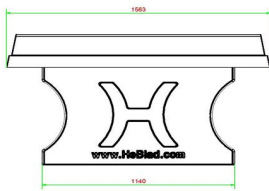
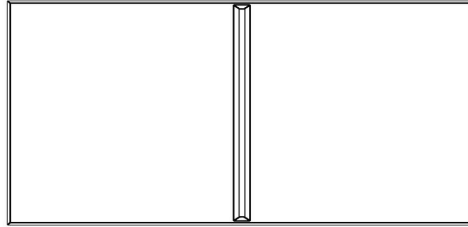
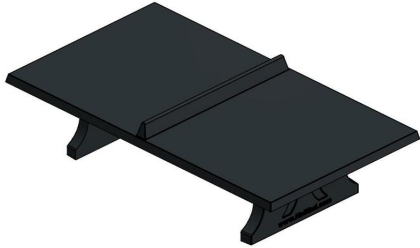

HeBlad
www.HeBlad.com
PP.AB
Gewicht ± 1360 KG

Specifications Ping-pong table Anthracite-Concrete

Product code	PP.AB	Height tabletop	76 cm
Colour	Anthracite concrete	Height of the net	14,75 cm
Dimension playing surface (L x W)	274 x 152 cm	Weight	1360 kg
Dimensions bottom of playing surface	278 x 156 cm	Distance legs	183 cm (center to center)
Tabletop thickness	8,4 cm		

Related products



PP.AR.AB



PP.GR



PP.R.BL



OP.PS.AB



B.DS.SP

Our products are delivered from our factory in the Netherlands.



Picnic table Standard Natural Concrete

Product code: PS.ST

£ 2,550.00 excl. VAT
(£ 3,060.00 incl. VAT)

You can find a picnic set anywhere. At a playground, in nature, on a schoolyard or in the woods. A concrete picnic table with benches is a nice place to catch up with someone, take a break or play with children. Are you interested in a concrete picnic table? You can find various picnic sets on our website.

Different variants of the concrete picnic table

There are different variants of the standard concrete picnic set. There are 3 colour variants: Natural Concrete, Anthracite lacquered and Anthracite-Concrete. You can purchase your concrete picnic set with or without the base plate. There are also two different shapes. This set has a rectangular shape but we also supply oval picnic tables. All concrete picnic tables are cast in one piece, the picnic sets are made from high-quality C45/55 concrete and have double reinforcement, so you can enjoy your picnic set for as long as possible.

Quality of the concrete picnic table

Because of its sturdiness, this concrete picnic table is suitable for any public location. Picnic tables made from other materials often don't last too long. The quality of our picnic tables ensures years of use and seating pleasure.

Base plate for picnic set

You can optionally order the concrete base plates. By using the base plate, the picnic set is guaranteed to be stable. A base plate comes in handy in rainy and/or muddy weather. The base plates prevent too much dirt from getting onto the

3 April 2025 - Prices subject to change

Our products are delivered from our factory in the Netherlands.



correspondence address

HeBlad - UK

The Balance, 7th floor, Pinfold Street
S1 2GU Sheffield, South Yorkshire
T. 0114 352 0110
info@HeBlad.co.uk
www.HeBlad.co.uk

head office address

HeBlad BV

Diamantweg 22
NL - 5527 LC Hapert

picnic set itself. Maintenance around the picnic set is also a lot easier; where the base plate is placed, no weeds can grow. The base plate is placed level into the ground, so you can easily mow the grass without it getting in the way.

Picnic set Standard or DeLuxe

This set of the concrete picnic table with benches is a standard set. We also supply the 'DeLuxe' variant. A Deluxe picnic set has bamboo seats and Deluxe benches have bamboo backrests. We value durability and sustainability, and we desire our products to reflect this. The bamboo seats are of high quality, like all our products are.

Questions

Do you have questions about the concrete picnic table or any other product? Please take a look at our frequently asked questions or feel free to contact us. We will be happy to help you.

Our products are delivered from our factory in the Netherlands.

Registered under: HeBlad BV • HM Revenue and Customs • Ruby House 8 • Ruby Place • AB10 1ZP Aberdeen
VAT Number GB381060225 • EORI Number GB381060225000 • Commercial register (NL) 170 66 364
Rabobank De Kempen, Markt 7, 5531 BA Bladel (NL) • BIC RABONL2U • Branch code RABONL2UXXX • IBAN NL 20 RABO 0107530112 GBP

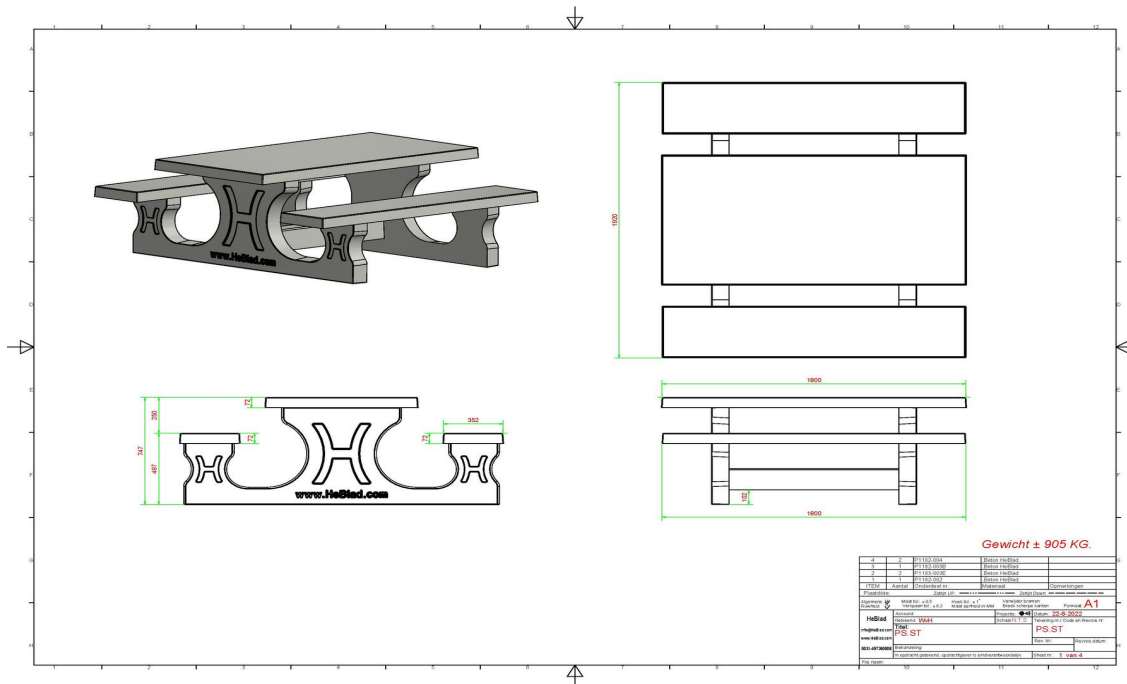

Specifications Picnic table Standard Natural Concrete

Product code	PS.ST	Seat height	50 cm
Colour	Natural concrete	Material seat	Beton
Dimensions (L x W x H)	180 x 192 x 75 cm	Distance legs	111 cm (center to center)
Dimensions tabletop (L x W)	180 x 90 cm	Weight	905 kg
Tabletop thickness	7 cm	Number of seats	8
Height tabletop	75 cm		

Related products



PS.ST.AB



PS.ST.A



PS.DL



OP.PS



PS.ST.OV

Our products are delivered from our factory in the Netherlands.



Picnic table Standard Anthracite-Concrete

Product code: PS.ST.AB

£ 2,700.00 excl. VAT
(£ 3,240.00 incl. VAT)

Robust concrete and cast in one piece, yet a very refined appearance. This standard anthracite concrete picnic set provides seating for your visitors, is weather-resistant and serve as a true eye-catcher. Destruction of the picnic set is not plausible due to the strength and weight of the set. This means that the product will retain its chic appearance for years to come and you can enjoy the picnic set all the while.

Specifications of Picnic Set Standard

The picnic sets from HeBlad have the perfect seat height of 50 cm and the ideal table height of 75 cm. The size of the complete set is 180 x 192 x 75 cm and it has a weight of 905 kg. Because the anthracite colour is incorporated into the concrete, the colour will always remain beautiful, even in the case of damage. Weather and vandalism have no influence on this picnic set, which makes it ideal for years of intensive outdoor use and can easily be placed in an unattended location.

Picnic sets and ping pong tables from HeBlad

HeBlad became big through the production of ping pong tables, but is now so much more. We are making more and more products for the outdoors, all include the reliability you have come to expect from us. Our unity in design is why it's easy to combine our products when you have the room. This way you can place the standard anthracite concrete picnic set perfectly next to the anthracite concrete ping pong table. With the same naturally chic look you give your site an extra dimension. The ping pong table round anthracite concrete or the ping pong

3 April 2025 - Prices subject to change

Our products are delivered from our factory in the Netherlands.



correspondence address

HeBlad - UK

The Balance, 7th floor, Pinfold Street
S1 2GU Sheffield, South Yorkshire
T. 0114 352 0110
info@HeBlad.co.uk
www.HeBlad.co.uk

head office address

HeBlad BV

Diamantweg 22
NL - 5527 LC Hapert

table rounded anthracite concrete also match this picnic set perfectly because of the colour and appearance.

Ask your questions about the picnic sets

Due to the size of the picnic sets, it is good to be sure whether the table actually fits on your site and whether it can be placed. For this we refer you to the delivery conditions or advise you to contact HeBlad.

Our products are delivered from our factory in the Netherlands.

Registered under: HeBlad BV • HM Revenue and Customs • Ruby House 8 • Ruby Place • AB10 1ZP Aberdeen
VAT Number GB381060225 • EORI Number GB381060225000 • Commercial register (NL) 170 66 364
Rabobank De Kempen, Markt 7, 5531 BA Bladel (NL) • BIC RABONL2U • Branch code RABONL2UXXX • IBAN NL 20 RABO 0107530112 GBP

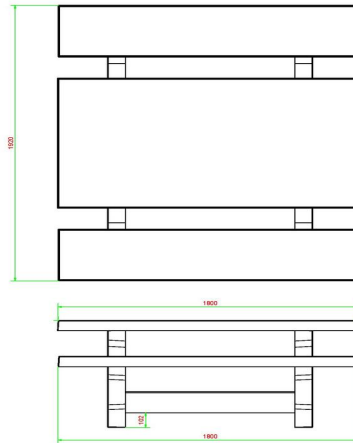
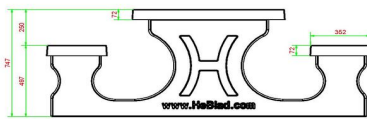

HeBlad
www.HeBlad.com
PS.ST.AB
± 905 KG.

Specifications Picnic table Standard Anthracite-Concrete

Product code	PS.ST.AB	Seat height	50 cm
Colour	Anthracite concrete	Material seat	Beton
Dimensions (L x W x H)	180 x 192 x 75 cm	Distance legs	111 cm (center to center)
Dimensions tabletop (L x W)	180 x 90 cm	Weight	905 kg
Tabletop thickness	7 cm	Number of seats	8

Related products 75 cm



PS.ST



PS.ST.A



PS.DLAB



OP.PS.AB



PS.STAB.OV

Our products are delivered from our factory in the Netherlands.



Concrete Picnic table Standard Anthracite

Product code: PS.ST.A

£ 2,650.00 excl. VAT
(£ 3,180.00 incl. VAT)

With how sleek the appearance is, this picnic set seems to be made of plastic. However, nothing could be further from the truth. This set is made of a single piece of concrete and then spray painted with lacquer in an anthracite colour. This makes the table easy to clean and the natural concrete look has been changed into a sleek and chic design.

Picnic set and the base plate

This beautiful picnic set standard in anthracite colour is ideal for placement at rest areas for motorists or cyclists. This table looks great at the side of the road or in a park, but also at home in your own garden. Because the table is heavy and cannot be dismantled, it is insensitive to vandalism. When the picnic set is placed on an unstable surface, we advise you to make use of the base plate. This base plate is specifically designed for this picnic set, so that the table can be placed stably on the surface. A nice bonus: the base plate makes mowing the lawn around the table easier!

Picnic sets, game tables and benches from HeBlad

If you want to turn your site into a true gaming palace, then you have come to the right place! Monitored or unattended makes no difference to HeBlad products. Because our game tables, benches, ping-pong tables and picnic sets are mostly cast from a single piece of concrete, they are impervious to vandalism and are specifically designed to last for years outdoors. This allows you to easily combine multiple tables, benches and game tables on one site and you never have to worry about the usability or lifespan of your purchase.

3 April 2025 - Prices subject to change

Our products are delivered from our factory in the Netherlands.



correspondence address

HeBlad - UK

The Balance, 7th floor, Pinfold Street
S1 2GU Sheffield, South Yorkshire
T. 0114 352 0110
info@HeBlad.co.uk
www.HeBlad.co.uk

head office address

HeBlad BV

Diamantweg 22
NL - 5527 LC Hapert

Delivery of the picnic sets

Picnic sets and other robust HeBlad products are often available from stock, which means fast delivery. You can enjoy the picnic set no later than 4 working weeks after placing your order. We care about our products, so we treat them with care. This also applies when the tables and benches are transported and installed. We have drawn up a number of delivery conditions for you for this purpose. If you have any questions or doubts, always contact us.

Our products are delivered from our factory in the Netherlands.

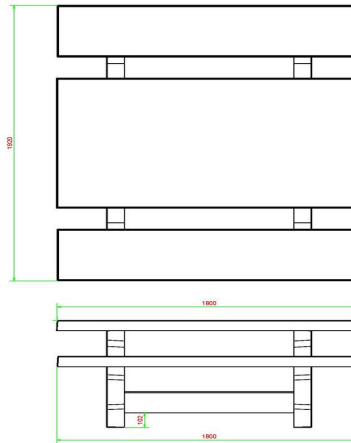
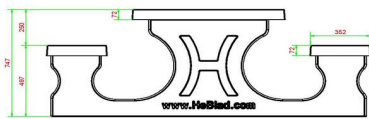

HeBlad
www.HeBlad.com
PS.ST.A
± 905 KG.

Specifications Concrete Picnic table Standard Anthracite

Product code	PS.ST.A	Seat height	50 cm
Colour	Anthracite lacquered, RAL 7016	Material seat	Beton
Dimensions (L x W x H)	180 x 192 x 75 cm	Distance legs	111 cm (center to center)
Dimensions tabletop (L x W)	180 x 90 cm	Weight	905 kg
Tabletop thickness	7 cm	Number of seats	8

Related products



PS.ST



PS.ST.AB

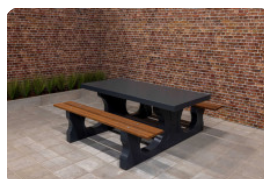

PS.DL.A



OP.PS.AB



PS.STA.OV

Our products are delivered from our factory in the Netherlands.



Chess Bench, Natural Concrete

Product code: BB.CH

£ 2,300.00 excl. VAT
(£ 2,760.00 incl. VAT)

From our line of game tables and benches, this chess bench made of natural concrete is an eye-catching product, a real gem. It does not matter whether this natural concrete chess bench is placed in a city center, at a campsite, on a schoolyard or in a park. This chess bench is resistant to vandalism and all weather influences. Made in the colour natural concrete, cast in one piece and weighing 1140 kg, this is - and remains - a more than solid beauty.

Want to rest or play a game on the chess bench?

The chess bench in natural concrete has a seat height of 50 cm and the table top is made at a height of 70 cm. The upper part is equipped with a chess surface and the table is supplied with one set of chess pieces as standard. The ideal setting to think about a game of chess against your challenger in the fresh air, to have a nice chat or to take a moment of rest during a walk. Place the concrete chess bench as an eye-catcher and it will bring people together. Sometimes for a chat, sometimes for a game, but it's always fun and free of charge.

Various designs of chess benches and game tables

Does a chess bench seem like the perfect solution for your environment? But are you unsure about the colour or design? No problem! In addition to this natural concrete version, you can also choose the colour anthracite concrete. Our extensive range of gaming tables also includes chess tables that are designed with stools instead of a bench. If you prefer to play a different game, consider our

3 April 2025 - Prices subject to change

Our products are delivered from our factory in the Netherlands.



correspondence address

HeBlad - UK

The Balance, 7th floor, Pinfold Street
S1 2GU Sheffield, South Yorkshire
T. 0114 352 0110
info@HeBlad.co.uk
www.HeBlad.co.uk

head office address

HeBlad BV

Diamantweg 22
NL - 5527 LC Hapert

checkers tables and benches, ludo tables or multi-game tables in different colours.

Accessories and loose parts for the concrete chess bench

HeBlad gaming tables are supplied as standard with a set of associated accessories. With our natural concrete chess bench you will receive a set of chess pieces. All accessories, including the chess pieces, extra anchoring sets and allen keys, can be ordered separately from HeBlad. So for complete gaming tables and all accessories you have come to the right place at HeBlad.

**When ordering one chess bench, you will receive 1 set of chess pieces.

Our products are delivered from our factory in the Netherlands.

Registered under: HeBlad BV • HM Revenue and Customs • Ruby House 8 • Ruby Place • AB10 1ZP Aberdeen
VAT Number GB381060225 • EORI Number GB381060225000 • Commercial register (NL) 170 66 364
Rabobank De Kempen, Markt 7, 5531 BA Bladel (NL) • BIC RABONL2U • Branch code RABONL2UXXX • IBAN NL 20 RABO 0107530112 GBP

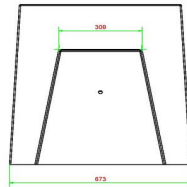
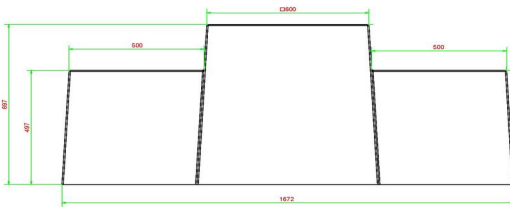
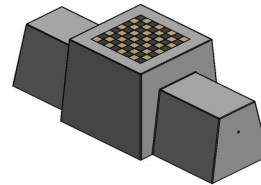
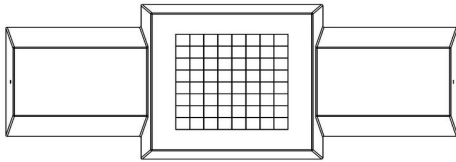

HeBlad
www.HeBlad.com
BB.CH
Gewicht ± 1140 KG.

Specifications Chess Bench, Natural Concrete

Product code	BB.CH	Height tabletop	70 cm
Colour	Natural concrete	Weight	1140 kg
Dimensions (L x W x H)	167 x 67 x 70 cm	Number of seats	2
Seat height	50 cm		

Related products



BB.CH.AB



BB.CH



GT.CH.2



GT.CH.Pieces

Our products are delivered from our factory in the Netherlands.



Chess Bench, Anthracite-Concrete

Product code: BB.CH.AB

£ 2,375.00 excl. VAT
(£ 2,850.00 incl. VAT)

The HeBlad chess bench in anthracite concrete colour has a unique design and is a jewel in its surroundings. With its robust appearance, it is a very attractive addition to any schoolyard, campsite, park or even in city centers. Due to the anthracite concrete colour, the chess bench can be very striking, but can also subtly disappear against the background.

This chess bench, like HeBlad's other game tables, is cast from a single piece of concrete, which makes it vandalism-proof and will provide you with years of playing and seating pleasure.

Anthracite concrete chess bench for play or rest

Place the concrete chess bench and create a meeting place for young and old. Because the playing surface is made at table height and has a chess surface, this bench is perfect for playing a game of chess with the included chess pieces. Meet and challenge each other. The bench height is 50 cm, the ideal seat height for taking a moment of rest during a walk, catching up with a friend or reading a book outdoors. Seating comfort in a beautiful anthracite concrete version and free of charge.

Combine concrete chess bench with other game tables

Mind sports can be combined very well with physical sports. Place another HeBlad game table in the same environment as the anthracite concrete chess bench and give users the choice of thinking, resting or exercising. How about an original HeBlad ping pong table, available in green, blue, anthracite, anthracite concrete or natural concrete? You can choose a safe ping pong table with

3 April 2025 - Prices subject to change

Our products are delivered from our factory in the Netherlands.



correspondence address

HeBlad - UK

The Balance, 7th floor, Pinfold Street
S1 2GU Sheffield, South Yorkshire
T. 0114 352 0110
info@HeBlad.co.uk
www.HeBlad.co.uk

head office address

HeBlad BV

Diamantweg 22
NL - 5527 LC Hapert

rounded corners or even a beautiful round table in any of these colours.

A picnic set next to a concrete chess bench

Expand the anthracite concrete chess bench with one or more picnic sets to provide more seating space for visitors or passers-by. Combine with the same colour or let the diversity of colours dominate.

Contact us! We are happy to help you choose.

**When ordering one chess bench, you will receive 1 set of chess pieces.

Our products are delivered from our factory in the Netherlands.

Registered under: HeBlad BV • HM Revenue and Customs • Ruby House 8 • Ruby Place • AB10 1ZP Aberdeen
VAT Number GB381060225 • EORI Number GB381060225000 • Commercial register (NL) 170 66 364
Rabobank De Kempen, Markt 7, 5531 BA Bladel (NL) • BIC RABONL2U • Branch code RABONL2UXXX • IBAN NL 20 RABO 0107530112 GBP

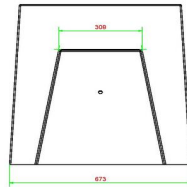
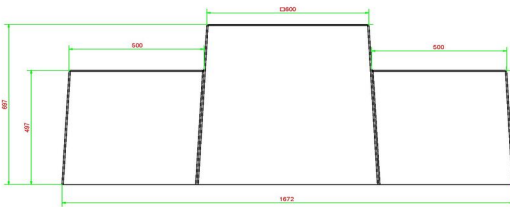
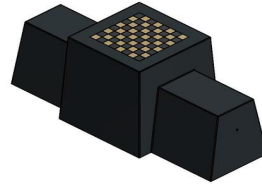
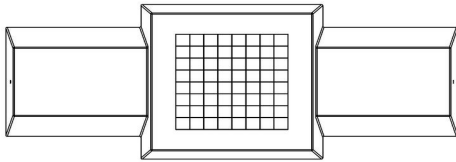

HeBlad
www.HeBlad.com
BB.CH.AB
Gewicht ± 1140 KG.

Specifications Chess Bench, Anthracite-Concrete

Product code	BB.CH.AB	Height tabletop	70 cm
Colour	Antraciet-beton	Weight	1140 kg
Dimensions (L x W x H)	167 x 67 x 70 cm	Number of seats	2
Seat height	50 cm		

Related products



BB.CH



BB.CK.AB



GT.CH.AB2



GT.CH.Pieces

Our products are delivered from our factory in the Netherlands.



Chess Table Natural Concrete (4P)

Product code: GT.CH.4

£ 3,300.00 excl. VAT
(£ 3,960.00 incl. VAT)

A pleasure to the eyes! Meet the concrete chess table made of natural concrete. The beautiful slim stools and table offer space for four people and can be used for a good game of chess, but it also provides a wonderful opportunity to catch up. A multifunctional addition to your garden, park, campsite, schoolyard or even the city center.

Specifications concrete chess table natural concrete 4 persons

This concrete chess table is made of natural concrete, which gives it its beautiful appearance. The natural stone chess fields are integrated into the concrete of the playing surface, completely according to the standards of an original chess board. The playing surface measurements are 60 x 60 cm and the table is 75 cm high. The four stools have the ideal seat height of 50 cm and, together with the table, are fixed on the concrete base plate of 10 cm thick and 149 x 149 cm (L x W). The base plate is completely integrated into the space, by removing tiles or excavating sand or grass subsoil. This way, the base fits nicely with the tiles or is placed exactly at cutting height.

Concrete chess tables in various designs

In addition to the natural concrete version, you can also opt for the 4-person variant in anthracite concrete colour. Both the anthracite-coloured game table and the natural concrete version of the chess table are available in a 2-person version.

Combine the concrete chess table with benches or picnic sets

Is your intention to make a playground, park or campsite more accessible? Would

3 April 2025 - Prices subject to change

Our products are delivered from our factory in the Netherlands.



correspondence address

HeBlad - UK

The Balance, 7th floor, Pinfold Street
S1 2GU Sheffield, South Yorkshire
T. 0114 352 0110
info@HeBlad.co.uk
www.HeBlad.co.uk

head office address

HeBlad BV

Diamantweg 22
NL - 5527 LC Hapert

you like a more sprightly site? Combine the natural concrete chess table for 4 people to your heart's content with the benches or picnic sets from HeBlad. Go for a diversity of colour and appearance or for unity, it's all possible!

* When ordering one chess bench, you will receive 1 set of chess pieces.

Our products are delivered from our factory in the Netherlands.

Registered under: HeBlad BV • HM Revenue and Customs • Ruby House 8 • Ruby Place • AB10 1ZP Aberdeen
VAT Number GB381060225 • EORI Number GB381060225000 • Commercial register (NL) 170 66 364
Rabobank De Kempen, Markt 7, 5531 BA Bladel (NL) • BIC RABONL2U • Branch code RABONL2UXXX • IBAN NL 20 RABO 0107530112 GBP

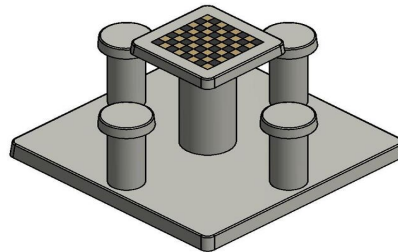
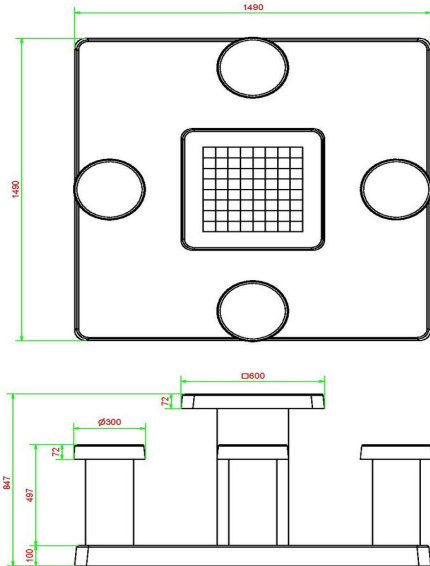

HeBlad
www.HeBlad.com
GT.CH.4

± 900 KG.

Specifications Chess Table Natural Concrete (4P)

Product code	GT.CH.4	Height tabletop	75 cm
Colour	Natural concrete	Seat height	50 cm
Dimensions (L x W x H)	149 x 149 x 85 cm	Dimensions base plate (L x W x H)	149 x 149 x 100 cm
Dimensions tabletop (L x W)	60 x 60 cm	Weight	900 kg
Tabletop thickness	7 cm		

Related products



GT.LD.AB4



GT.CH.2



BB.CK.AB



GT.CH.Pieces



PS.DLAB.GT.132

Our products are delivered from our factory in the Netherlands.



Chess Table Anthracite-Concrete (4P)

Product code: GT.CH.AB4

£ 3,500.00 excl. VAT
(£ 4,200.00 incl. VAT)

With a top of 60 x 60 cm, in which the chess field is integrated, and four seats, this chess table is, in addition to a game of chess, also very suitable for a pleasant meeting outdoors. Use the two extra seats to teach others how to play chess or pour a nice drink and use the chess table as a regular outdoor table.

Concrete outdoor chess table for 4 people

Due to the weather resistance and beautiful flamed appearance of anthracite concrete, this chess table is a subtle addition to your garden, city park or schoolyard. Thanks to the base plate of 149 x 149 cm, this anthracite concrete chess table for 4 people can always be placed solidly and incredibly sturdy in all outdoor areas. Always consider the delivery conditions or contact us and we will discuss your options.

Outdoor chess table in various designs

If the space you have at your disposal is more suitable for a smaller game table, we recommend the anthracite-concrete 2-person chess table. The table loses two seats, so you can save space and retain the grace of the chess table. Would you like to stick with this colour, but could you make it a little more sturdy and robust? Then you must have the anthracite concrete chess bench! Truly a pleasure to the eyes, equipped with the same playing surface and included chess pieces. All chess tables can also be supplied in natural concrete, you decide which colour best suits the environment. The composition, strength and weather resistance of the natural concrete chess tables and benches are the same as those of the anthracite concrete version.

3 April 2025 - Prices subject to change

Our products are delivered from our factory in the Netherlands.



correspondence address

HeBlad - UK

The Balance, 7th floor, Pinfold Street
S1 2GU Sheffield, South Yorkshire
T. 0114 352 0110
info@HeBlad.co.uk
www.HeBlad.co.uk

head office address

HeBlad BV

Diamantweg 22
NL - 5527 LC Hapert

Combine the chess table with other concrete game tables and benches

You love chess, your environment is excited by the game of chess or you want to make others enthusiastic about this mind sport. Invite the public and let them take a seat on the benches of HeBlad. Combine this game table with other game tables such as a concrete checkers table or ludo table. And of course don't forget our popular concrete table tennis table!

Please contact us

Our professionals at HeBlad are happy to tell you more about the specifications of our products and can accurately estimate the possibilities at your location.

Tips:

- The base plate is 149 x 149 cm. By removing 5x5 paving stones from the schoolyard, a space of 150 x 150 cm is created. The bottom plate of the chess table fits perfectly into this.
- If you want to place the table in a park or lawn, the surface can be excavated so that the base plate can be placed there, at cutting height.

* When ordering one chess bench you will receive 1 set of chess pieces for free.

Our products are delivered from our factory in the Netherlands.

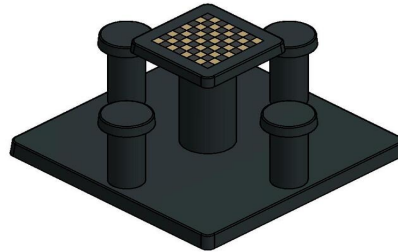
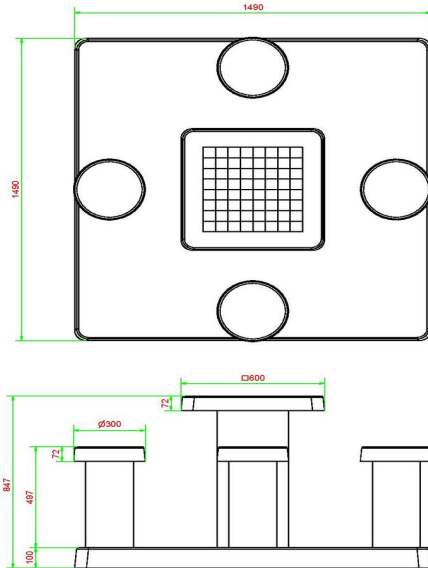

HeBlad
www.HeBlad.com
GT.CH.AB4
± 900 KG.

Specifications Chess Table Anthracite-Concrete (4P)

Product code	GT.CH.AB4	Height tabletop	75 cm
Colour	Anthracite concrete	Seat height	50 cm
Dimensions (L x W x H)	149 x 149 x 85 cm	Dimensions base plate (L x W x H)	149 x 149 x 10 cm
Dimensions tabletop (L x W)	60 x 60 cm	Weight	900 kg
Tabletop thickness	7 cm		

Related products



GT.CH.G4



GT.CK.AB2



BB.CH.AB



GT.CH.Pieces



PS.DL.GT.132

Our products are delivered from our factory in the Netherlands.



Multi Gaming table (1-3-2) Standard

Product code: PS.ST.GT.132

£ 4,000.00 excl. VAT
(£ 4,800.00 incl. VAT)

Cast from one piece of concrete, seating for at least six people and no fewer than three different game options. And all in one dazzling picnic set. Because this multi-game table comes with chess pieces, checkers and ludo pawns as standard, you are immediately assured of gaming fun. The game boards are integrated into the table top, which makes the table ideal for use as a regular picnic set when the games are not being used.

Concrete multi-game table (1-3-2) standard

The fact that the multi-game table is standard in natural concrete does not mean that it is not available in multiple colours. Like so many of HeBlad's products, this game table can also be ordered in anthracite concrete colour. For a little more seating comfort, choose the DeLuxe anthracite concrete multi-game table. The bamboo seat on the DeLuxe version gives the seating area more softness, while the bamboo is also weather resistant.

Mix with the multi-game table (1-3-2) standard

If you choose to order multiple multi-game tables at the same time, you will receive an attractive discount. Don't hesitate to contact us to inform about the options and discounts we offer when you combine multiple HeBlad products.

For a playful effect on your site, you could opt for separate game tables from HeBlad. For example, the checkers table natural concrete for 2 persons, the chess table anthracite concrete for 4 persons, the ludo table natural concrete or one of the other variants of the game tables. You decide, you choose and mix

3 April 2025 - Prices subject to change

Our products are delivered from our factory in the Netherlands.



correspondence address

HeBlad - UK

The Balance, 7th floor, Pinfold Street
S1 2GU Sheffield, South Yorkshire
T. 0114 352 0110
info@HeBlad.co.uk
www.HeBlad.co.uk

head office address

HeBlad BV

Diamantweg 22
NL - 5527 LC Hapert

according to your own wishes.

Are you not sure about the surface on which you would like to place the gaming tables? Then it is best to contact us. By determining your available space and surface, we'll know exactly what is possible on your site with the specifications of the gaming tables. Sometimes it may be necessary to use a base plate for the stability of the table. or you may even have room for additional benches or picnic sets!

Our products are delivered from our factory in the Netherlands.

Registered under: HeBlad BV • HM Revenue and Customs • Ruby House 8 • Ruby Place • AB10 1ZP Aberdeen
VAT Number GB381060225 • EORI Number GB381060225000 • Commercial register (NL) 170 66 364
Rabobank De Kempen, Markt 7, 5531 BA Bladel (NL) • BIC RABONL2U • Branch code RABONL2UXXX • IBAN NL 20 RABO 0107530112 GBP

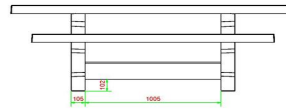
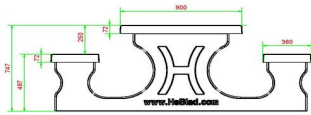
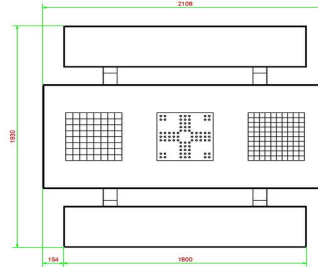
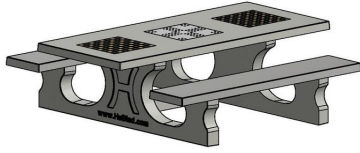

HeBlad
www.HeBlad.com
PS.ST.GT.132
± 950 KG.

Specifications Multi Gaming table (1-3-2) Standard

Product code	PS.ST.GT.132	Height tabletop	75 cm
Colour	Natural concrete	Seat height	50 cm
Dimensions (L x W x H)	210 x 193 x 75 cm	Material seat	Beton
Dimensions tabletop (L x W)	210 x 90 cm	Distance legs	111 cm (center to center)
Tabletop thickness	7 cm	Weight	950 kg

Related products



PS.DL.GT.132



PS.DLAB.GT.132



GT.CK.Pieces



OP.PS

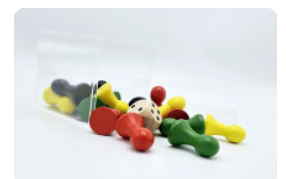

GT.LD.Pieces

Our products are delivered from our factory in the Netherlands.



Multi Gaming table (1-3-2) Standard Anthracite-Concrete

£ 4,150.00 excl. VAT
(£ 4,980.00 incl. VAT)

Product code: PS.STAB.GT.132

Never be bored again at this multi-game table made of anthracite concrete. Our multi game table is a combination of several game tables: a ludo, checkers and chess table in one. All game boards are integrated into this beautiful, anthracite-coloured concrete picnic table. The benches and table are made together from one piece of concrete and the height of both the table and the seats are perfect for sitting, leaning and lounging about. Impervious to vandalism and resistant to all weather influences, this table assures you of years of gaming and seating pleasure. You will receive the set of pawns with dice, checkers and chess pieces for free.

Game table in different variants

The anthracite colour exudes class, in combination with the unique HeBlad appearance. A robust, weather-resistant table. This colour does not suit every environment or you may prefer a more natural, lighter version. The multi games table (1-3-2) standard is made of natural concrete. With exactly the same dimensions and specifications, you can also use both tables perfectly as a regular picnic set, in addition to playing games.

Multi games table, picnic set or ping pong table

In addition to the standard version of the multi-game table in natural or anthracite concrete, you can also opt for extra seating comfort. The multi-game table (1-3-2) DeLuxe from HeBlad is equipped with bamboo seating. This is slightly softer on the buttocks than the original concrete and still suitable for any and all weather conditions. All variants of the multi-game table are made from the base of a

3 April 2025 - Prices subject to change

Our products are delivered from our factory in the Netherlands.



correspondence address

HeBlad - UK

The Balance, 7th floor, Pinfold Street
S1 2GU Sheffield, South Yorkshire
T. 0114 352 0110
info@HeBlad.co.uk
www.HeBlad.co.uk

head office address

HeBlad BV

Diamantweg 22
NL - 5527 LC Hapert

HeBlad picnic set. If you would like seating on your property, but are not necessarily looking for a games table, you can also choose from a wide range of our picnic sets and concrete benches. These are all perfect combinations with our concrete ping pong tables!

Contact HeBlad

HeBlad is well known for its concrete ping pong tables. Because we make all products ourselves and in our own factory, you are assured of fast delivery. It is good to always check the delivery conditions in advance, so that you and we are not faced with any surprises. If in doubt, always contact us. We are happy to help!

*1 set is included for free per game (chess pieces, checkers and pawns)

Our products are delivered from our factory in the Netherlands.

Registered under: HeBlad BV • HM Revenue and Customs • Ruby House 8 • Ruby Place • AB10 1ZP Aberdeen
VAT Number GB381060225 • EORI Number GB381060225000 • Commercial register (NL) 170 66 364
Rabobank De Kempen, Markt 7, 5531 BA Bladel (NL) • BIC RABONL2U • Branch code RABONL2UXXX • IBAN NL 20 RABO 0107530112 GBP

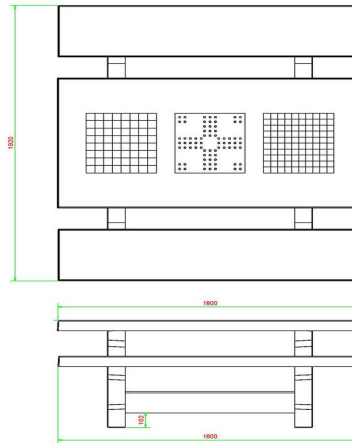
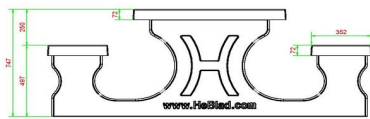

HeBlad
www.HeBlad.com
PS.STAB.GT.132
± 950 KG.

Specifications Multi Gaming table (1-3-2) Standard Anthracite-Concrete

Product code	PS.STAB.GT.132	Tabletop thickness	7 cm
Colour	Anthracite concrete	Seat height	50 cm
Dimensions (L x W x H)	210 x 193 x 75 cm	Weight	950 kg
Dimensions tabletop (L x W)	210 x 90 cm	Material seat	Beton
Height tabletop	75 cm	Distance legs	111 cm (center to center)

Related products



PS.STAB.GT.111



PS.DL.GT.132

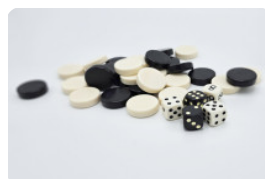

GT.BG.pieces



GT.CK.Pieces



GT.CH.Pieces

Our products are delivered from our factory in the Netherlands.



Multi Gaming table (1-3-2) DeLuxe

Product code: PS.DL.GT.132

£ 4,150.00 excl. VAT
(£ 4,980.00 incl. VAT)

In this digital age, far too much of our time is taken up by looking at a screen. Fortunately, we've got the Multi-Game Table Deluxe with which you can draw people away from their screens and invite them to play old-fashioned games together. This table is made of concrete, has two benches to sit on and three integrated games. Of course you will also receive the appropriate playing pieces with the table. It is an ideal benefit for any public space, (school) yard, park, snack bar or café.

The games table and the games

The Multi-Game Table Deluxe is equipped with three games. You will find Ludo in the middle and on either side of which a checkers game and a chess game can be found. A set of pawns and pieces is supplied standardly, so you can immediately take place and start playing. The games are integrated into the table top and therefore cannot be blown away or stolen. The pieces and pawns are separate from the table and must be neatly put away when you have finished playing. The table is made from one piece of gray concrete and has two bamboo benches.

Variants of games table

Other versions of this Multi-Game Table are also available. Perhaps you prefer anthracite concrete, a colour that is currently very popular. You may also wish to arrange the games in a different order. In this case, you may want to take a look at the variants of the Deluxe Game table with Chess (1), Ludo (3), Checkers (2). You can also contact us and let us know your wishes. We'll then make a beautiful table that meets your standards exactly.

3 April 2025 - Prices subject to change

Our products are delivered from our factory in the Netherlands.



correspondence address

HeBlad - UK

The Balance, 7th floor, Pinfold Street
S1 2GU Sheffield, South Yorkshire
T. 0114 352 0110
info@HeBlad.co.uk
www.HeBlad.co.uk

head office address

HeBlad BV

Diamantweg 22
NL - 5527 LC Hapert

High quality

Our Multi-Game Tables are delivered on average within 10 days. This may vary in instances of international delivery. Always contact us if you have any questions, or regard our terms and conditions for delivery.

When you have the table installed (this is a service we provide for you), you can finally start to enjoy your multigame table. Such a table will serve you for many years to come, as it is made of high-quality material and is impossible to steal.

Explanation of the codes:

- 1 = Chess game
- 2 = Checkers game
- 3 = Ludo game

1 set is included per game (chess pieces, checkers and Ludo pawns)

The games table is also available in anthracite concrete. At the games table you can choose which game sheet you want to have collapsed in which place. Would you prefer a different layout? Please contact us.

Our products are delivered from our factory in the Netherlands.

Registered under: HeBlad BV • HM Revenue and Customs • Ruby House 8 • Ruby Place • AB10 1ZP Aberdeen
VAT Number GB381060225 • EORI Number GB381060225000 • Commercial register (NL) 170 66 364

Rabobank De Kempen, Markt 7, 5531 BA Bladel (NL) • BIC RABONL2U • Branch code RABONL2UXXX • IBAN NL 20 RABO 0107530112 GBP

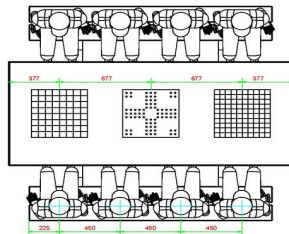
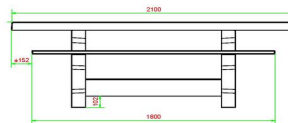
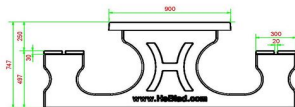
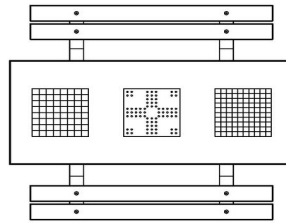
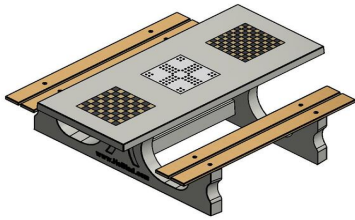

HeBlad
www.HeBlad.com
PS.DL.GT.132
± 780 KG.

Specifications Multi Gaming table (1-3-2) DeLuxe

Product code	PS.DL.GT.132	Height tabletop	75 cm
Colour	Natural concrete	Seat height	50 cm
Dimensions (L x W x H)	210 x 193 x 75 cm	Material seat	Bamboo
Dimensions tabletop (L x W)	210 x 90 cm	Distance legs	111 cm (center to center)
Tabletop thickness	7 cm	Weight	780 kg

Related products



PS.DLAB.GT.132



PS.ST.GT.132



GT.CH.Pieces

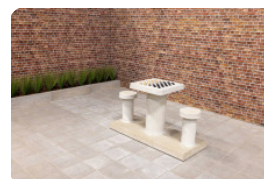

GT.CK.2



GT.CK.Pieces

Our products are delivered from our factory in the Netherlands.



Multi Gaming table (1-3-2) DeLuxe Anthracite-Concrete

Product code: PS.DLAB.GT.132

Multi and DeLuxe, that can only bode well. Which games are included in the Multi games table? In this Multi games table, Multi stands for three different games, namely a chess game, a ludo game (pawn game) and a checkers game. In the standard version of this games table, the ludo game is placed in the middle of the table top, the chess and checkers game at the ends of the games table. If you prefer a different layout of the game table, please contact us and we will ensure that the games are deposited into the table top in your desired order.

What does DeLuxe mean? At HeBlad, DeLuxe means that the seats are made of bamboo instead of concrete. A comfortable solution for a softer seat. Just like concrete, bamboo is weather resistant and ideal for the outdoors and intensive use.

What variants does the Multi games table have?

In addition to the Multi games table anthracite concrete, you also have the option to choose the Multi games table natural concrete DeLuxe. The same games are integrated into the table top, the seats are also made of bamboo and the material is also sturdy concrete. Only the colour is different. Of course you can also combine both tables for a beautiful colourful addition to your area.

Do you prefer a smaller table, but do you still want a games table? At HeBlad we have provided you with a wide range to choose from. How about the chess table, ludo table or checkers table as a separate product? These tables are available in two or four-person versions and in the colours natural concrete and anthracite concrete.

Contact us or order online

HeBlad stands for quality, which also includes good service. Service from the very

3 April 2025 - Prices subject to change

Our products are delivered from our factory in the Netherlands.



correspondence address

HeBlad - UK

The Balance, 7th floor, Pinfold Street
S1 2GU Sheffield, South Yorkshire
T. 0114 352 0110
info@HeBlad.co.uk
www.HeBlad.co.uk

head office address

HeBlad BV

Diamantweg 22
NL - 5527 LC Hapert

first moment of contact. All your questions, ideas and comments are welcome.
We think along with you, measure if necessary, provide advice if you wish and will
do everything we can to make you a satisfied HeBlad customer.

Our products are delivered from our factory in the Netherlands.

Registered under: HeBlad BV • HM Revenue and Customs • Ruby House 8 • Ruby Place • AB10 1ZP Aberdeen
VAT Number GB381060225 • EORI Number GB381060225000 • Commercial register (NL) 170 66 364
Rabobank De Kempen, Markt 7, 5531 BA Bladel (NL) • BIC RABONL2U • Branch code RABONL2UXXX • IBAN NL 20 RABO 0107530112 GBP

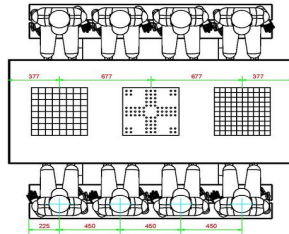
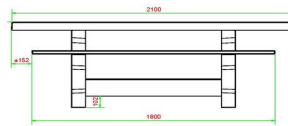
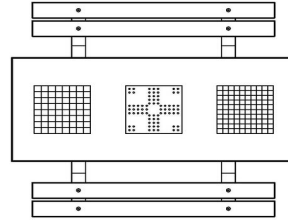
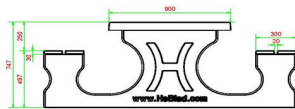
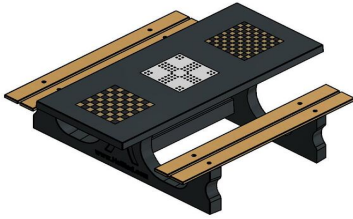

HeBlad
www.HeBlad.com
PS.DLAB.GT.132
± 780 KG.

Specifications Multi Gaming table (1-3-2) DeLuxe Anthracite-Concrete

Product code	PS.DLAB.GT.132	Height tabletop	75 cm
Colour	Anthracite concrete	Seat height	50 cm
Dimensions (L x W x H)	210 x 193 x 75 cm	Material seat	Bamboo
Dimensions tabletop (L x W)	210 x 90 cm	Distance legs	111 cm (center to center)
Tabletop thickness	7 cm	Weight	780 kg

Related products



PS.DL.GT.132



BB.CH.AB



GT.CK.Pieces

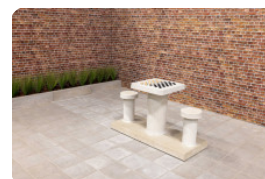

GT.CK.2



OP.PS.AB.246

Our products are delivered from our factory in the Netherlands.



Concrete Foot Volleyball Table Green

Product code: VV.GR

£ 4,000.00 excl. VAT
(£ 4,800.00 incl. VAT)

Are you looking for a game table for an active game? Then choose our green concrete foot volleyball table. This table resembles the table used for table tennis, only it is slightly curved. Just like our table tennis tables, this product is cast from one piece of concrete. The net is available in the center of the table in the form of a raised edge. This table can be used to play all kinds of games, but in most cases foot volleyball (Teqball) is played on it. This table is an ideal asset for football clubs, schools, playgrounds and public parks.

What is foot volleyball or Teqball? Foot volleyball is a ball sport similar to table tennis, but is played on a curved table with a ball similar to a soccer ball, and the players can play the ball with any part of the body except the hands.

What are the specifications of the concrete foot volleyball table green?

As you have come to expect from HeBlad, we supply products of the best quality. Our foot volleyball tables/Teqball tables are no exception and this is reflected in the specifications.

- Cast from one piece of concrete for optimal strength.
- Ideal for outdoor use and resistant to all weather conditions.
- Dimensions: 274 x 152 x 8.4 centimeters.
- Can be used for various games.
- Painted green to resemble a table tennis table.

Can the foot volleyball table be placed outside?

3 April 2025 - Prices subject to change

Our products are delivered from our factory in the Netherlands.

This concrete foot volleyball table is specifically designed for outdoor use. Of course, you will need some space for the table and the playing field around it. You can play all kinds of games on it, but foot volleyball or Teqball are the most common. That is why it is an ideal product for the (school) yard, the sports club, the park, the campsite and the playground. Besides providing everyone with an enjoyable game, it is also an ideal way to improve football technique. This way you can kill two birds with one stone!

How much space is needed for a foot volleyball table? We recommend placing the foot volleyball table in an obstacle-free space of 10 x 8 meters. Agile football players often need a smaller free space. Combine this game table with one of our benches or other game tables for extra fun!

What is the delivery time of the foot volleyball table?

The delivery time for this table is an average of six weeks. This means that you can soon play a game of foot volleyball at our concrete volleyball table. Easily order online or inquire about the options and delivery conditions. If you have any further questions, please do not hesitate to contact us. We are happy to help you!

**When you purchase a HeBlad foot volleyball table, a football is included for free.

Our products are delivered from our factory in the Netherlands.

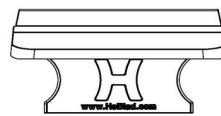
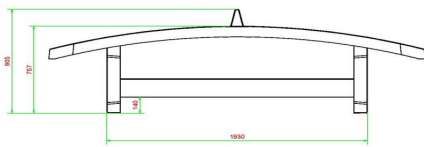
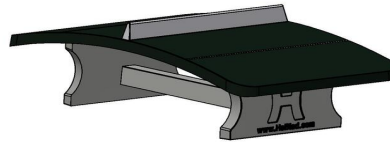
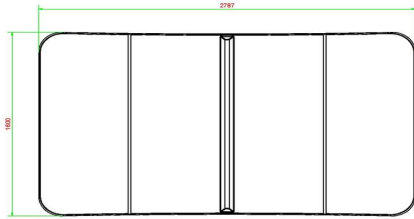

HeBlad
www.HeBlad.com
VV.GR
±1385 KG

Specifications Concrete Foot Volleyball Table Green

Product code	VV.GR	Height tabletop	76 cm
Colour	Green - RAL 6009	Height of the net	14,75 cm
Dimension playing surface (L x W)	274 x 152 cm	Weight	1385 kg
Dimensions bottom of playing surface	278 x 156 cm	Distance legs	183 cm (center to center)
Tabletop thickness	8,4 cm		

Related products



VV.AB



VV.NT



PP.AR.AB



PP.BL



PP.R.GR

Our products are delivered from our factory in the Netherlands.



Concrete Foot Volleyball Table Blue

Product code: VV.BL

£ 4,000.00 excl. VAT
(£ 4,800.00 incl. VAT)

A beautiful sleek lacquered foot volleyball table as the centerpiece of the schoolyard, park, campsite or club site. That invites people to move, both the younger and older generations. Because this foot volleyball table is curved, numerous game variations can be played.

How is foot volleyball, or Teqball, played? Foot volleyball/Teqball is a fun and effective way to improve football skills, among other things. It is a ball sport, and the game is comparable to table tennis. Teqball however, is played on a curved table with a ball similar to a football, and the players can hit the ball with any part of the body except the hands. Working on technique, coordination, fitness, ball control and concentration all the while playing a fun game. Choose the colour that suits you and play a challenging and active game together.

What makes HeBlad's gaming tables so strong?

Our foot volleyball tables, just like our table tennis tables and other game and gaming tables, are made of concrete and cast in one piece. The tables are very suitable for outdoor use, specially made to withstand all weather conditions. The blue lacquer makes the table a pleasure to the eye and easy to maintain. The table top is slightly curved and has the dimensions 274 x 152 cm. An inviting, solid eye-catcher on your property with a guarantee of years of fun.

Delivery foot volleyball table

Because HeBlad's gaming tables are made and transported in our own factory,

3 April 2025 - Prices subject to change

Our products are delivered from our factory in the Netherlands.



correspondence address

HeBlad - UK

The Balance, 7th floor, Pinfold Street
S1 2GU Sheffield, South Yorkshire
T. 0114 352 0110
info@HeBlad.co.uk
www.HeBlad.co.uk

head office address

HeBlad BV

Diamantweg 22
NL - 5527 LC Hapert

fast delivery is guaranteed. We always deliver within six working weeks. So when you decide to order this fantastic, blue foot volleyball table, it will be installed very quickly. To plan an installation, please do consider our terms and conditions of delivery.

Questions about our foot volleyball table?

If you have any questions about this foot volleyball table, the materials we use, our other game tables or the terms of delivery, please contact us. We are happy to assist you by telephone or e-mail. Together we'll discuss your wishes and options. Our team of professionals is ready to assist you.

Because this blue foot volleyball table can very well be combined with other HeBlad game tables, picnic tables, benches or a ping pong table, we would like to show you the possibilities that HeBlad offers you. Please feel free to take a look at our other products.

**When you purchase a HeBlad foot volleyball table, a football is included for free.

We recommend placing the foot volleyball table in an obstacle-free space of 10 x 8 meters. Agile football players often need a smaller free space.

Our products are delivered from our factory in the Netherlands.

Registered under: HeBlad BV • HM Revenue and Customs • Ruby House 8 • Ruby Place • AB10 1ZP Aberdeen
VAT Number GB381060225 • EORI Number GB381060225000 • Commercial register (NL) 170 66 364
Rabobank De Kempen, Markt 7, 5531 BA Bladel (NL) • BIC RABONL2U • Branch code RABONL2UXXX • IBAN NL 20 RABO 0107530112 GBP

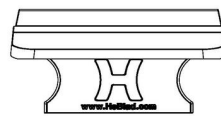
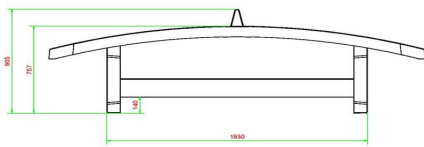
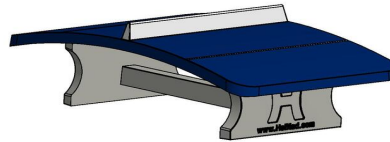
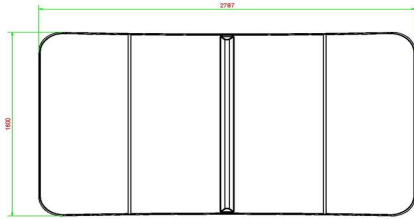

HeBlad
www.HeBlad.com
VV.BL
±1385 KG

Specifications Concrete Foot Volleyball Table Blue

Product code	VV.BL	Height tabletop	76 cm
Colour	Blue - RAL 5005	Height of the net	14,75 cm
Dimension playing surface (L x W)	274 x 152 cm	Weight	1385 kg
Dimensions bottom of playing surface	278 x 156 cm	Distance legs	183 cm (center to center)
Tabletop thickness	8,4 cm		

Related products



VV.AB



VV.GR



PP.AR.GR



PP.AB



PP.R.BL

Our products are delivered from our factory in the Netherlands.



Concrete Foot Volleyball Table Anthracite

Product code: VV.A

£ 4,000.00 excl. VAT
(£ 4,800.00 incl. VAT)

Foot volleyball played on a gaming table is also known as Teqball. Where does this game come from? In 2014, a Hungarian footballer introduced it. A combination of table tennis and football. This game is a sport where players use their shoulders, head, chest, legs and feet to get the ball to the other side of the game table. A game fit to train technique and skills.

What is a foot volleyball table?

To play the sport Teqball you need a game table. It is a table that is curved and resembles a ping-pong table. The HeBlad foot volleyball tables are made from a single piece of robust concrete and have exactly the specifications that guarantee that the Teqball game can be played well. The table will provide years of fun and will remain in perfect condition regardless of the weather conditions the table experiences.

Specifications of the anthracite foot volleyball table

What are the features of the anthracite foot volleyball table from HeBlad? All HeBlad products radiate solidity and beauty. The robust concrete is of high quality and resistant to vandalism. The foot volleyball table guarantees for decades of use, without losing its beautiful appearance and functional aspect. The base and net of this anthracite version are made of natural concrete. The table top is painted with anthracite lacquer. This all makes the table weather resistant and easy to maintain.

Which variants does the anthracite foot volleyball table have?

The foot volleyball table is available in the colours green, blue, anthracite, natural concrete and anthracite concrete. All variants have the same weight, the same

3 April 2025 - Prices subject to change

Our products are delivered from our factory in the Netherlands.



correspondence address

HeBlad - UK

The Balance, 7th floor, Pinfold Street
S1 2GU Sheffield, South Yorkshire
T. 0114 352 0110
info@HeBlad.co.uk
www.HeBlad.co.uk

head office address

HeBlad BV

Diamantweg 22
NL - 5527 LC Hapert

dimensions and are made of rock-solid concrete, cast in one piece. The foot volleyball table is ideal to combine with other concrete products from HeBlad. Match a concrete picnic set in the same colour or a checker bench in a contrasting colour. Discover the endless possibilities to vary combinations, and explore all of the options we have to offer you.

If you have questions about the space required to install HeBlad products, please feel free to contact us. Our team of professionals knows how to help you best.

**When you purchase a HeBlad foot volleyball table, you will receive a free football. The base plate is not supplied as standard and is not included in the price.

Our products are delivered from our factory in the Netherlands.

Registered under: HeBlad BV • HM Revenue and Customs • Ruby House 8 • Ruby Place • AB10 1ZP Aberdeen
VAT Number GB381060225 • EORI Number GB381060225000 • Commercial register (NL) 170 66 364
Rabobank De Kempen, Markt 7, 5531 BA Bladel (NL) • BIC RABONL2U • Branch code RABONL2UXXX • IBAN NL 20 RABO 0107530112 GBP

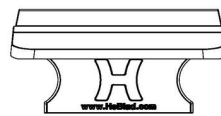
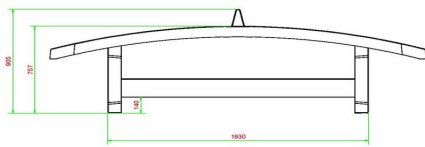
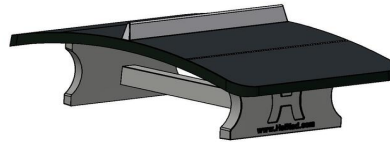
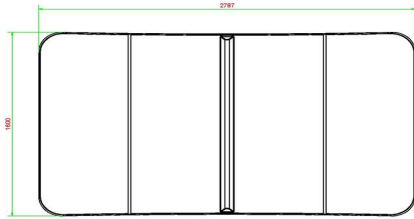

HeBlad
www.HeBlad.com
V.V.A
±1385 KG

Specifications Concrete Foot Volleyball Table Anthracite

Product code	VV.A	Height tabletop	76 cm
Colour	Anthracite - RAL 7016	Height of the net	14,75 cm
Dimension playing surface (L x W)	274 x 152 cm	Weight	1385 kg
Dimensions bottom of playing surface	278 x 156 cm	Distance legs	183 cm (center to center)
Tabletop thickness	8,4 cm		

Related products



VV.GR



HB.Paint-7016



OP.PS



OP.PS.AB

Our products are delivered from our factory in the Netherlands.



Foot Volleyball Table Natural Concrete

Product code: VV.NT

£ 3,950.00 excl. VAT
(£ 4,740.00 incl. VAT)

You can play all kinds of games with a concrete foot volleyball table. Often a football is used and a game such as table tennis is played. The table is curved and has a raised edge in the middle, like a net on a table tennis table. Our foot volleyball tables are of high quality and cast from one piece of concrete. It is ideal in the garden, on the square, at the sports club or in the park, because everyone can play a game on it. Naturally, they are resistant to all weather conditions and are strong enough to be used for many years. This foot volleyball table is made of Natural Concrete, but also available in Anthracite Concrete, and other colours.

The specifications of the concrete foot volleyball table
Our foot volleyball tables are made to last. This can be seen from the specifications:

- Cast from one piece of concrete for optimal strength.
- Resistant to all weather influences.
- Made in natural concrete, but anthracite concrete and other colours are also available.
- Dimensions 274 x 152 x 8.4 centimeters.
- Ideal for playing the latest craze of football volleyball.

For fun and better technique

Our concrete foot volleyball table can be used in all kinds of situations. Because it is large and requires space to play, the best place is outside. You can place this table in your own garden, but also in public places such as squares, at schools, in

3 April 2025 - Prices subject to change

Our products are delivered from our factory in the Netherlands.



correspondence address

HeBlad - UK

The Balance, 7th floor, Pinfold Street
S1 2GU Sheffield, South Yorkshire
T. 0114 352 0110
info@HeBlad.co.uk
www.HeBlad.co.uk

head office address

HeBlad BV

Diamantweg 22
NL - 5527 LC Hapert

the park, at the sports club or in the playground. It is an excellent way to improve technique with the ball, so if you have a football club you can kill two birds with one stone. Players can improve their ball control and enjoy a versatile game.

Delivered quickly

If you decide to purchase one of our foot volleyball tables, the delivery time is an average of six weeks to the UK. This means that you can soon benefit from all the advantages of our concrete foot volleyball table. Why not start with a game of foot volleyball? The players must pass a football through one bounce on the table, similar to the way the ball is passed in table tennis. Only they don't use a bat for this, but any body part apart from the hands.

When ordering one of our products, please advise our terms and conditions for delivery. In case you have any further questions, please don't hesitate to contact us. Our professionals will happily answer any questions you may have.

****When you purchase a HeBlad foot volleyball table, a football is included for free.**

We recommend placing the foot volleyball table in an obstacle-free space of 10 x 8 meters.

Agile football players often need a smaller free space.

Our products are delivered from our factory in the Netherlands.

Registered under: HeBlad BV • HM Revenue and Customs • Ruby House 8 • Ruby Place • AB10 1ZP Aberdeen
VAT Number GB381060225 • EORI Number GB381060225000 • Commercial register (NL) 170 66 364

Rabobank De Kempen, Markt 7, 5531 BA Bladel (NL) • BIC RABONL2U • Branch code RABONL2UXXX • IBAN NL 20 RABO 0107530112 GBP

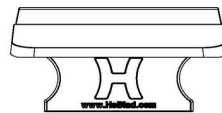
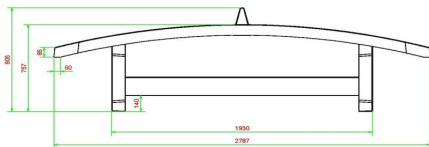
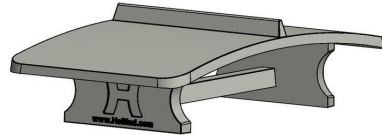
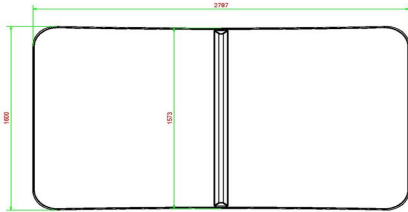

HeBlad
www.HeBlad.com
VV.NT
±1385 KG

Specifications Foot Volleyball Table Natural Concrete

Product code	VV.NT	Height tabletop	76 cm
Colour	Natural concrete	Height of the net	14,75 cm
Dimension playing surface (L x W)	274 x 152 cm	Weight	1385 kg
Dimensions bottom of playing surface	278 x 156 cm	Distance legs	183 cm (center to center)
Tabletop thickness	8,4 cm		

Related products



VV.AB



PP.GR



PP.AR.BL



BB.CH.AB



PP.R.NT

Our products are delivered from our factory in the Netherlands.



Foot Volleyball Table Anthracite-Concrete

Product code: VV.AB

£ 4,100.00 excl. VAT
(£ 4,920.00 incl. VAT)

A foot volleyball table is a true showpiece on a schoolyard, in parks, playgrounds and at sports clubs. A foot volleyball table is a gaming table that resembles a table tennis table and on which all kinds of game variations can be played with a football. This table guarantees a lot of fun for both young and old.

Playing on the foot volleyball table

On the foot volleyball table you can play the new sport of foot volleyball, a game similar to table tennis. A table tennis table is flat, completely straight. A foot volleyball table is slightly curved. And the ball being played with is a larger ball than a ping pong ball, namely a football. No bats are used in this game, players must play the ball using any part of their body, apart from their hands.

Quality of the foot volleyball table

Just like our other products, this foot volleyball table is made from a single piece of concrete. We use very high quality concrete for all HeBlad products. This means that we guarantee that you will enjoy your foot volleyball table for years to come. In addition, this foot volleyball table, like all other HeBlad products, is resistant to all weather influences.

Different variants

HeBlad offers the foot volleyball tables in 5 different colours. This foot volleyball table is supplied as standard in the colour anthracite concrete, but we also offer the colour natural concrete, lacquered green, lacquered anthracite and lacquered

3 April 2025 - Prices subject to change

Our products are delivered from our factory in the Netherlands.



correspondence address

HeBlad - UK
The Balance, 7th floor, Pinfold Street
S1 2GU Sheffield, South Yorkshire
T. 0114 352 0110
info@HeBlad.co.uk
www.HeBlad.co.uk

head office address

HeBlad BV
Diamantweg 22
NL - 5527 LC Hapert

blue.

Combining the foot volleyball table

You can easily combine the foot volleyball table with, for example, a concrete bench or a concrete picnic table. This way you encourage young people, but also the elderly, to spend more time outdoors together.

Interested in the foot volleyball table?

Are you interested in the foot volleyball table that HeBlad offers? Then easily order a foot volleyball table on our website. Do you have any questions about the foot volleyball table or another product? Please view our frequently asked questions page or feel free to contact us. We are happy to help you with your question!

Football volleyball is a ball sport similar to table tennis, but is played on a curved table with a ball similar to a soccer ball, and the players can hit the ball through any part of the body except the hands.

****When you purchase a HeBlad foot volleyball table, a football is included for free.**

We recommend placing the foot volleyball table in an obstacle-free space of 10 x 8 meters.

Agile football players often need a smaller free space.

Our products are delivered from our factory in the Netherlands.

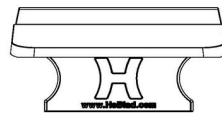
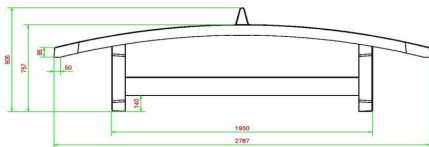
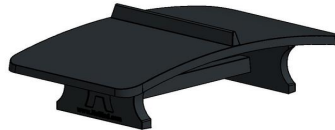
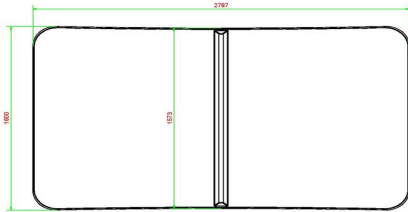

HeBlad
www.HeBlad.com
VV.AB
±1385 KG

Specifications Foot Volleyball Table Anthracite-Concrete

Product code	VV.AB	Height tabletop	76 cm
Colour	Anthracite concrete	Height of the net	14,75 cm
Dimension playing surface (L x W)	274 x 152 cm	Weight	1385 kg
Dimensions bottom of playing surface	278 x 156 cm	Distance legs	183 cm (center to center)
Tabletop thickness	8,4 cm		

Related products



PP.AR.BL



PP.R.NT



PP.GR



BB.CH.AB



PP.AR.AB

Our products are delivered from our factory in the Netherlands.



Bench Standard Natural Concrete

Product code: BB.ST

£ 1,650.00 excl. VAT
(£ 1,980.00 incl. VAT)

Our concrete bench is made of a single piece of concrete and weighs 800 kilos. It is an ideal bench for your garden or at your company, because it gives people a place to sit, rest, have something to eat and drink and have a chat. But because it is, in simple terms, a block of concrete, it can also serve as a boundary fence. We even have customers who have placed our concrete benches around their facility to prevent a ram raid. This way they get peace of mind and offer their customers and bystanders a place to sit. That's two birds with one stone.

Various applications of concrete bench

Our concrete benches can be placed in all kinds of places. Of course you can place it in your garden and combine it with our ping pong table or football table. You can also do this if you have a terrace or if you want to give visitors to your establishment the option of sitting outside. Other ideal places for these concrete benches are in the park, on the schoolyard or on the market. Because they are made in one piece, they cannot be taken apart and because they weigh 600 kilos, they are not exactly easy to steal. Once you have installed this concrete bench, you can be sure that you and everyone who visits you will enjoy using it for many years to come.

Concrete bench features

Our concrete benches have a simple design and can be supplied with or without a base plate. Because they are made of high-quality C45/55 concrete with a high compressive strength, they are almost indestructible. The dimensions of the seat are 175 by 30 centimeters, which means that you can easily seat four people.

3 April 2025 - Prices subject to change

Our products are delivered from our factory in the Netherlands.



correspondence address

HeBlad - UK

The Balance, 7th floor, Pinfold Street
S1 2GU Sheffield, South Yorkshire
T. 0114 352 0110
info@HeBlad.co.uk
www.HeBlad.co.uk

head office address

HeBlad BV

Diamantweg 22
NL - 5527 LC Hapert

Because the bench is almost 50 centimeters t,all everyone can sit comfortably on it. We also supply concrete benches with a round shape and a bamboo seat, if you are interested. These concrete benches not only invite you to take a step back, they are also ideal if you want to protect your site.

Our products are delivered from our factory in the Netherlands.

Registered under: HeBlad BV • HM Revenue and Customs • Ruby House 8 • Ruby Place • AB10 1ZP Aberdeen
VAT Number GB381060225 • EORI Number GB381060225000 • Commercial register (NL) 170 66 364
Rabobank De Kempen, Markt 7, 5531 BA Bladel (NL) • BIC RABONL2U • Branch code RABONL2UXXX • IBAN NL 20 RABO 0107530112 GBP

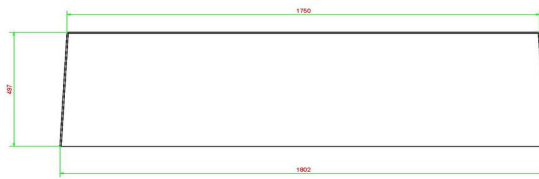
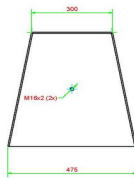
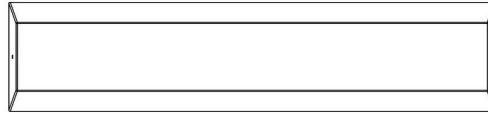
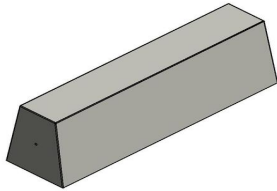

HeBlad
www.HeBlad.nl
BB.ST
Gewicht ± 800 KG

Specifications Bench Standard Natural Concrete

Product code	BB.ST	Seat height	47,5 cm
Colour	Natural concrete	Material seat	Beton
Dimensions (L x W x H)	180 x 50 x 47,5 cm	Number of seats	4
Dimensions seat	175 x 30 cm	Weight	800 kg

Related products



BB.DL.OV



PS.ST



PP.AR.BL



HB.FB.A



OP.BB

Our products are delivered from our factory in the Netherlands.



Concrete Bench Standard Anthracite

Product code: BB.ST.A

£ 1,700.00 excl. VAT
(£ 2,040.00 incl. VAT)

With a seat height of 50 cm and a seating surface of 175 x 30 cm, it is wonderful to sit on this concrete bench, standard in anthracite version. Just like the shape of this concrete bench is, the anthracite lacquer layer is really sleek. A true addition to your site, in the park or on the schoolyard.

Place the concrete bench near game tables and ping pong tables

Due to its sleek shape and smooth paint, this concrete bench in anthracite version can be perfectly combined with other HeBlad gaming tables. For example, place the concrete bench near a ping-pong table and you are guaranteed an audience. While a number of people enjoy a game of table football, others can rest or watch from the concrete bench.

Because HeBlad's ping pong tables, like the benches, are made from a single piece of concrete, you never have to worry about weathered attributes on your site. All our products are easy to maintain and resistant to all weather influences.

Also use a concrete bench as a blockade and security

This 600 kg concrete bench is ideal as a blockade or for security. It is not inviting to break in when a blockade of robust concrete has been erected. Another use of our concrete bench is as a road blockage.

In addition to a nice seating area, you also give yourself and the users safety by placing this concrete bench. Because the concrete bench does not need to be anchored, the bench is immediately ready for use.

About HeBlad

3 April 2025 - Prices subject to change

Our products are delivered from our factory in the Netherlands.



correspondence address

HeBlad - UK

The Balance, 7th floor, Pinfold Street
S1 2GU Sheffield, South Yorkshire
T. 0114 352 0110
info@HeBlad.co.uk
www.HeBlad.co.uk

head office address

HeBlad BV

Diamantweg 22
NL - 5527 LC Hapert

Are you curious about HeBlad products or curious about our working method? Please feel free to contact us, we will be happy to answer all your questions. In order for you to be able to assess us based on the experiences of others, we have placed reviews on the website. Even if you have doubts about the suitability of your site or the space you have available for the standard concrete bench in anthracite version or one of HeBlad's other products, we will help you. For more information about delivery and our conditions, [click here](#).

Our products are delivered from our factory in the Netherlands.

Registered under: HeBlad BV • HM Revenue and Customs • Ruby House 8 • Ruby Place • AB10 1ZP Aberdeen
VAT Number GB381060225 • EORI Number GB381060225000 • Commercial register (NL) 170 66 364
Rabobank De Kempen, Markt 7, 5531 BA Bladel (NL) • BIC RABONL2U • Branch code RABONL2UXXX • IBAN NL 20 RABO 0107530112 GBP

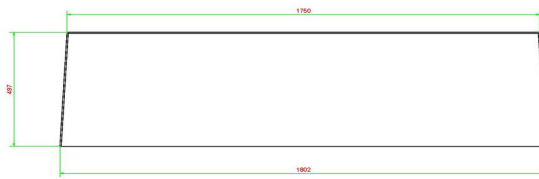
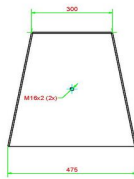
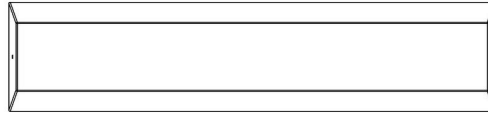
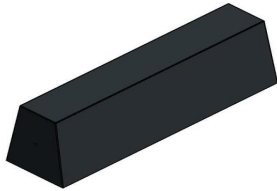

HeBlad
www.HeBlad.com
BB.ST.A
Gewicht ± 800 KG

Specifications Concrete Bench Standard Anthracite

Product code	BB.ST.A	Seat height	50 cm
Colour	Anthracite lacquered, RAL 7016	Material seat	Beton
Dimensions (L x W x H)	180 x 47,5 x 50 cm	Number of seats	4
Dimensions seat	175 x 30 cm	Weight	800 kg

Related products



BB.DL.A



PS.ST.A



PP.AR.GR



HB.FB.A



OP.BB

Our products are delivered from our factory in the Netherlands.



Bench Standard Anthracite-Concrete

Product code: BB.ST.AB

£ 1,725.00 excl. VAT
(£ 2,070.00 incl. VAT)

This concrete bench is ideal for outdoor use due to its simplicity and solidity. Made in one piece and cast from anthracite concrete, this concrete bench is perfect for outdoors. The anthracite colour always remains beautiful, regardless of the weather influences it is exposed to. A beautiful, sturdy and practical piece of jewelry for your garden, square, park or grounds. Thanks to its sleek appearance, this concrete bench is attractive for any environment and can be used multifunctionally.

Anthracite concrete bench is multifunctional

With an ideal seat height of 50 cm, this anthracite concrete bench is a wonderful bench to sit on, even with 4 people at the same time. Because of the surface dimensions of the seat (175 x 30 cm), the sofa can also be used to display attributes.

In addition to the seating option and use as a table, the concrete bench with its 800 kg of strength can also serve perfectly as protection against ram raids or burglary. Or as a partition between different rooms or areas.

Combine concrete bench with concrete game table

The anthracite concrete outdoor bench can be easily combined with other benches and game tables from HeBlad. For example, place several anthracite concrete benches together or alternate with a standard concrete bench in natural concrete. All HeBlad concrete products are designed and manufactured to last a lifetime out of service. When ordering an extra concrete bench for outdoor use, you will receive a 17% discount and delivery is free.

3 April 2025 - Prices subject to change

Our products are delivered from our factory in the Netherlands.



correspondence address

HeBlad - UK

The Balance, 7th floor, Pinfold Street
S1 2GU Sheffield, South Yorkshire
T. 0114 352 0110
info@HeBlad.co.uk
www.HeBlad.co.uk

head office address

HeBlad BV

Diamantweg 22
NL - 5527 LC Hapert

Installation of concrete bench

HeBlad designs, produces and supplies high-quality products in-house. The anthracite concrete bench is placed at the location of your choice, subject to delivery conditions. If the surface on which the bench is to be placed is not or not completely suitable, it is advisable to place the concrete bench on a base plate. This is specially made for more stability and fits perfectly with the bench due to the same colour and material composition.

Get informed and order directly online

Do you have any questions about the concrete bench or other HeBlad products? Please contact us, we have all the expertise to answer your questions. To make it easy for you, you can also order directly online.

Our products are delivered from our factory in the Netherlands.

Registered under: HeBlad BV • HM Revenue and Customs • Ruby House 8 • Ruby Place • AB10 1ZP Aberdeen
VAT Number GB381060225 • EORI Number GB381060225000 • Commercial register (NL) 170 66 364

Rabobank De Kempen, Markt 7, 5531 BA Bladel (NL) • BIC RABONL2U • Branch code RABONL2UXXX • IBAN NL 20 RABO 0107530112 GBP

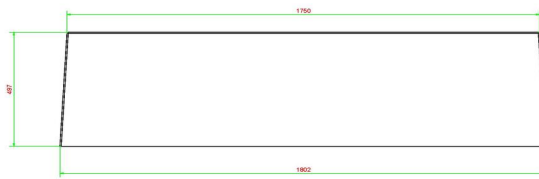
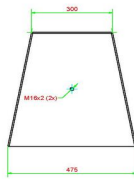
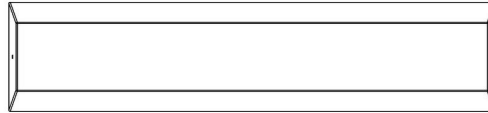
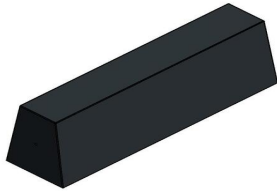

HeBlad
www.HeBlad.com
BB.ST.AB
Gewicht ± 800 KG

Specifications Bench Standard Anthracite-Concrete

Product code	BB.ST.AB	Seat height	50 cm
Colour	Anthracite concrete	Material seat	Beton
Dimensions (L x W x H)	180 x 47,5 x 50 cm	Number of seats	4
Dimensions seat	175 x 30 cm	Weight	800 kg

Related products



BB.DL



BB.DL.A

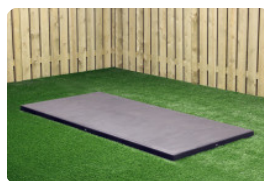

OP.BB.AB

Our products are delivered from our factory in the Netherlands.



Repair Kit table tennis green

Product code: HB.Repair.PP.GR

£ 200.00 excl. VAT
(£ 240.00 incl. VAT)

Although we at HeBlad stand for quality and sustainability, things can sometimes go wrong. That is why we offer a repair kit, so that you can patch up your table tennis table yourself when necessary. This repair kit is suitable for versions in green, but we also offer a respective solution for the versions in blue and anthracite.

Would you like to return your table tennis table?

Did you know that you can also return the table tennis table? This is possible when you purchase a new table tennis table from HeBlad. When the new table tennis table is delivered, we will immediately relieve you of the old one. Want to know more or have questions about the costs? Please contact us, we will be happy to help you.

Repair your table yourself

You will receive instructions with the repair kit. It is advisable to read this and, if necessary, watch the instructional video before you start. Before you start, take care of your own safety: wear the safety goggles and gloves that come with the kit.

3 April 2025 - Prices subject to change

Our products are delivered from our factory in the Netherlands.

Specifications Repair Kit table tennis green

Product code

HB.Repair.PP.GR

head office address

HeBlad BV
Diamantweg 22
NL - 5527 LC Hapert

Related products



HB.Repair.AB



HB.Repair.PP.A



PP.AR.GR



PP.GR



PP.AR.LOW.GR

Our products are delivered from our factory in the Netherlands.



Repair kit ping pong table Blue

Product code: HB.Repair.PP.BL

£ 200.00 excl. VAT
(£ 240.00 incl. VAT)

HeBlad offers a handy Repair Kit with which you can carry out the necessary repairs yourself. This kit is suitable for table tennis tables in blue, but suitable solutions are also available for the green and other anthracite-coloured variants.

Return your table tennis table

HeBlad also offers the option to return your table tennis table when purchasing a new table tennis table. When the new table tennis table is delivered, they will take your old table tennis table with them. If you would like to learn more about this option or have any questions about costs, please feel free to contact us for more information.

Instructions for the repair

If you would like to carry out the repair yourself, you will receive an instruction leaflet with the repair kit. It is wise to read this first and, if necessary, also watch the accompanying instructional video before starting the repair.

If you have any further questions or need assistance, our team is here to assist you. Please contact us for this.

3 April 2025 - Prices subject to change

Our products are delivered from our factory in the Netherlands.

Specifications Repair kit ping pong table Blue

Product code HB.Repair.PP.BL

head office address

HeBlad BV
Diamantweg 22
NL - 5527 LC Hapert

Related products



HB.Repair.AB



HB.Repair.PP.A



PP.AR.BL



PP.BL



PP.AR.LOW.BL

Our products are delivered from our factory in the Netherlands.



Repair Kit ping pong table Anthracite

Product code: HB.Repair.PP.A

£ 200.00 excl. VAT
(£ 240.00 incl. VAT)

That is possible with the Repair Kit. This Repair Kit is suitable for the table tennis table in the colour anthracite. Of course there are also Repair Kits for the blue and green versions. Please check carefully that you are ordering the correct colour.

Follow the instructions

If you are going to refurbish the table tennis table with the Repair Kit, it is advisable to first go through the steps carefully and watch the instructional video. It is advisable to refurbish the table tennis table in a dry and dust-free environment. We have also made an instructional video for moving the table tennis table. It is important that you clean the table thoroughly in advance and let it dry before you start working with the Repair Kit. You can see the next steps in the video and read in the package leaflet.

Return table tennis table

Are you opting for a new table tennis table instead of renovating the table? Then, when delivering the new table tennis table, we can also ensure that the old table tennis table is returned. Then you do not have to move the heavy table yourself. Please contact us for this.

3 April 2025 - Prices subject to change

Our products are delivered from our factory in the Netherlands.

Specifications Repair Kit ping pong table Anthracite

Product code HB.Repair.PP.A

head office address

HeBlad BV
Diamantweg 22
NL - 5527 LC Hapert

Related products



HB.Repair.AB



HB.Repair.PP.BL



PP.AR.A



PP.A



PP.AR.LOW.A

Our products are delivered from our factory in the Netherlands.



Repair kit Anthracite-Concrete

Product code: HB.Repair.AB

£ 25.00 excl. VAT
(£ 30.00 incl. VAT)

3 April 2025 - Prices subject to change

Our products are delivered from our factory in the Netherlands.

Specifications Repair kit Anthracite-Concrete

Product code HB.Repair.AB

head office address

HeBlad BV
Diamantweg 22
NL - 5527 LC Hapert

Related products

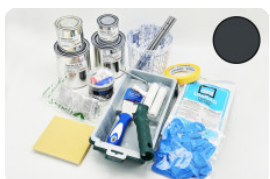

HB.Repair.PP.A



HB.Repair.PP.BL



PP.AR.AB



PP.AB



PP.R.AB

Our products are delivered from our factory in the Netherlands.



Concrete Ping-pong table green, rounded

Product code: PP.AR.GR

£ 2,900.00 excl. VAT
(£ 3,480.00 incl. VAT)

What is a good table tennis table?

Solid concrete and playing safely come together in this variant of our classic ping pong table. By rounding the corners of the ping pong table, we greatly reduce the risk of injuries and bruises. Due to the robust concrete, the corners of the original design sometimes caused discomfort. That discomfort will no longer be an issue with this table tennis table with rounded corners. Younger children can now also safely participate in a game 'around the table'. From what age is playing table tennis allowed, you may ask? This table with rounded corners is safe for any age, but the most ideal age to start playing is starting at six years old, due to the height of the table.

Fun with this table tennis table with rounded corners

A sturdy, strong table tennis table with top and bottom reinforcement. Just like our other tables, this table tennis table with rounded corners cannot be dismantled. The table top, net and legs are cast from one piece of concrete. So: no screws, but solid concrete and a safe product for years of table tennis fun. This green table with rounded corners owes its fresh appearance to the green two-component lacquer with white lacquered lines and the white-coloured net. It is very easy to maintain the fresh look of the table, due to its ease of maintenance and concrete durability. The concrete ping pong tables from HeBlad will give you a lot of table tennis fun for years to come!

Combine concrete table tennis table

3 April 2025 - Prices subject to change

Our products are delivered from our factory in the Netherlands.



correspondence address

HeBlad - UK

The Balance, 7th floor, Pinfold Street
S1 2GU Sheffield, South Yorkshire
T. 0114 352 0110
info@HeBlad.co.uk
www.HeBlad.co.uk

head office address

HeBlad BV

Diamantweg 22
NL - 5527 LC Hapert

This table tennis table provides a lot of fun. Especially when you combine this gaming table with other gaming or gaming tables at your location. How about a bench, or perhaps a picnic set? Do you have the space and would you like to encourage exercise? Then consider adding the HeBlad game tables for foot volleyball or table football to your space. Invest in an active, pleasant outdoor play environment.

Variants of table tennis tables

If you are charmed by this version with rounded corners, but the colour does not quite fit in with the intended environment, take a look at the blue and natural versions. Do you lean more towards other shapes? That's possible! In addition to the rounded corners, we also have the classic version without rounded corners and even an elegant round version. In all cases, you choose a sustainable product with HeBlad products. Please feel free to contact us for any questions about our products!

** When purchasing a HeBlad ping pong table, a set of bats (4 bats and 2 balls) is included for free.

Our products are delivered from our factory in the Netherlands.

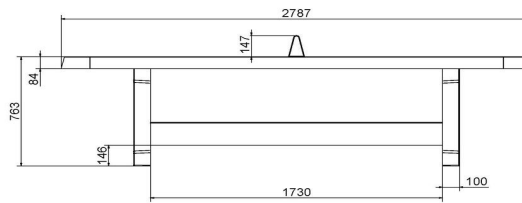
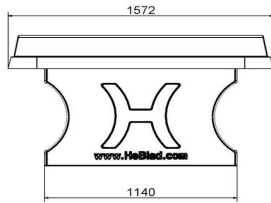
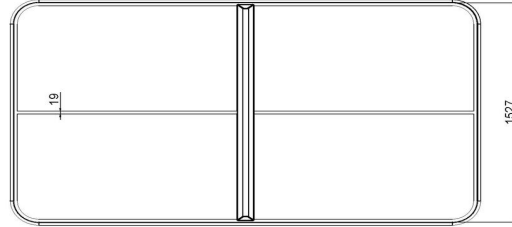
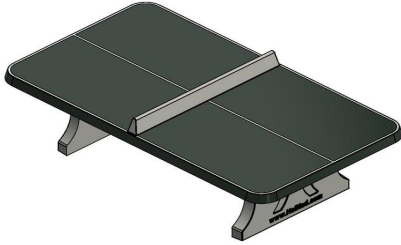

HeBlad
www.HeBlad.com
PP.AR.GR
Gewicht ± 1360 KG

Specifications Concrete Ping-pong table green, rounded

Product code	PP.AR.GR	Height tabletop	76 cm
Colour	Green - RAL 6009	Height of the net	14,75 cm
Dimension playing surface (L x W)	274 x 152 cm	Weight	1360 kg
Dimensions bottom of playing surface	279 x 157 cm	Distance legs	183 cm (center to center)
Tabletop thickness	8,4 cm		

Related products



PP.BL



PP.R.NT



B.DS10



OP.PP



B.DS.SP

Our products are delivered from our factory in the Netherlands.



Blue table tennis table, rounded

Product code: PP.AR.BL

£ 2,900.00 excl. VAT
(£ 3,480.00 incl. VAT)

This ping pong table with rounded corners provides a lot of fun for many different people. This table is ideal for a playground where many children are playing. Rounding the corners of the table reduces the chance of a bruise from a corner. This concrete table tennis table is a nice and popular addition to our range of designs.

Table tennis from what age

The rounded corners of the table top provide more safety when playing around this table tennis table. That is why younger children from the age of 6 can also safely play a game at this table. Due to its shape, this version is perfect for the well-known game 'around the table', where participants have to walk around the table and pass the ball to one another. A challenging and speedy game. At Heblad, the safety of users comes first. In addition to its user-friendliness, the rounded corners also add to the appearance of the table, making it more elegant than the standard design.

How to install a table tennis table

Would you like to place the concrete table tennis table from HeBlad on grass? Then our concrete base plate is a good addition to ensure the stability of the table. If a concrete table tennis table is placed on grass without a base plate, mowing the grass around this table will often prove difficult. The bottom plate also prevents unwanted weeds from growing under the table. The biggest advantage, however, is that the concrete plate provides a maintenance-friendly, stable play area. The concrete base plate is available in combination with all our concrete

3 April 2025 - Prices subject to change

Our products are delivered from our factory in the Netherlands.



correspondence address

HeBlad - UK

The Balance, 7th floor, Pinfold Street
S1 2GU Sheffield, South Yorkshire
T. 0114 352 0110
info@HeBlad.co.uk
www.HeBlad.co.uk

head office address

HeBlad BV

Diamantweg 22
NL - 5527 LC Hapert

table tennis tables.

Where can you find our table tennis tables?

Our game and gaming tables can now be found throughout Europe and even beyond. Schoolyards, campsites and playgrounds are ideal places for the tables. Due to their solidity, our tables do not invite vandalism and can be enjoyed for years to come. Our ping pong tables are available in 5 colours, namely blue, anthracite, green, anthracite concrete and natural. And in the shapes rectangular, rectangular with rounded corners and round.

Do you have any questions about our table tennis tables or other products? Please feel free to contact us. We are happy to give you advice.

** When purchasing a Heblad ping pong table, a set of bats (4 bats and 2 balls) is included for free.

Our products are delivered from our factory in the Netherlands.

Registered under: HeBlad BV • HM Revenue and Customs • Ruby House 8 • Ruby Place • AB10 1ZP Aberdeen
VAT Number GB381060225 • EORI Number GB381060225000 • Commercial register (NL) 170 66 364
Rabobank De Kempen, Markt 7, 5531 BA Bladel (NL) • BIC RABONL2U • Branch code RABONL2UXXX • IBAN NL 20 RABO 0107530112 GBP

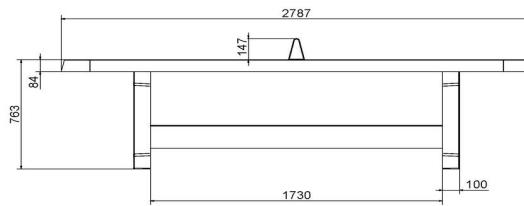
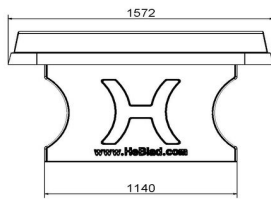
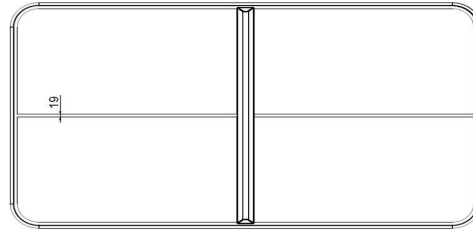
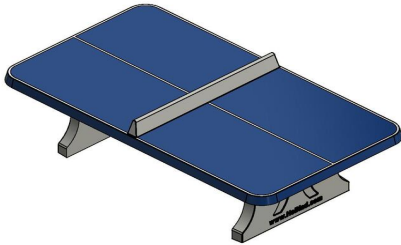

HeBlad
www.HeBlad.com
PP.AR.BL
Gewicht ± 1360 KG

Specifications Blue table tennis table, rounded

Product code	PP.AR.BL	Height tabletop	76 cm
Colour	Blue - RAL 5005	Height of the net	14,75 cm
Dimension playing surface (L x W)	274 x 152 cm	Weight	1360 kg
Dimensions bottom of playing surface	279 x 157 cm	Distance legs	183 cm (center to center)
Tabletop thickness	8,4 cm		

Related products



PP.NT



PP.R.GR



B.S1



OP.PP



B.DS.SP

Our products are delivered from our factory in the Netherlands.



Concrete Ping-pong table anthracite, rounded

Product code: PP.AR.A

£ 2,900.00 excl. VAT
(£ 3,480.00 incl. VAT)

In addition to Heblad's standard table tennis tables, we designed the concrete table tennis table with rounded corners in, among other things, the colour anthracite. The rounded corners make it possible for even the youngest children to play a game of ping pong safely, because the risk of bumping into the sharp corners is removed.

The power of the concrete table tennis table rounded anthracite

The concrete table tennis table with rounded corners is cast from one piece of concrete. The table top, the net and the legs are all cast in 1. This makes the table strong and makes it so that you can enjoy years of carefree playing pleasure. This ping pong table is a nice addition to your site, park or garden. This concrete table tennis table with rounded corners has an anthracite lacquer layer. The two-component lacquer with which the table top is treated and with which the white lines are drawn is of such good quality that it does not flake off. The table tennis table therefore retains its chic appearance. The applied top and bottom reinforcement makes the table extra strong and immovable to vandals. A sturdy, robust table with a chic colour!

Combine the concrete table tennis table rounded anthracite

Do you like the colour anthracite? Then the standard anthracite oval concrete bench would look great next to the anthracite table tennis table. The oval shape of the bench fits nicely with the rounded corners of the table tennis table. The standard anthracite concrete bench would also be an asset next to the table tennis table. In addition to the fact that these colours form a unity on your site, the

3 April 2025 - Prices subject to change

Our products are delivered from our factory in the Netherlands.



correspondence address

HeBlad - UK

The Balance, 7th floor, Pinfold Street
S1 2GU Sheffield, South Yorkshire
T. 0114 352 0110
info@HeBlad.co.uk
www.HeBlad.co.uk

head office address

HeBlad BV

Diamantweg 22
NL - 5527 LC Hapert

benches also provide seating for spectators and at the same time form a beautiful separation from a different part of the terrain. If you place the benches in front of a building, you even have good armor against ram raids, for example.

Contact Heblad

A team of specialists is ready to answer all your questions about Heblad products, the options for your location, the delivery conditions and times. Please feel free to contact us, we are happy to think along with you.

Our products are delivered from our factory in the Netherlands.

Registered under: HeBlad BV • HM Revenue and Customs • Ruby House 8 • Ruby Place • AB10 1ZP Aberdeen
VAT Number GB381060225 • EORI Number GB381060225000 • Commercial register (NL) 170 66 364
Rabobank De Kempen, Markt 7, 5531 BA Bladel (NL) • BIC RABONL2U • Branch code RABONL2UXXX • IBAN NL 20 RABO 0107530112 GBP

Specifications Concrete Ping-pong table anthracite, rounded

head office address

Product code	PP.AR.A	Height tabletop	76 cm	HeBlad BV
Colour	Anthracite - RAL 7016	Height of the net	14,75 cm	Diamantweg 22
Dimension playing surface (L x W)	274 x 152 cm	Weight	1360 kg	NL - 5527 LC Hapert
Dimensions bottom of playing surface	279 x 157 cm	Distance legs	183 cm (center to center)	
Tabletop thickness	8,4 cm			

Related products



PP.AR.BL



HB.FB.A



BB.DL.A



B.S1



B.DS.SP

Our products are delivered from our factory in the Netherlands.



Ping-pong table rounded, Anthracite-Concrete

Product code: PP.AR.AB

£ 3,000.00 excl. VAT
(£ 3,600.00 incl. VAT)

Chic, natural and robust. A table tennis table with rounded corners in a beautiful anthracite colour. Less striking than the blue or green version, this colour actually gives a chic look. Of course, this table, just like the classic version, is made of solid concrete. When do you choose the table with rounded corners? When your goal is to go for safety! The chance of bruising with this ping pong table is smaller than with the classic model because the corners of the ping pong table are rounded. A robust, sturdy, outdoor table tennis table where young and old can participate in a game 'around the table'.

Guaranteed fun with the ping pong table with rounded corners

How does Heblad guarantee quality? All Heblad ping pong tables are equipped with top and bottom reinforcement. Just like our other game tables, this table tennis table with rounded corners cannot be dismantled. The entire table - the table top, the net and the legs - is cast from one piece of concrete. This means that the risk of damage is minimal and we can guarantee years of fun on our concrete game tables. This table tennis table in anthracite-concrete colour with rounded corners has a chic look. The concrete ping pong tables from Heblad will give you a lot of table tennis fun for a long time!

Combine concrete table tennis table

This table tennis table provides a lot of fun. And especially when you combine this game table with other game tables at your location. Or how about a game table where you can play chess or checkers? Or add a picnic set! Do you have the space and would you like to encourage exercise? Then consider adding the

3 April 2025 - Prices subject to change

Our products are delivered from our factory in the Netherlands.



correspondence address

HeBlad - UK

The Balance, 7th floor, Pinfold Street
S1 2GU Sheffield, South Yorkshire
T. 0114 352 0110
info@HeBlad.co.uk
www.HeBlad.co.uk

head office address

HeBlad BV

Diamantweg 22
NL - 5527 LC Hapert

Heblad game tables for foot volleyball or table football to your space. In this way you create an active, pleasant playing environment in the outdoor air.

Variants of table tennis tables

Are you looking for a concrete table tennis table with rounded corners, but would you rather choose a different colour? Then consider the blue and natural versions. Or would you prefer a different shape? That's also possible! In addition to the rounded corners, we also have the classic version without rounded corners and even an elegant round version. In all cases, you choose a sustainable product with Heblad products. Please feel free to contact us for any questions about our products!

View the other versions of this ping pong table with rounded corners in green, blue, anthracite or natural concrete.

** When purchasing a Heblad ping pong table, a set of bats (4 bats and 2 balls) is included for free.

Our products are delivered from our factory in the Netherlands.

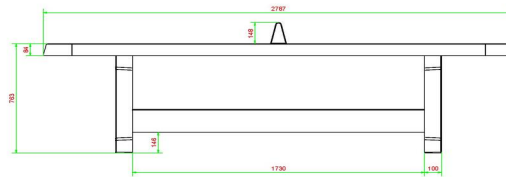
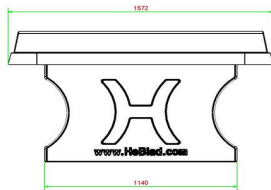
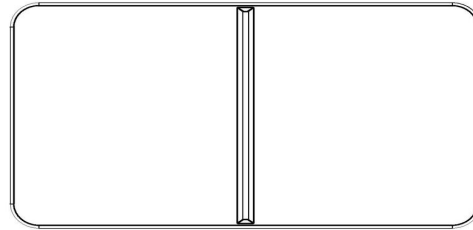
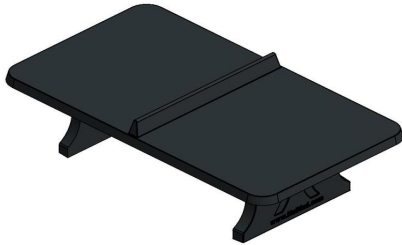

HeBlad
www.HeBlad.com
PP.AR.AB
Gewicht ± 1360 KG

Specifications Ping-pong table rounded, Anthracite-Concrete

Product code	PP.AR.AB	Height tabletop	76 cm
Colour	Anthracite concrete	Height of the net	14,75 cm
Dimension playing surface (L x W)	274 x 152 cm	Weight	1360 kg
Dimensions bottom of playing surface	279 x 157 cm	Distance legs	183 cm (center to center)
Tabletop thickness	8,4 cm		

Related products



PP.R.AB



PP.AR.BL



OP.PP.AB



B.DS.SP



VV.NT

Our products are delivered from our factory in the Netherlands.



Ping-pong table rounded, Natural Concrete

Product code: PP.AR.NT

£ 2,850.00 excl. VAT
(£ 3,420.00 incl. VAT)

Our concrete table tennis tables are an absolute asset to any public space, campsite, garden or playground. Why rounded corners? The table is made of high-quality natural concrete, which is an extremely hard material. The rounded corners make this table safe to use. You can run around the table and play, with less chance of hitting yourself against the treacherous points. That is why younger children can also play a game of table tennis safely.

As we say in Dutch, 'After all, learned young is done old'.

How do you get better at table tennis? Provide good equipment, analyze the opponent, train on the serve, play varied, and, most importantly, play often. Practice makes perfect.

Fortunately, Heblad table tennis tables last a lifetime and the bats and balls are included.

What colour is the table tennis table available in?

You choose this ping pong table because of the colour: it has a calm, beautiful appearance. This is also due to the rounded corners. This makes the table a safe solution that you can easily place anywhere. The table has a perfect playing height for children and adults.

This ping pong table is also available in a blue and green version. Choose the colour that best suits your environment and let us install it professionally. An absolute must-have that should not be missing in any garden, playground or park.

What characterizes the concrete ping pong table?

This concrete table tennis table is characterized by its simple but above all robust

3 April 2025 - Prices subject to change

Our products are delivered from our factory in the Netherlands.



correspondence address

HeBlad - UK

The Balance, 7th floor, Pinfold Street
S1 2GU Sheffield, South Yorkshire
T. 0114 352 0110
info@HeBlad.co.uk
www.HeBlad.co.uk

head office address

HeBlad BV

Diamantweg 22
NL - 5527 LC Hapert

and safe design. It is a gaming table that is available in different versions. The fact that we have paid care and attention to quality is immediately reflected in the product features.

- Colour: natural concrete, anthracite, green and blue
- Play top size 274 x 152 cm
- Play top height 76 cm
- Material: solid concrete, cast in one piece.

Order table tennis table online

Can the table tennis table be ordered online? You can easily order all Heblad products via the website.

When you order from Heblad, you directly order from the manufacturer. This way we can assure you of the best quality possible.

Heblad products are easy to combine. Each design is made to be able to combine with other products on the playground. A robust bench, a picnic table or a game table, all products are made from the same concrete and are therefore always matching. Do you have any questions about the range? We are happy to help you make a choice or convince you of the added value that this product has. Please feel free to contact us, we are ready to help you!

** When purchasing a Heblad ping pong table, a set of bats (4 bats and 2 balls) is included for free.

Our products are delivered from our factory in the Netherlands.

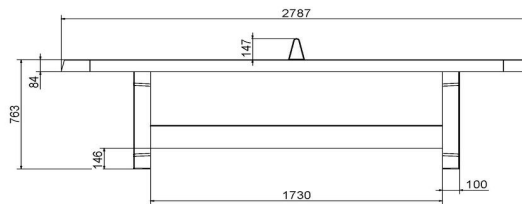
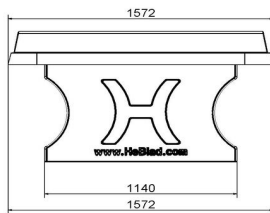
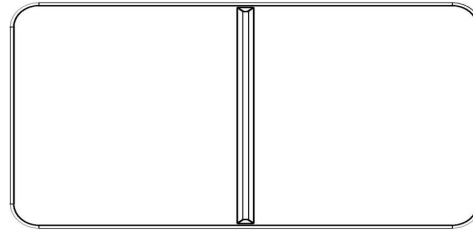
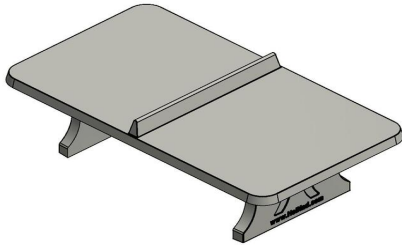

HeBlad
www.HeBlad.com
PP.AR.NT
Gewicht ± 1360 KG

Specifications Ping-pong table rounded, Natural Concrete

Product code	PP.AR.NT	Height tabletop	76 cm
Colour	Natural concrete	Height of the net	14,75 cm
Dimension playing surface (L x W)	274 x 152 cm	Weight	1360 kg
Dimensions bottom of playing surface	279 x 157 cm	Distance legs	183 cm (center to center)
Tabletop thickness	8,4 cm		

Related products



PP.R.BL



PP.GR



B.DS10



OP.PP

Our products are delivered from our factory in the Netherlands.



Picnic table Standard Oval Natural Concrete

Product code: PS.ST.OV

£ 2,650.00 excl. VAT
(£ 3,180.00 incl. VAT)

With our oval picnic set you always have a place to sit. You can enjoy a snack or a drink, or just have a chat or enjoy the surroundings. This picnic set is a real eye-catcher because of its design and because it is made from one piece and has beautiful oval and round shapes. Once in place, this table cannot be moved and you can be sure that you will enjoy using it for many years to come. The picnic set can be supplied with or without a base plate and is available in three colours: natural concrete, anthracite-concrete and anthracite.

Ideal concrete picnic set

This picnic set is a real asset to public spaces. It is an ideal choice in places where there is no supervision. Due to its weight and the fact that the set cannot be dismantled, it is a perfect solution if you want to create a seating area somewhere where supervision is not always possible. You can think of a square, at school, in the park, on a terrace or next to your snack bar. Once this table is in place, you don't have to worry about theft or storms, because it cannot be blown over or taken away.

The different picnic sets

The oval picnic set is made from one piece of cast concrete and is available in a natural concrete colour, a dark gray concrete colour and anthracite. You can order a base plate so that it is stable. If opt for no base plate, the appearance of the table is even more organic and friendly. It is a beautiful table to place in a space with a beautiful view. Because the entire picnic set is so beautifully designed, it is a real asset to any environment.

3 April 2025 - Prices subject to change

Our products are delivered from our factory in the Netherlands.



correspondence address

HeBlad - UK

The Balance, 7th floor, Pinfold Street
S1 2GU Sheffield, South Yorkshire
T. 0114 352 0110
info@HeBlad.co.uk
www.HeBlad.co.uk

head office address

HeBlad BV

Diamantweg 22
NL - 5527 LC Hapert

Quality as you have come to expect from us

All our tables are made from one piece and this picnic set is no exception. The tabletop is 7 cm thick, the table weighs almost a thousand kilos and the tabletop is more than 2 meters long. With our oval picnic set you can also count on the high quality you have come to expect from us.

Do you have any questions? Please feel free to contact us!

* The base plate is optional

Our products are delivered from our factory in the Netherlands.

Registered under: HeBlad BV • HM Revenue and Customs • Ruby House 8 • Ruby Place • AB10 1ZP Aberdeen
VAT Number GB381060225 • EORI Number GB381060225000 • Commercial register (NL) 170 66 364
Rabobank De Kempen, Markt 7, 5531 BA Bladel (NL) • BIC RABONL2U • Branch code RABONL2UXXX • IBAN NL 20 RABO 0107530112 GBP

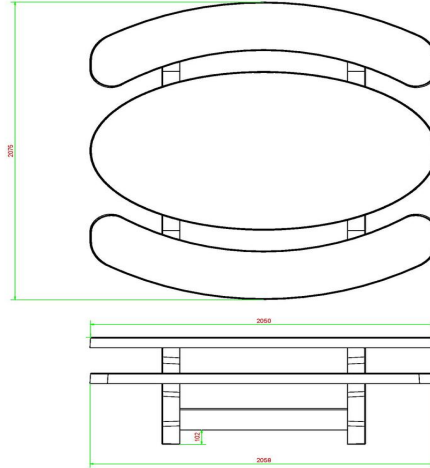
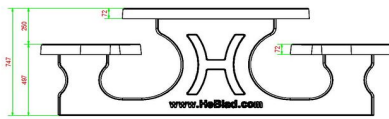
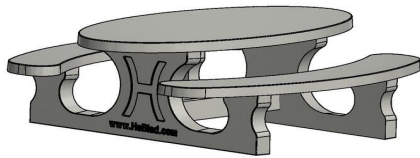

HeBlad
www.HeBlad.com
PS.ST.OV
± 950 KG.

Specifications Picnic table Standard Oval Natural Concrete

Product code	PS.ST.OV	Seat height	50 cm
Colour	Natural concrete	Material seat	Beton
Dimensions (L x W x H)	211 x 205 x 75 cm	Distance legs	110 cm (center to center)
Dimensions tabletop (L x W)	205 x 110 cm	Weight	950 kg
Tabletop thickness	7 cm	Number of seats	8

Related products 75 cm



PS.STAB.OV



PS.STA.OV



PS.DL.OV



OP.PS



PS.ST.XL

Our products are delivered from our factory in the Netherlands.



Picnic table Standard Oval Anthracite-Concrete

Product code: PS.STAB.OV

£ 2,800.00 excl. VAT
(£ 3,360.00 incl. VAT)

A beautiful oval picnic set

A little different from the standard picnic sets... Due to the oval shape, this picnic set provides welcome seating for several people. Visitors can have conversations easier because of the angle they're sitting at, and the location where the set is located is uniquely decorated. Both a practical and an aesthetic bonus!

Placement of the anthracite oval picnic set

Due to the weight and size of the picnic set, it is important to know the delivery conditions. By determining in advance whether your space is suitable for the picnic set, we prevent problems. What are the dimensions of a picnic set? This oval picnic set has a total size of 211 x 205 x 75 cm. The tabletop measures 205 x 110 cm and is placed at a height of 75 cm. The seats have a seat height of 50 cm. To ensure that the picnic set fits your location, you must also take into account walking space around the set. If you have the space, then this oval, concrete picnic set is perfect for you.

Picnic sets from HeBlad

Which brand of picnic set should you choose? It is important that you know where you are going to place the set, how intensively it will be used and how long its lifespan should be.

Because all HeBlad products are made from one piece of concrete and are unfazed by being left outside for years, HeBlad picnic sets assure you of a beautiful and functional picnic set in your outdoor area for years to come.

Products from HeBlad

3 April 2025 - Prices subject to change

Our products are delivered from our factory in the Netherlands.



correspondence address

HeBlad - UK

The Balance, 7th floor, Pinfold Street
S1 2GU Sheffield, South Yorkshire
T. 0114 352 0110
info@HeBlad.co.uk
www.HeBlad.co.uk

head office address

HeBlad BV

Diamantweg 22
NL - 5527 LC Hapert

HeBlad products can be perfectly combined with each other. Are you looking for more activities to add to the picnic set? Have you already considered the foot volleyball game? In the same design style as the picnic set, you can challenge visitors to a game of foot volleyball, without spoiling the appearance of your location. Are you looking for some competitiveness, but are not fond of balls flying around? You might just want to take a look at our table football table. It's a sturdy product, where multiple people can play at the same time.

Perhaps you are thinking of another HeBlad gaming table or one of the other products? Please feel free to contact us. We can discuss the options, and maybe even help you with some customisation.

Our products are delivered from our factory in the Netherlands.

Registered under: HeBlad BV • HM Revenue and Customs • Ruby House 8 • Ruby Place • AB10 1ZP Aberdeen
VAT Number GB381060225 • EORI Number GB381060225000 • Commercial register (NL) 170 66 364
Rabobank De Kempen, Markt 7, 5531 BA Bladel (NL) • BIC RABONL2U • Branch code RABONL2UXXX • IBAN NL 20 RABO 0107530112 GBP

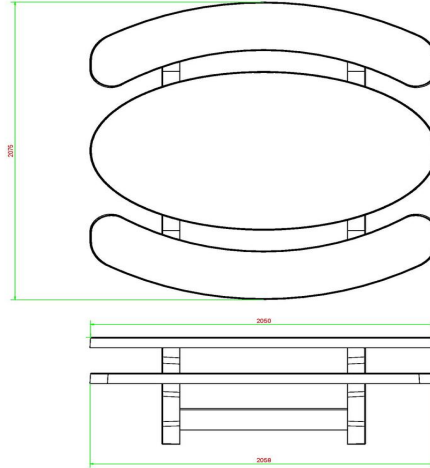
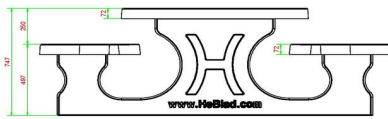
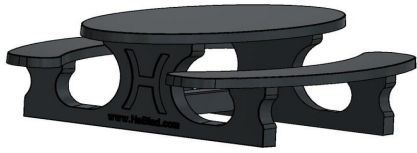

HeBlad
www.HeBlad.com
PS.STAB.OV
± 950 KG.

Specifications Picnic table Standard Oval Anthracite-Concrete

Product code	PS.STAB.OV	Seat height	50 cm
Colour	Anthracite concrete	Material seat	Beton
Dimensions (L x W x H)	211 x 205 x 75 cm	Distance legs	110 cm (center to center)
Dimensions tabletop (L x W)	205 x 110 cm	Weight	950 kg
Tabletop thickness	7 cm	Number of seats	8

Related products 75 cm



PS.ST.OV



PS.STA.OV



PS.DLAB.OV



OP.PS.AB



PS.STAB.XL

Our products are delivered from our factory in the Netherlands.



Concrete Picnic table Standard Oval Anthracite

Product code: PS.STA.OV

£ 2,750.00 excl. VAT
(£ 3,300.00 incl. VAT)

The well-known ping pong tables from HeBlad

HeBlad has grown because of its ping pong tables. They are indestructible and last for years because they can withstand the most extreme weather conditions. While maintaining a strong appearance and functionality, you will find the ping pong tables at sports fields, campsites, playgrounds at schools and in parks. You will regularly find HeBlad gaming tables far beyond the borders of the UK. We have used the same quality that we put into the ping pong tables for the entire range of game tables, benches, picnic sets, foot volleyball tables and table football tables.

Beautiful anthracite lacquered, oval picnic set

Imagine: you are looking for a picnic set that makes your site more beautiful and can also remain outside for years. What is the best outdoor picnic set? Look no further. Heblad offers everything you might desire. If you like oval shapes, an elegant anthracite colour and little maintenance required, then this standard anthracite oval picnic set is exactly what you want. The unusual shape gives a playful impression, the colour provides that graceful little extra and the strength comes from the high quality concrete.

The picnic set standard anthracite oval

An important question to ask when you intend to order a picnic set: what should I pay attention to when buying a picnic set? Determine in advance the exact location where the picnic set will be placed and whether the location is accessible

3 April 2025 - Prices subject to change

Our products are delivered from our factory in the Netherlands.



correspondence address

HeBlad - UK

The Balance, 7th floor, Pinfold Street
S1 2GU Sheffield, South Yorkshire
T. 0114 352 0110
info@HeBlad.co.uk
www.HeBlad.co.uk

head office address

HeBlad BV

Diamantweg 22
NL - 5527 LC Hapert

for delivery of the set. The minimum requirements for location and delivery can be found in our delivery conditions, but you can always contact us if you have any further questions. The dimensions of the standard anthracite oval picnic set are a total of 211 x 205 x 75 cm, but you should take into account some extra space to move around the set.

Discount on HeBlad's concrete picnic sets

If you have the space, it would be a great asset to provide your location with several picnic sets or game tables, both for the appearance of the location and for gaming and seating pleasure. This makes purchasing multiple products at HeBlad interesting. When you order more than one product, you receive a discount on your total. This discount depends on the amount of products purchased. Are you curious about your discount or do you have other questions about HeBlad products? Please contact us, we will be happy to advise you.

Our products are delivered from our factory in the Netherlands.

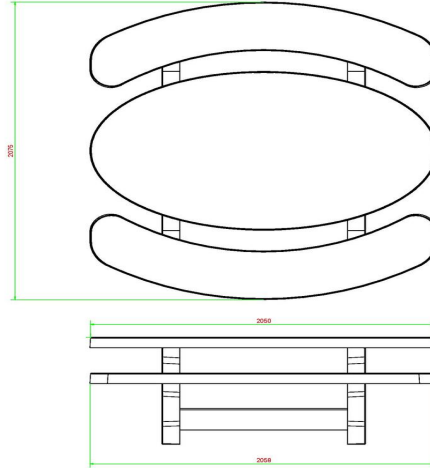
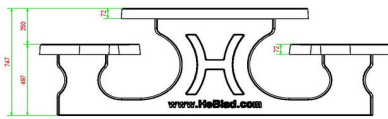
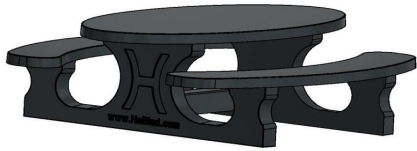

HeBlad
www.HeBlad.com
PS.STA.OV
± 950 KG.

Specifications Concrete Picnic table Standard Oval Anthracite

Product code	PS.STA.OV	Seat height	50 cm
Colour	Anthracite lacquered, RAL 7016	Material seat	Beton
Dimensions (L x W x H)	211 x 205 x 75 cm	Distance legs	110 cm (center to center)
Dimensions tabletop (L x W)	205 x 110 cm	Weight	950 kg
Tabletop thickness	7 cm	Number of seats	8

Related products



PS.ST.OV



PS.STAB.OV



PS.DLA.OV



OP.PS.AB



PS.STA.XL

Our products are delivered from our factory in the Netherlands.



Bottom plate Picnic table Natural Concrete

Product code: OP.PS

£ 1,725.00 excl. VAT
(£ 2,070.00 incl. VAT)

A base plate is used to keep the immediate surroundings of a picnic set tidy. It prevents weeds or grass from growing under the picnic set. The space around the base plate is easy to maintain, because the base plate is placed at cutting height. The base plate is also ideal for placing the picnic set stably on an uneven surface or on softer grounds.

What is the base plate made of?

Like all other HeBlad products, the base plates are made of concrete. They have an anti-slip profile in the form of a criss-cross pattern. This finish ensures that neither the visitors or players or the table can slip on the base plate.

Delivery and installation of the base plate

If you ensure that the sand bed is prepared at the correct height, we will deliver the base plate and place it in the right location. In order to actually deliver the base plate to the right place, it is important that we can park our truck no more than five meters away. The base plate is placed in the right place from the truck with the crane. If you have any questions about installation and delivery, please read the terms and conditions of delivery or contact us. Please note that the base plate is always optional, it is never included in the price of a picnic set.

Which models of picnic sets fit on the base plate?

In principle, all HeBlad picnic set models fit on the base plate measuring 248 x 236 x 7 cm, both the standard picnic sets and the oval picnic sets, as well as the

3 April 2025 - Prices subject to change

Our products are delivered from our factory in the Netherlands.



correspondence address

HeBlad - UK

The Balance, 7th floor, Pinfold Street
S1 2GU Sheffield, South Yorkshire
T. 0114 352 0110
info@HeBlad.co.uk
www.HeBlad.co.uk

head office address

HeBlad BV

Diamantweg 22
NL - 5527 LC Hapert

wheelchair-accessible sets. The XL picnic sets require two base plates.

Base plate for ping pong tables

Base plates can also be ordered for our game tables and ping-pong tables. Here too, plates must be ordered additionally, they do not automatically come with the product. If you want to be sure of the correct base plate or perhaps you are unsure whether a base plate is necessary, please contact us. We are happy to advise you.

Our products are delivered from our factory in the Netherlands.

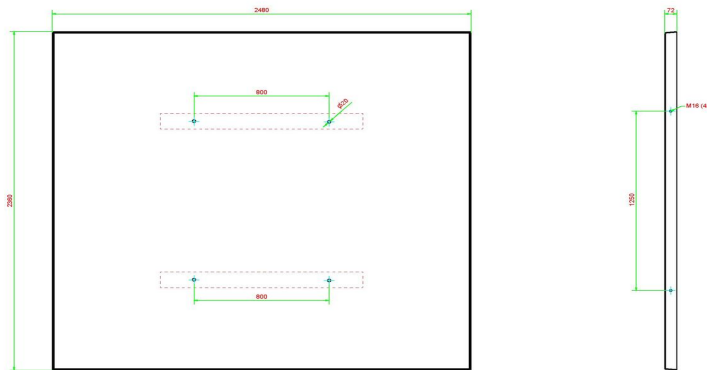

HeBlad
www.HeBlad.com
OP.PS
Gewicht ± 1000 KG.

Specifications Bottom plate Picnic table Natural Concrete

Product code	OP.PS	Weight	1000 kg
Colour	Natural concrete	lifting device	Concrete screw sleeve M16 on 4 sides
Dimensions (L x W x H)	248 x 236 x 7 cm	preparation attachment	Holes for bolts M16
Finishing base plate	Anti-slip (window) profile		

Related products



PS.DL



PS.ST



PS.DL.OV



OP.PS.AB



PS.ST.OV

Our products are delivered from our factory in the Netherlands.



Bottom plate Picnic table Anthracite-Concrete

Product code: OP.PS.AB

£ 1,825.00 excl. VAT
(£ 2,190.00 incl. VAT)

What is the added value of a base plate? It can be an aesthetic choice to place a base plate under the standard anthracite concrete picnic set. Simply because you find that more attractive than having the picnic set 'loose' in the space. It is also common that the surface on which the picnic set is placed is too soft to bear the weight of the set or that the surface is not even. A base plate is the ideal solution against unwanted growth of moss, grass or weeds under the table and seats.

Specifications concrete base plate anthracite concrete

What does the concrete base plate from HeBlad weigh? The weight of the anthracite concrete base plate for the picnic set is 1000 kg. The base plate distributes the weight of the picnic set (905 kg) over the entire surface of the plate. The dimensions of the plate are 248 x 236 x 7 cm. The entire plate is provided with an anti-slip diamond profile and has pre-drilled holes for M16 bolts with which the picnic set is secured to the plate.

Variants of the concrete base plate

The base plate for the standard picnic sets is also available in the colour natural concrete. This plate has the same specifications and dimensions, but in the neutral concrete colour. Specifically for the picnic sets with a length of 246 cm, we make the base plate anthracite concrete 246, it has a dimension of 245 x 300 x 10 cm and weighs 1700 kg. These large base plates can also be ordered in the colours natural concrete and anthracite concrete.

Base plate picnic set or table tennis table

Base plates are also available for HeBlad table tennis tables. The base plate ping-pong table anthracite concrete and the base plate ping-pong table natural

3 April 2025 - Prices subject to change

Our products are delivered from our factory in the Netherlands.



correspondence address

HeBlad - UK

The Balance, 7th floor, Pinfold Street
S1 2GU Sheffield, South Yorkshire
T. 0114 352 0110
info@HeBlad.co.uk
www.HeBlad.co.uk

head office address

HeBlad BV

Diamantweg 22
NL - 5527 LC Hapert

concrete have a dimension of 299 x 179 x 10 cm, a weight of 1270 kg and are made of smooth concrete. The holes for the attachment of the ping-pong table have already been pre-drilled in exactly the right places.

Delivery of base plate

Due to the size and weight of the base plates, it is important that we can come within five meters of the installation location with our delivery truck. We always ask for the ground to be prepared in advance, i.e. to dig it out in the right place at the right depth. We can then use our crane to perfectly place the base plate directly from the truck. Please contact us if there are any doubts or questions.

Our products are delivered from our factory in the Netherlands.

Registered under: HeBlad BV • HM Revenue and Customs • Ruby House 8 • Ruby Place • AB10 1ZP Aberdeen
VAT Number GB381060225 • EORI Number GB381060225000 • Commercial register (NL) 170 66 364
Rabobank De Kempen, Markt 7, 5531 BA Bladel (NL) • BIC RABONL2U • Branch code RABONL2UXXX • IBAN NL 20 RABO 0107530112 GBP

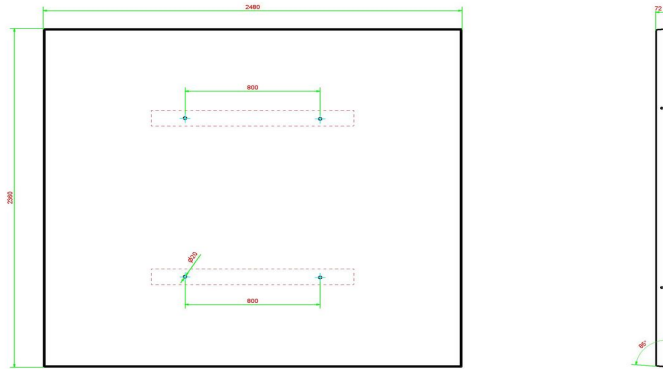

HeBlad
www.HeBlad.com
OP.PS.AB
Gewicht ± 1000 KG.

Specifications Bottom plate Picnic table Anthracite-Concrete

Product code	OP.PS.AB	Weight	1000 kg
Colour	Anthracite concrete	lifting device	Concrete screw sleeve M16 on 4 sides
Dimensions (L x W x H)	248 x 236 x 7 cm	preparation attachment	Holes for bolts M16
Finishing base plate	Anti-slip (window) profile		

Related products



PS.DL.A



PS.ST.A



PS.DLAB.OV



OP.PS



PS.STAB.OV

Our products are delivered from our factory in the Netherlands.



Starter package table tennis bats & balls

Product code: B.DS.SP

£ 72.00 excl. VAT
(£ 86.40 incl. VAT)

A table tennis table is nothing without bats and balls. Every HeBlad ping pong table comes standard with four bats and two balls. Of course you never want to be without these accessories. That is why it is wise to build up a large stock.

The starter package consists of 100 ping pong balls and 10 bats. The balls are white and the bats have the colours red, yellow, blue and green.

What is the delivery time of the starter pack of bats and balls?

When ordering accessories from HeBlad you are assured of fast delivery. We ship immediately the day after the order is received and paid for.

If you ordered the starter package together with a table tennis table from HeBlad, you will receive the package together with the game table and you will also benefit from a nice discount.

Bats and balls and other accessories

We offer various accessories for the table tennis game. You can choose other colours of bats, like pink and blue. Or you can create a large assortment of 10 sets with plastic bats and balls. Are you afraid that the balls will quickly get lost? We also have a solution for that: 100 ping pong balls in one box.

Contact HeBlad

Do you have any questions about HeBlad table tennis table accessories or our other products? Please contact us. We are happy to advise you.

3 April 2025 - Prices subject to change

Our products are delivered from our factory in the Netherlands.

Specifications Starter package table tennis bats & balls

Product code	B.DS.SP
Material	Kunststof

head office address

HeBlad BV
Diamantweg 22
NL - 5527 LC Hapert

Related products



PP.AR.BL



HB.FB.A



B.DS10

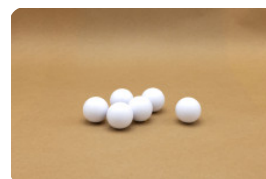

HB.FB.Ball6

Our products are delivered from our factory in the Netherlands.



Plastic all-weather table tennis paddles in 4 colours

Product code: B.S1

£ 15.00 excl. VAT
(£ 18.00 incl. VAT)

To make optimal use of your ping pong table, you need a table tennis bat and ball. At HeBlad you can also order the necessary accessories for your ping pong table. This set consists of 4 table tennis bats in different colours and 2 ping pong balls.

Table tennis bats for outdoor use

The table tennis bats are ideal for outdoor use. They are made of plastic, which makes the bats very sturdy and able to withstand a blow. Very useful if groups of children are going to use this. Because the ping pong bats are made of plastic, they are easy to wash. This is of course pleasant for large-scale use at schools and campsites, for example. The table tennis bats can be cleaned with a simple cleaning agent or dishwashing soap. You don't have to worry about a ping pong bat losing its colour.

Table tennis bats in bright colours

These table tennis bats are available in four different bright colours, namely yellow, green, red and blue. These colours are appealing to children. They pick up the bats and start playing actively quicker. But that's not the only reason. The bright colours make the bats clearly visible and you can easily find them if children leave them in a random place.

Accessories for table tennis table

You can easily order the ping pong bats on our website. In addition to this set of 4 bats with 2 balls, you can also choose a package containing 10 of these sets. Or choose the starter package. A box with no less than 100 ping pong balls and 10 table tennis bats in the colours red, yellow, blue and green. The ping pong balls

3 April 2025 - Prices subject to change

Our products are delivered from our factory in the Netherlands.



correspondence address

HeBlad - UK

The Balance, 7th floor, Pinfold Street
S1 2GU Sheffield, South Yorkshire
T. 0114 352 0110
info@HeBlad.co.uk
www.HeBlad.co.uk

head office address

HeBlad BV

Diamantweg 22
NL - 5527 LC Hapert

are available per 6 or per 100. You will also find the necessary accessories for our other game and play tables: chess pieces, checkers, table football figures and balls: view our page about the various accessories.

Our products are delivered from our factory in the Netherlands.

Registered under: HeBlad BV • HM Revenue and Customs • Ruby House 8 • Ruby Place • AB10 1ZP Aberdeen
VAT Number GB381060225 • EORI Number GB381060225000 • Commercial register (NL) 170 66 364
Rabobank De Kempen, Markt 7, 5531 BA Bladel (NL) • BIC RABONL2U • Branch code RABONL2UXXX • IBAN NL 20 RABO 0107530112 GBP

Specifications Plastic all-weather table tennis paddles in 4 colours

Product code	B.S1
Material	Kunststof

head office address

HeBlad BV
Diamantweg 22
NL - 5527 LC Hapert

Related products



PP.AR.GR



HB.FB.A



B.DS.SP



GT.CH.Pieces

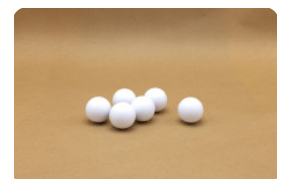

HB.FB.Ball6

Our products are delivered from our factory in the Netherlands.



box with 10 sets of table tennis bats

Product code: B.DS10

£ 125.00 excl. VAT
(£ 150.00 incl. VAT)

Always be sure of playing fun on the table tennis table. With this stock of 10 sets of bats and balls, you can never go wrong. Because the sets are packaged separately, four bats with two balls, these plastic sets are also very easy to resell in, for example, the camping shop. This way you can offer your customers extra playing pleasure during their stay at your campsite.

Accessories from HeBlad

Every HeBlad game table, ping pong table, foot volleyball table or table football table comes with accessories to play the game properly. Each table is supplied with the associated accessories as standard, but these parts can also be ordered separately. This way you ensure that you always have the right materials to play the games. Just like HeBlad's gaming tables, the accessories are also made from raw materials that can be used outdoors without losing their colour or shape. HeBlad stands for reliability and honesty.

What is the delivery time of the plastic bats (10 sets)

When you place your order, we will ship your order immediately the next working day. If you have ordered the accessories from a gaming table, we will deliver everything in one delivery. Because we design, produce and deliver everything in-house, delivery times are short and communication is clear. If you have any questions about HeBlad's delivery conditions, products or accessories, please contact us.

3 April 2025 - Prices subject to change

Our products are delivered from our factory in the Netherlands.

Specifications box with 10 sets of table tennis bats

Product code	B.DS10
Material	Kunststof

head office address

HeBlad BV
Diamantweg 22
NL - 5527 LC Hapert

Related products



PP.R.BL



HB.FB.A

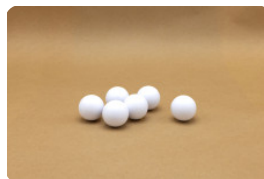

HB.FB.Ball6

Our products are delivered from our factory in the Netherlands.



Table tennis bats Pastel, set of 4

Product code: B.S1.pastel

£ 18.00 excl. VAT
(£ 21.60 incl. VAT)

With the same quality as the regular bats, we now have the version in the pastel colours pink and blue. A gentler approach to the game of table tennis. For example, this set of four bats and two balls fits very well with the low ping pong table from HeBlad, especially for the youngest children. The lower secondary students will be able to identify with the low table and soft colours of the bats. But the choice can of course also be made based on personal taste.

What are table tennis bats and balls made of?

Both the bats and balls are made of plastic. This makes them ideal for outdoor use: they can take a beating and are not sensitive to extreme weather conditions. The plastic is very easy to clean: just use detergent or dishwashing soap and warm water.

How much delivery time is there for the pink and blue table tennis bats? HeBlad's delivery times are short. If you order an accessory, we will ship it immediately the next working day. If you ordered the table tennis bats together with a ping pong table, you will receive the set of bats together with the table.

What is the alternative to the pink and blue table tennis bats

Tastes differ. That is why, in addition to this pastel set of table tennis bats, we also have the more standard colours red, yellow, green and blue. These four colours come in one set with two balls.

You can also purchase this standard set in bulk packaging. The starter pack of bats and balls consists of 100 balls and 10 bats. Or you order 10 sets of plastic bats, where a set consists of 4 bats and 2 balls.

Ask your question to HeBlad

Do you have any questions about our accessories, table tennis tables or other

3 April 2025 - Prices subject to change

Our products are delivered from our factory in the Netherlands.



correspondence address

HeBlad - UK

The Balance, 7th floor, Pinfold Street
S1 2GU Sheffield, South Yorkshire
T. 0114 352 0110
info@HeBlad.co.uk
www.HeBlad.co.uk

head office address

HeBlad BV

Diamantweg 22
NL - 5527 LC Hapert

game tables? Please contact us, we will be happy to advise you.

Our products are delivered from our factory in the Netherlands.

Registered under: HeBlad BV • HM Revenue and Customs • Ruby House 8 • Ruby Place • AB10 1ZP Aberdeen
VAT Number GB381060225 • EORI Number GB381060225000 • Commercial register (NL) 170 66 364
Rabobank De Kempen, Markt 7, 5531 BA Bladel (NL) • BIC RABONL2U • Branch code RABONL2UXXX • IBAN NL 20 RABO 0107530112 GBP

Specifications Table tennis bats Pastel, set of 4

Product code	B.S1.pastel
Material	Kunststof

head office address

HeBlad BV
Diamantweg 22
NL - 5527 LC Hapert

Related products



PP.AR.LOW.GR



PP.AR.LOW.BL



PP.AR.LOW.A



B.S1



B.DS10

Our products are delivered from our factory in the Netherlands.



Bag with 6 ping-pong balls

Product code: B.Z6

£ 8.00 excl. VAT
(£ 9.60 incl. VAT)

HeBlad's ping pong balls are of good quality and in the familiar white colour. Did you know that these ping pong balls are used as practice balls by table tennis clubs? They are that good! Because a ping pong table cannot do without ping pong balls and bats, HeBlad always supplies the ping pong tables with a free set of 4 bats and 2 balls. If you have lost these balls over time, you can also order separate accessories here, such as a set of 6 pieces of ping pong balls.

Order ping pong balls per bag of 6 pieces

You can easily order this set of ping pong balls in a bag of 6 by placing the order online. If you order multiple products you will also receive a discount. If you order the ping pong balls in combination with a ping pong table, both products will be delivered at the same time and you will automatically receive a discount.

Ping pong balls, bats and other accessories

In addition to the ping pong balls in a bag of 6, HeBlad supplies various other accessories associated with a ping pong table. Consider a complete Starter Package of Bats & Balls, consisting of no less than 100 balls and 10 bats. With high-quality plastic and bright colours, the bats are very appealing and with so many ping pong balls the players can play for a long time.

If the starter package is a bit too extensive for the way your ping pong table is used, we also have the option to opt for, for example, a set of 4 plastic table tennis bats. With this set you will receive 4 bats in different colours and 2 ping pong balls.

Big box of ping pong balls

Do you have several table tennis tables? Or would you simply like to have a stock

3 April 2025 - Prices subject to change

Our products are delivered from our factory in the Netherlands.



correspondence address

HeBlad - UK

The Balance, 7th floor, Pinfold Street
S1 2GU Sheffield, South Yorkshire
T. 0114 352 0110
info@HeBlad.co.uk
www.HeBlad.co.uk

head office address

HeBlad BV

Diamantweg 22
NL - 5527 LC Hapert

of table tennis balls? HeBlad has a box of ping pong balls (100 pieces) for heavy users and intensive table tennis players. If you order a box of 100 ping pong balls, you will receive a discount when you expand your order.

Order accessories online or by telephone

All HeBlad accessories can easily be ordered online, but we can also be reached by telephone for orders. Please feel free to contact us to order or to receive additional information about our gaming tables or accessories. We are happy to explain the specifications of a product to you or calculate your discount when placing an order.

Our products are delivered from our factory in the Netherlands.

Registered under: HeBlad BV • HM Revenue and Customs • Ruby House 8 • Ruby Place • AB10 1ZP Aberdeen
VAT Number GB381060225 • EORI Number GB381060225000 • Commercial register (NL) 170 66 364

Rabobank De Kempen, Markt 7, 5531 BA Bladel (NL) • BIC RABONL2U • Branch code RABONL2UXXX • IBAN NL 20 RABO 0107530112 GBP

Specifications Bag with 6 ping-pong balls

Product code	B.Z6
Material	Kunststof

head office address

HeBlad BV
Diamantweg 22
NL - 5527 LC Hapert

Related products



PP.R.GR



HB.FB.A



B.S1

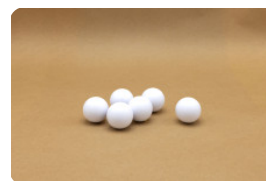

HB.FB.Ball6

Our products are delivered from our factory in the Netherlands.



Box of ping-pong balls packed per 100 pieces

Product code: B.DS100

£ 50.00 excl. VAT
(£ 60.00 incl. VAT)

With a large stock of ping pong balls, you always play the table tennis game with the right attributes. Just like the bats, the balls are made of plastic. This material can be easily cleaned and can be used outdoors.

The quality of the balls is so good that they are used by table tennis clubs as practice balls. But other associations and schools also order large quantities of balls from HeBlad. The delivery time is short, because we ship your order the day after you place the order with us.

There is also a discount for the box of 100 ping pong balls if you purchase multiple products at the same time from HeBlad.

Ping pong balls and table tennis tables

We will provide you with a free set of bats and balls with each table tennis table. And it is always up to you to decide what additional accessories to order. Do you have any questions about the delivery of the products and accessories? Please contact us, we will be happy to tell you more about the conditions and options.

3 April 2025 - Prices subject to change

Our products are delivered from our factory in the Netherlands.

Specifications Box of ping-pong balls packed per 100 pieces

Product code	B.DS100
Material	Kunststof

head office address

HeBlad BV
Diamantweg 22
NL - 5527 LC Hapert

Related products



PP.AR.AB



PP.BL



B.S1



B.DS.SP

Our products are delivered from our factory in the Netherlands.



1 Liter Green paint

Product code: HB.Paint-6009

£ 60.00 excl. VAT
(£ 72.00 incl. VAT)

Who doesn't know them, the green ping pong tables from HeBlad? Within Europe they are found on many campsites, on sports fields, schoolyards and even in public parks. Made from one piece of super strong concrete and provided with a beautiful green paint layer with white painted lines and net. A real shame if the green colour has faded, pieces of paint have been knocked off or dirt prevails on the table. Fortunately, you do not have to replace the entire table. With a new lick of paint the table will be like new again. RAL 6009 is the exact colour green that we use to treat the tables.

Green paint and other colours

What colours of paint are available? In addition to the traditional green paint, we also offer the colours in which we supply our ping pong tables: blue and anthracite. But you can also easily order the white paint for the lines and the net online. Each colour consists of a pot of finish (the colour) and a pot of hardening agent (gloss), so that your paint is well protected against the elements. Your table will be as good as new again and can last for years to come.

Green paint and other accessories

In addition to the paint for the ping pong tables, we have also included all accessories for our table football tables in our range. This means that with a small adjustment or repair you can enjoy years of gaming fun again. The tables are of such high quality that they can easily survive the paint and accessories.

Help from and contact with HeBlad

Are you unsure about the paint you want to use or do you need advice with your order? Then be sure to contact us. Together we find the right answers and

3 April 2025 - Prices subject to change

Our products are delivered from our factory in the Netherlands.



correspondence address

HeBlad - UK

The Balance, 7th floor, Pinfold Street
S1 2GU Sheffield, South Yorkshire
T. 0114 352 0110
info@HeBlad.co.uk
www.HeBlad.co.uk

head office address

HeBlad BV

Diamantweg 22
NL - 5527 LC Hapert

articles.

Our products are delivered from our factory in the Netherlands.

Registered under: HeBlad BV • HM Revenue and Customs • Ruby House 8 • Ruby Place • AB10 1ZP Aberdeen
VAT Number GB381060225 • EORI Number GB381060225000 • Commercial register (NL) 170 66 364
Rabobank De Kempen, Markt 7, 5531 BA Bladel (NL) • BIC RABONL2U • Branch code RABONL2UXXX • IBAN NL 20 RABO 0107530112 GBP

Specifications 1 Liter Green paint

Product code HB.Paint-6009

head office address

HeBlad BV
Diamantweg 22
NL - 5527 LC Hapert

Related products



HB.Paint-7016



HB.Paint-5005



PP.AR.GR



PP.GR



PP.AR.LOW.GR

Our products are delivered from our factory in the Netherlands.



1 Liter Blue paint

Product code: HB.Paint-5005

£ 60.00 excl. VAT
(£ 72.00 incl. VAT)

Is it possible to paint game tables? In specific regard of the blue table tennis tables and the blue foot volleyball tables from HeBlad, 1 liter of blue paint (RAL 5005) can be ordered. With this you can easily touch up flaking or damaged parts of the blue ping pong table. Repairing is also much more sustainable than replacing the whole table. If you want to give the entire table a makeover, you can also order white paint to repaint the net and the white lines. With a new coat of paint, your ping pong table will be as good as new and can last for years.

Can a ping pong table be repaired?

The table tennis tables and other game tables from HeBlad are made to be used for many years and they are resistant to all weather conditions. Of course, our tables can also be damaged unexpectedly. Often it is not necessary to immediately replace the entire game table if it is damaged. Small irregularities can easily be touched up with the repair set.

HeBlad loves sustainability

HeBlad stands for sustainability. We produce robust products that last a long time. That is why we also offer the possibility to revive or repair our gaming tables if the table requires it. In this way, we ensure decades of gaming fun, without loss of comfort or beauty.

Do you want to know how to make your table as good as new, or which table fits best on your terrain? Then contact us, we are happy to help you on your way.

3 April 2025 - Prices subject to change

Our products are delivered from our factory in the Netherlands.

Specifications 1 Liter Blue paint

Product code HB.Paint-5005

head office address

HeBlad BV
Diamantweg 22
NL - 5527 LC Hapert

Related products



HB.Paint-7016



HB.Paint-6009



PP.AR.BL



PP.BL



PP.AR.LOW.BL

Our products are delivered from our factory in the Netherlands.



1 liter anthracite paint

Product code: HB.Paint-7016

£ 60.00 excl. VAT
(£ 72.00 incl. VAT)

Can an anthracite foot volley table or table tennis table be painted? The anthracite-coloured game tables from HeBlad are supplied in the colour RAL 7016. You can purchase this colour in a 1-litre can via our webshop. This way, you never have to look at a damaged game table, because updating and refreshing the anthracite game table is child's play. This also applies to the other HeBlad colours: green and blue. You can use the white paint to repaint the lines and the net. You will also receive a special hardener with the paint; this layer of lacquer protects your paintwork against discolouration and other damages caused by the weather.

Concrete table tennis table anthracite

How long does the anthracite table tennis table last? This game table, like all other HeBlad products, is specifically designed and manufactured to serve outdoors for years without affecting its appearance or usability. Because we also promote sustainability, the game tables with minor signs of wear or damage can easily be repaired or refreshed with paint or a repair kit.

Contact HeBlad

What damage can be repaired on the anthracite game tables? With a repair kit, you can quickly remove minor irregularities with the filler and you can easily refresh your table with the right paint. If you are unsure about the extent of your damage, please contact us. We can easily estimate how best to repair your damage.

3 April 2025 - Prices subject to change

Our products are delivered from our factory in the Netherlands.

Specifications 1 liter anthracite paint

Product code HB.Paint-7016

head office address

HeBlad BV
Diamantweg 22
NL - 5527 LC Hapert

Related products



HB.Paint-5005



HB.Paint-6009



HB.FB.A



PS.DLA



PS.DLA.OV

Our products are delivered from our factory in the Netherlands.



1 liter white paint

Product code: HB.Paint-white

£ 60.00 excl. VAT
(£ 72.00 incl. VAT)

Do you want to freshen up the lines and the net of your table tennis table or your foot volleyball table? This can easily be done with the paint that you order online. The white colour of the lines and the net can fade, get damaged or discolour. You can provide the entire table with a new layer of lacquer, but if the concrete table tennis table still looks very nice, you can also just renovate the net and white playing lines. That is why you can order the special white paint from us. This includes a special layer of lacquer to keep the white paint looking good and to protect it against dirt and weather influences.

Paint for ping pong tables

In addition to the white paint for the lines and the net, it is also possible to paint the entire table top of the ping pong tables. What colours are the ping pong tables available in? The colours you can choose from are: natural concrete, anthracite concrete, anthracite lacquered, blue and green. Paint is available for the blue, green and anthracite ping-pong tables. With a lick of paint and hardener, your robust ping-pong table will be brand new again and ready for years of fun.

Contact HeBlad about paint

If you want to give your ping-pong table a different colour than it originally is, we recommend that you contact us in advance. We can advise you on the amount of paint and the working method. You can also call or email us for questions about our other products, delivery or product specifications. Our team of specialists will be happy to help you.

3 April 2025 - Prices subject to change

Our products are delivered from our factory in the Netherlands.

Specifications 1 liter white paint

Product code HB.Paint-white

head office address

HeBlad BV
Diamantweg 22
NL - 5527 LC Hapert

Related products



HB.Paint-7016



HB.Paint-5005



PP.AR.A



PP.AR.BL



PP.AR.GR

Our products are delivered from our factory in the Netherlands.



Concrete Table Football Table

Product code: HB.FB.A

£ 3,550.00 excl. VAT
(£ 4,260.00 incl. VAT)

This concrete table football table, like all other HeBlad products, is cast from one piece of concrete. This means that the base and the play area cannot be separated. No bolt or screw is required to put the table together. The concrete is of high quality, as you have come to expect from us, and as such is weather resistant.

What is the quality of the HeBlad football table?

The HeBlad table football table is robust and strong. The solid bars, goals and necessary screws are made of high-quality stainless steel. Even salty sea air does not damage or affect the parts. In addition, the football figures and score bars are made of unbreakable plastic. This is how we make our products strong and virtually impossible to break. To ensure that no rainwater remains in your table football table, holes have been made at the bottom of the goals. The corners in the play cabinet are sloping, allowing rainwater to easily drain from the play area.

What are the rules of table football?

The rules of the table football game differ between recreational play and professional play. In competitions, the first team to score 30 goals wins. The side also changes after 15 goals. For recreational level games, the count often goes up to 10 or 15. Every player is not allowed to clamp the ball between the field and the figure, for example to catch their breath. The ball must keep moving as much as possible. Full rotation of the rod used to operate the players is also prohibited. That is why the goalkeepers of our football tables in particular do not have the

3 April 2025 - Prices subject to change

Our products are delivered from our factory in the Netherlands.



correspondence address

HeBlad - UK

The Balance, 7th floor, Pinfold Street
S1 2GU Sheffield, South Yorkshire
T. 0114 352 0110
info@HeBlad.co.uk
www.HeBlad.co.uk

head office address

HeBlad BV

Diamantweg 22
NL - 5527 LC Hapert

ability to turn completely around. This prevents game cheating. The HeBlad table football tables are made entirely in accordance with the official dimensions and rules of the game.

What colour is the football table available in?

This table football table is lacquered in anthracite colour. You can put together your own teams for this table football table. You can choose from black, white, yellow, green, blue, purple, red and orange players. What colour do you prefer? You can easily combine our different HeBlad game and gaming tables. This way you can combine this table football table well with a concrete bench or picnic set. This allows you to take a break after a few games of table football.

Questions about the football table?

Do you have questions about the foosball table or another product? Please take a look at our FAQs (frequently asked questions) or contact us, we will be happy to help you. Are you interested in this table football table from HeBlad? Order this quickly, easily and safely on our website. When you purchase this table football table, six balls are included as standard so that you can immediately enjoy a game of table football.

Our products are delivered from our factory in the Netherlands.

Registered under: HeBlad BV • HM Revenue and Customs • Ruby House 8 • Ruby Place • AB10 1ZP Aberdeen
VAT Number GB381060225 • EORI Number GB381060225000 • Commercial register (NL) 170 66 364
Rabobank De Kempen, Markt 7, 5531 BA Bladel (NL) • BIC RABONL2U • Branch code RABONL2UXXX • IBAN NL 20 RABO 0107530112 GBP

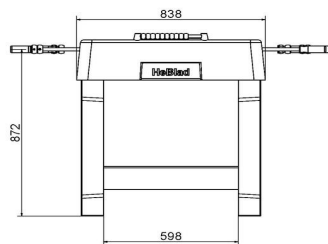
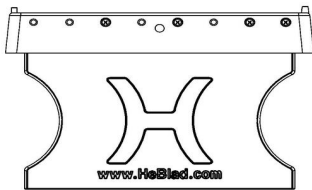
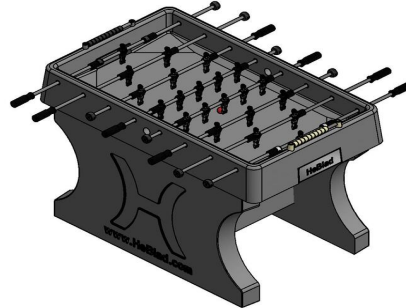
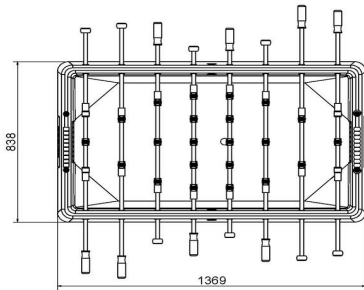

HeBlad
www.HeBlad.com
HB.FB.A
± 700KG

Specifications Concrete Table Football Table

Product code	HB.FB.A	Weight	700 kg
Colour	Anthracite lacquered, RAIDistance legs 7016		60 cm
Dimensions (L x W x H)	137 x 134 x 95 cm		

Related products



HB.FB.Bumperset



HB.FB.Handle

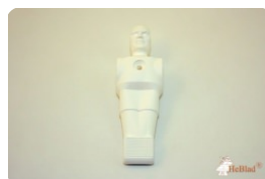

HB.FB.DOLL.Whit



HB.FBSC.set



HB.FB.Rodset

Our products are delivered from our factory in the Netherlands.



Checkers/Drafts Bench, Natural Concrete

Product code: BB.CK

£ 2,350.00 excl. VAT
(£ 2,820.00 incl. VAT)

A bench made from one piece of concrete with a natural look. A strong and sleek item for the schoolyard, in the park, at the campsite or in the garden. Because the game board is integrated into the top, the natural concrete checker bank can also be used as a table with seats. Because the checker bank is incredibly sturdy, it also provides immediate safety for the building in front of which the checker bank is placed. Introduce visitors of your outdoor area to the game of checkers. A set of checkers is supplied free of charge with each natural concrete checker bank. Brain sport for every generation, wonderful in the outdoors.

No need to worry about the checkerboard natural concrete, just enjoyment and safety

The natural concrete checker bank has a weight of no less than 1140 kg! This makes the checker bank insensitive to theft and provides protection against ram raids, for example. HeBlad is happy to think along with you about the best position to place the natural concrete checker bank, please feel free to contact us! The robustness of the natural concrete checkers bank does not detract from its beauty. With a perfect seat and table height, playing checkers becomes very attractive. A perfect 100-square game board and the included 20 white and 20 black stones are guaranteed to get users excited about the game of checkers.

Checkers bank natural concrete is easy to maintain

Because the natural concrete checkerboard is easy to maintain, you can maintain its nice and light colour. The sturdy concrete is easy to scrub clean and the top plate where the game board is located can easily be taken with you. HeBlad's

3 April 2025 - Prices subject to change

Our products are delivered from our factory in the Netherlands.



correspondence address

HeBlad - UK

The Balance, 7th floor, Pinfold Street
S1 2GU Sheffield, South Yorkshire
T. 0114 352 0110
info@HeBlad.co.uk
www.HeBlad.co.uk

head office address

HeBlad BV

Diamantweg 22
NL - 5527 LC Hapert

checkers stones are made for outdoor use and if any stones are lost, they can quickly be ordered separately online.

Please contact us for all your questions about the natural concrete checkers bank

Our professionals at HeBlad are ready to tell you everything about the natural concrete checkers bank. The specifications, the delivery conditions and of course the other game tables, benches and individual accessories. Contact us so we may help you with any questions you have.

*If the preliminary work has been done before delivery, installation is included in the price.

*When you order a checkers bank you will receive 1 set of checkers for free.

Our products are delivered from our factory in the Netherlands.

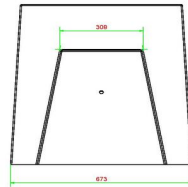
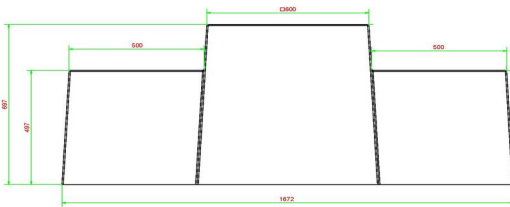
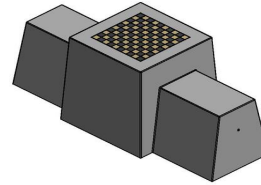
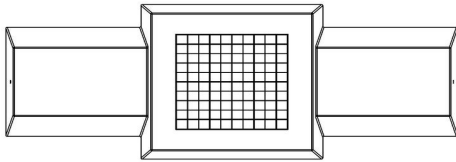

HeBlad
www.HeBlad.com
BB.CK
Gewicht ± 1140 KG.

Specifications Checkers/Drafts Bench, Natural Concrete

Product code	BB.CK	Height tabletop	70 cm
Colour	Natural concrete	Weight	1140 kg
Dimensions (L x W x H)	167 x 67 x 70 cm	Number of seats	2
Seat height	50 cm		

Related products



BB.CK.AB



BB.CH

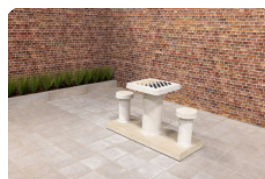

GT.CK.2



GT.CK.Pieces



GT.CH.4

Our products are delivered from our factory in the Netherlands.



Checkers/Drafts Bench, Anthracite-Concrete

Product code: BB.CK.AB

£ 2,425.00 excl. VAT
(£ 2,910.00 incl. VAT)

The game of checkers has never been so beautiful. This beautiful anthracite concrete checkers bench is made from one piece of concrete and the table top is inlaid with a checkers game. Two people can sit on either side of the checkers game and compete with each other there. The checker bank owes its robust character to its shape, but also to its colour. The concrete is entirely anthracite coloured, so if the bench unexpectedly suffers any damage, it will hardly be noticeable. Fortunately, the solid concrete is of such hardness that not many things influence the material. Vandalism and weather influences are not a factor for the anthracite concrete sheet pile.

The safety and sturdiness of the checker bank

Because the checker bank consists of one piece of concrete, this bank can very well be used multifunctionally on your site. In addition to its function as a game table or rest area, the bench can be used perfectly to protect your building. If you place the checker bank in front of a vulnerable part of your building, it makes a very good protection against ram raids for example. The placement also has a deterring effect.

Variations on the anthracite concrete checker bank

This robust anthracite concrete checker bank is available in different designs, but with the same base. The natural concrete checkers bench has a light appearance and, like its sibling, has an integrated checkers game in the table area. The bench can also be ordered as an anthracite concrete chess bench and natural concrete chess bench. The game of checkers has made way for a game of chess in these

3 April 2025 - Prices subject to change

Our products are delivered from our factory in the Netherlands.



correspondence address

HeBlad - UK

The Balance, 7th floor, Pinfold Street
S1 2GU Sheffield, South Yorkshire
T. 0114 352 0110
info@HeBlad.co.uk
www.HeBlad.co.uk

head office address

HeBlad BV

Diamantweg 22
NL - 5527 LC Hapert

tables.

Stability for the HeBlad banks

The fact that HeBlad products are specially designed and produced for years of outdoor use entails that they are strong and heavy. Not every surface is suitable for housing such weight. We have made a base plate for all HeBlad benches and banks for this purpose. For example, the anthracite concrete bench base fits perfectly with this anthracite concrete checker bench, the same colour and the same material. Please contact us if you have any questions about whether or not to use a base plate.

Our products are delivered from our factory in the Netherlands.

Registered under: HeBlad BV • HM Revenue and Customs • Ruby House 8 • Ruby Place • AB10 1ZP Aberdeen
VAT Number GB381060225 • EORI Number GB381060225000 • Commercial register (NL) 170 66 364
Rabobank De Kempen, Markt 7, 5531 BA Bladel (NL) • BIC RABONL2U • Branch code RABONL2UXXX • IBAN NL 20 RABO 0107530112 GBP

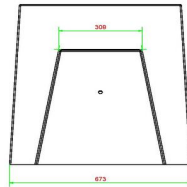
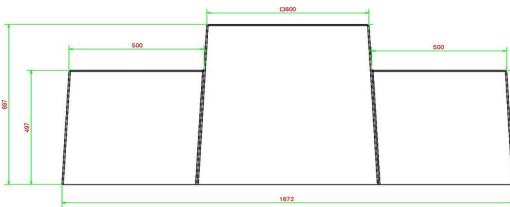
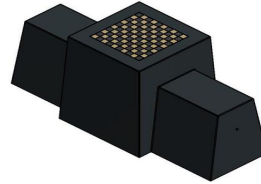
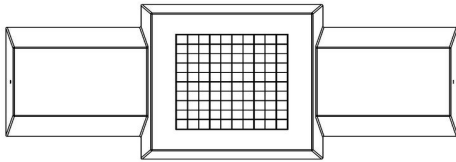

HeBlad
www.HeBlad.com
BB.CK.AB
Gewicht ± 1140 KG.

Specifications Checkers/Drafts Bench, Anthracite-Concrete

Product code	BB.CK.AB	Height tabletop	70 cm
Colour	Anthracite concrete	Weight	1140 kg
Dimensions (L x W x H)	167 x 67 x 70 cm	Number of seats	2
Seat height	50 cm		

Related products



BB.CK



BB.CH

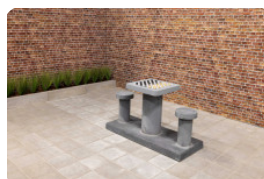

GT.CK.AB2



GT.CK.Pieces



GT.CK.AB4

Our products are delivered from our factory in the Netherlands.



Chess Table Natural Concrete (2P)

Product code: GT.CH.2

£ 3,100.00 excl. VAT
(£ 3,720.00 incl. VAT)

This concrete chess table for two people is made of Natural Concrete. The 'Concrete look' that results from this gives a beautiful appearance. The chess fields are made of natural stone and integrated into the concrete by us. Of course, this game table is also weatherproof. The base plate is 60 x 149 cm. By removing two rows of five paving stones from a square with average paving stones, a space of 60 x 150 cm is created. By placing the concrete chess table in this area, it will be completely integrated into your schoolyard.

If you want to place the table in a park, the required surface can be excavated so that the base plate can be placed there, at cutting height.

Concrete chess table for outdoor use

Chess is a strategic game and therefore very important that you think carefully about every step you take. What's better than playing chess in the open air! Fresh air ensures better concentration and, above all, it is also very healthy to spend time outdoors. The HeBlad tables do not take up much space and are completely installed by our professionals. In addition to the tables, the chess pieces are also available at HeBlad. When you order you will now receive 1 set of chess pieces for free. And of course our tables are so robust that they can withstand the UK weather.

Chessboard integrated in concrete

A chessboard is always square and consists of 64 square faces, 32 white and 32 black that alternate. The coloured square has been fully integrated into the concrete by HeBlad, so that it is vandalism and weather resistant.

3 April 2025 - Prices subject to change

Our products are delivered from our factory in the Netherlands.



correspondence address

HeBlad - UK

The Balance, 7th floor, Pinfold Street
S1 2GU Sheffield, South Yorkshire
T. 0114 352 0110
info@HeBlad.co.uk
www.HeBlad.co.uk

head office address

HeBlad BV

Diamantweg 22
NL - 5527 LC Hapert

Concrete chess table in the colour Natural

The HeBlad chess table consists of one main table with the white and black surfaces incorporated into it. In addition to the table, two chairs have also been made on the base plate. The entire table is made in natural concrete colour. This creates a peaceful appearance and is therefore ideal for a park or camping site.

About the game of chess

Chess is a popular strategic game that can keep you entertained for hours and consists of three phases, namely the beginning, the middle game and finally the end game. The game is played all over the world and the game has the same name in most languages. In the endgame the idea is that the path to the opponent's king is completely open. When this is the case, all that remains is to shout: checkmate!

Organize tournaments

In addition to our chess table, HeBlad also produces other game tables, such as checkers tables and ludo tables. Ideal for a fun and fanatical games tournament. Would you like more information about all our gaming tables? Take a look here or contact one of our employees. We are happy to help you and provide tailor-made advice.

*When you order one chess bench, you will receive 1 set of chess pieces.

Our products are delivered from our factory in the Netherlands.

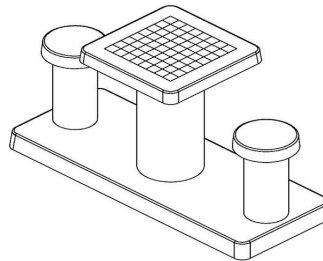
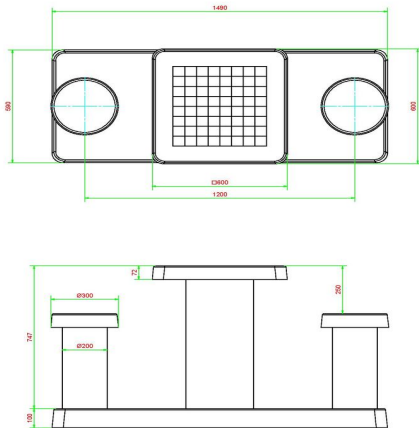

HeBlad
www.HeBlad.com
GT.CH.2
Gewicht ± 490 KG.

Specifications Chess Table Natural Concrete (2P)

Product code	GT.CH.2	Height tabletop	75 cm
Colour	Natural concrete	Seat height	50 cm
Dimensions (L x W x H)	149 x 60 x 85 cm	Dimensions base plate (L x W x H)	1490 x 60 x 10 cm
Dimensions tabletop (L x W)	60 x 60 cm	Weight	425 kg
Tabletop thickness	7 cm		

Related products



GT.CH.AB2



GT.CK.4



BB.CH



GT.CH.Pieces



PS.DLAB.GT.132

Our products are delivered from our factory in the Netherlands.



Chess Table Anthracite-Concrete (2P)

Product code: GT.CH.AB2

£ 3,200.00 excl. VAT
(£ 3,840.00 incl. VAT)

Decorate your outdoor space with this anthracite concrete chess table for two people. While enjoying the outdoors, you can rack your brains at this anthracite concrete chess table. A subtle, productive addition to your garden, park or grounds. By using anthracite concrete, this chess table has a beautiful slightly flaming effect incorporated.

Anthracite concrete chess table especially for outdoor use

HeBlad products are specifically made for outdoor use. This anthracite concrete chess table for 2 people is no exception. A beautiful slim, weather-resistant specimen that is a decoration for your outdoor space. Even the natural stone chess field is resistant to the weather. We have integrated the chess field into the concrete top plate, a wear-resistant solution and easy to maintain. The included wooden chess pieces can also take a beating.

Sturdy and stable gaming table for two people

This anthracite concrete chess table for 2 people has a slender appearance, but the weight of 425 kg shows that the chess table is strong and sturdy. With an ideal seat height of 50 cm and a playing surface that is 25 cm higher, this graceful product is wonderful to sit on and comfortable enough for hours of chess enjoyment. The playing top has dimensions of 60 x 60 cm and is 10 cm thick. Taking all dimensions and weights into account, it is logical that this concrete chess table is supplied on a base plate of 149 x 59 cm with a thickness of 10 cm. Everything is made from the same anthracite concrete.

The chess table can be placed in the lawn at cutting height, so that the bottom

3 April 2025 - Prices subject to change

Our products are delivered from our factory in the Netherlands.



correspondence address

HeBlad - UK

The Balance, 7th floor, Pinfold Street
S1 2GU Sheffield, South Yorkshire
T. 0114 352 0110
info@HeBlad.co.uk
www.HeBlad.co.uk

head office address

HeBlad BV

Diamantweg 22
NL - 5527 LC Hapert

plate integrates very subtly into the surface. This saves you from stubbing your toes and keeps mowing the lawn around the table easily. Placement can easily be done by removing tiles or digging up the grass or sand. Always contact HeBlad first. We are happy to inform you about the necessary preparations. And of course we are also happy to tell you about other products we have in the field of gaming tables and accessories.

* When ordering a chess table you will receive 1 set of chess pieces for free.

Our products are delivered from our factory in the Netherlands.

Registered under: HeBlad BV • HM Revenue and Customs • Ruby House 8 • Ruby Place • AB10 1ZP Aberdeen
VAT Number GB381060225 • EORI Number GB381060225000 • Commercial register (NL) 170 66 364
Rabobank De Kempen, Markt 7, 5531 BA Bladel (NL) • BIC RABONL2U • Branch code RABONL2UXXX • IBAN NL 20 RABO 0107530112 GBP

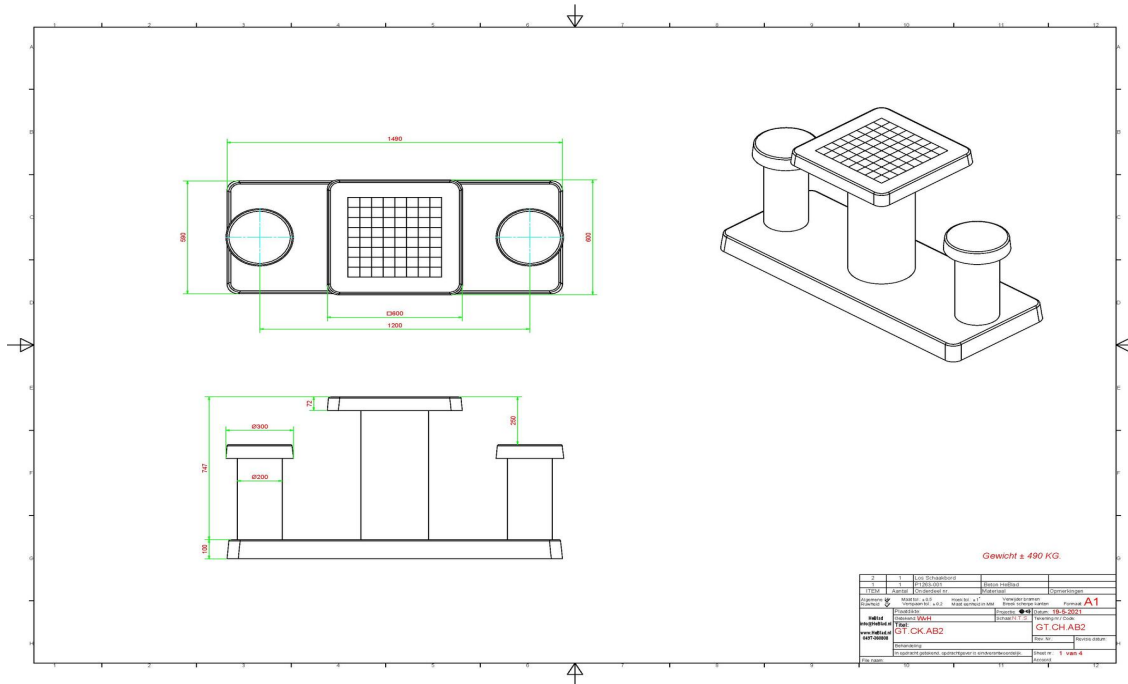

Specifications Chess Table Anthracite-Concrete (2P)

Product code	GT.CH.AB2	Height tabletop	75 cm
Colour	Anthracite concrete	Seat height	50 cm
Dimensions (L x W x H)	149 x 60 x 85 cm	Dimensions base plate (L x W x H)	149 x 60 x 10 cm
Dimensions tabletop (L x W)	60 x 60 cm	Weight	425 kg
Tabletop thickness	7 cm		

Related products



GT.CH.2



GT.CK.AB4



BB.CK.AB



GT.CH.Pieces



PS.DL.GT.132

Our products are delivered from our factory in the Netherlands.



Checkers/Drafts Table Natural Concrete (4P)

Product code: GT.CK.4

£ 3,350.00 excl. VAT
(£ 4,020.00 incl. VAT)

A real eye-catcher for your garden, schoolyard, park or campsite. The beautiful concrete checkers table in natural concrete is a pleasure to the eyes and is specifically made to either relax or to put your brain to work. When placing the checkers table, we like to let the table sink into the floor evenly, so that the base plate of the table is fully incorporated into the space. This makes the table one with the environment and ensures the correct depth in the grass at cutting height.

Concrete Checkers table with natural stone

The natural stone that we integrate into the concrete consists of marble and bluestone. This is what the 100 squares are made of, 50 white and 50 black squares, at the top of the checkers table. The concrete base plate measures 149 x 149 cm, the playing surface is measured at a height of 75 cm and you sit at a height of 50 cm from the ground. Let this natural concrete checkers table adorn your garden, square or park. Would you rather choose a different version? No problem! The same checkers table is also available in anthracite concrete colour.

Checkers tables and variants

Because the concrete checkers tables are made from one piece of concrete and they are resistant to all possible weather conditions, you will benefit from this checkers table for years to come. You can also maintain this natural concrete table truly natural through simple cleaning maintenance. Did you know that in addition to the natural and anthracite concrete version of the checkers table, you can also choose from a double checkers table or a checkers bench? You can also choose a chess or other game version. Perhaps you would like a combination of

3 April 2025 - Prices subject to change

Our products are delivered from our factory in the Netherlands.



correspondence address

HeBlad - UK

The Balance, 7th floor, Pinfold Street
S1 2GU Sheffield, South Yorkshire
T. 0114 352 0110
info@HeBlad.co.uk
www.HeBlad.co.uk

head office address

HeBlad BV

Diamantweg 22
NL - 5527 LC Hapert

various game tables in different colours? While reading the reviews from our customers, you might get some inspiration. Or maybe you'll even see products or projects on our news page that you would like to know more about...

Do you have any questions about the concrete checkers table?

Are you unsure about the space required for the concrete checkers table or about the colour that best suits your location? Please feel free to contact us, we will be happy to help you. You can also contact us with all your questions about the possibilities of combining checkers tables with, for example, foot volleyball tables, picnic tables or benches.

*When you order this checkers table you will receive 1 set of checkers for free.

Our products are delivered from our factory in the Netherlands.

Registered under: HeBlad BV • HM Revenue and Customs • Ruby House 8 • Ruby Place • AB10 1ZP Aberdeen
VAT Number GB381060225 • EORI Number GB381060225000 • Commercial register (NL) 170 66 364
Rabobank De Kempen, Markt 7, 5531 BA Bladel (NL) • BIC RABONL2U • Branch code RABONL2UXXX • IBAN NL 20 RABO 0107530112 GBP

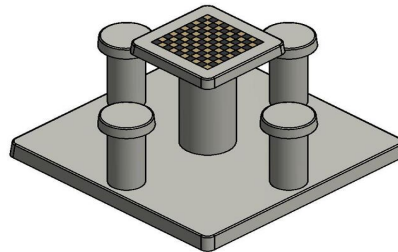
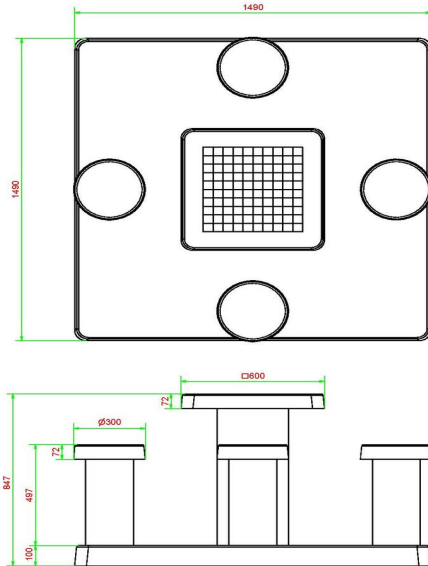

HeBlad
www.HeBlad.com
GT.CK.4

± 900 KG.

Specifications Checkers/Drafts Table Natural Concrete (4P)

Product code	GT.CK.4	Height tabletop	75 cm
Colour	Natural concrete	Seat height	50 cm
Dimensions (L x W x H)	149 x 149 x 85 cm	Dimensions base plate (L x W x H)	149 x 149 x 10 cm
Dimensions tabletop (L x W)	60 x 60 cm	Weight	900 kg
Tabletop thickness	7 cm		

Related products

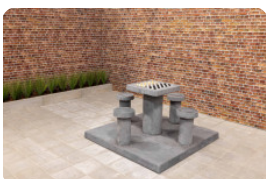

GT.CK.AB4



GT.CH.2



BB.CK



GT.CK.Pieces



PS.DLAB.GT.132

Our products are delivered from our factory in the Netherlands.



Checkers/Drafts Table Anthracite-Concrete (4P)

Product code: GT.CK.AB4

£ 3,450.00 excl. VAT
(£ 4,140.00 incl. VAT)

Graceful, multifunctional and super strong. This table is suitable for four people and can be used as a checkers game and as a table. Because the seats and table are very firmly attached to the base plate, this checkers table can flourish in any room. The table and seats have the ideal height for seating. The table top has an integrated checkers game with 50 white and 50 black game squares, and you will receive the accompanying set of checkers for free from us. And if you do the preliminary work for installation, we will ensure that the checkers table is placed in the right place free of charge.

Checkers table or checkers bench

Our checkers tables and chess tables are slim in appearance. For a more robust version, you can also opt for the anthracite concrete checker bank. This offers space for two people in the form of a bench. The table top is also equipped with a checkers game, and the whole bench is cast from one piece of concrete. The shape, material and colour make this checkerboard a unique, robust addition to your site.

Concrete checkers tables

Checkers tables are equipped with separate seats and a stand-alone table. Does the anthracite concrete colour not quite fit in with the environment where you want to place the table? Then perhaps the checkers table natural concrete 2 persons or the checkers table natural concrete 4 persons is the product you need. With the same sturdiness and strength as the anthracite concrete checkers bench, these checkers tables in natural concrete shine because of their light colour. The

3 April 2025 - Prices subject to change

Our products are delivered from our factory in the Netherlands.



correspondence address

HeBlad - UK

The Balance, 7th floor, Pinfold Street
S1 2GU Sheffield, South Yorkshire
T. 0114 352 0110
info@HeBlad.co.uk
www.HeBlad.co.uk

head office address

HeBlad BV

Diamantweg 22
NL - 5527 LC Hapert

bottom plates have also been adapted to these checkers tables.

Combine and vary with HeBlad

HeBlad stands for quality and years of enjoyment from beautiful outdoor products. It is therefore very possible to combine this checkers table with the game tables, picnic sets or concrete benches from HeBlad. The products are made of concrete and are not sensitive to severe weather conditions or vandalism. Are you curious about what HeBlad products can do for your location? Please contact us. We are always happy to help.

*When you order this checkers table you will receive 1 set of checkers for free.

Our products are delivered from our factory in the Netherlands.

Registered under: HeBlad BV • HM Revenue and Customs • Ruby House 8 • Ruby Place • AB10 1ZP Aberdeen
VAT Number GB381060225 • EORI Number GB381060225000 • Commercial register (NL) 170 66 364
Rabobank De Kempen, Markt 7, 5531 BA Bladel (NL) • BIC RABONL2U • Branch code RABONL2UXXX • IBAN NL 20 RABO 0107530112 GBP

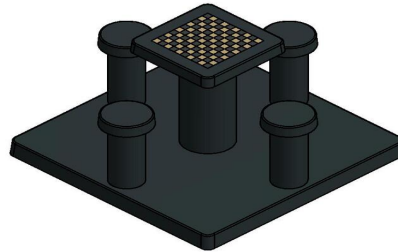
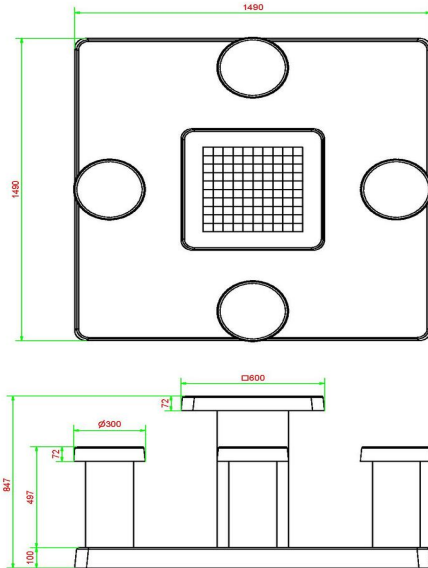

HeBlad
www.HeBlad.com
GT.CK.AB4
± 900 KG.

Specifications Checkers/Drafts Table Anthracite-Concrete (4P)

Product code	GT.CK.AB4	Height tabletop	75 cm
Colour	Anthracite concrete	Seat height	50 cm
Dimensions (L x W x H)	149 x 149 x 85 cm	Dimensions base plate (L x W x H)	149 x 149 x 10 cm
Dimensions tabletop (L x W)	60 x 60 cm	Weight	900 kg
Tabletop thickness	7 cm		

Related products



GT.CK.4



GT.CH.AB2



BB.CK.AB



GT.CK.Pieces



PS.DL.GT.132

Our products are delivered from our factory in the Netherlands.



Multi Gaming table (1-3-4) Standard

Product code: PS.ST.GT.134

£ 4,150.00 excl. VAT
(£ 4,980.00 incl. VAT)

We designed a multi-game table in the beautiful, calm colour of natural concrete, which contains no fewer than three board games. The natural stone game boards are integrated into the concrete table top. The entire multi-game table is cast from one piece of concrete, both the table and the seats.

Specifications multi-game table 1-3-4 natural concrete

What makes the multi-game table special? Firstly should be mentioned the sheer weight of the product - 950 kg. Its weight makes the table immovable for outsiders or malicious passers-by. The use of concrete ensures that it is resistant to vandalism, since the material is difficult to break. The materials used are also ideal for years of outdoor use. Easy to maintain the quality and the beautiful appearance. The dimensions of the multi-game table make it perfect for use as a regular picnic set. So if the table is not used as a game table, it will certainly not look out of place as a regular picnic set at your location. The games that this table offers include chess, ludo and backgammon. For other variants, take a look at our range of multi-game tables.

What requirements should a picnic set meet?

To use the multi-game table as a picnic table, it is essential that the seat height and the height of the table top are correct. Naturally we have taken this into account! With the perfect seat and table top height, this picnic set is a pleasure to sit on.

Where are HeBlad's multi-game tables located?

HeBlad products, including the multi-game table, can be found throughout Europe, for example at campsites, sports parks, school grounds, parks, public

3 April 2025 - Prices subject to change

Our products are delivered from our factory in the Netherlands.



correspondence address

HeBlad - UK

The Balance, 7th floor, Pinfold Street
S1 2GU Sheffield, South Yorkshire
T. 0114 352 0110
info@HeBlad.co.uk
www.HeBlad.co.uk

head office address

HeBlad BV

Diamantweg 22
NL - 5527 LC Hapert

parking facilities, and at rest areas during cycling and walking routes. But also in gardens, on business parks and on street corners. As long as the location meets the delivery conditions, a HeBlad product can be placed there.

Contact HeBlad

Are you interested in a multi-game table from HeBlad? Do you need any advice or explanation about the possibilities of the board games or do you have a different idea about the layout of the table? Please be sure to contact us, we will be happy to think along with you.

Please note: the base plate is optional and is not included as standard.

Our products are delivered from our factory in the Netherlands.

Registered under: HeBlad BV • HM Revenue and Customs • Ruby House 8 • Ruby Place • AB10 1ZP Aberdeen
VAT Number GB381060225 • EORI Number GB381060225000 • Commercial register (NL) 170 66 364
Rabobank De Kempen, Markt 7, 5531 BA Bladel (NL) • BIC RABONL2U • Branch code RABONL2UXXX • IBAN NL 20 RABO 0107530112 GBP

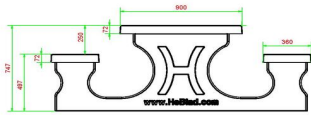
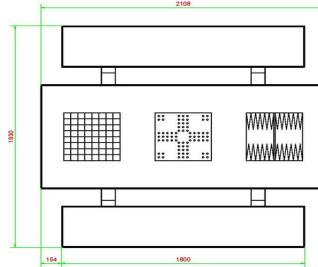
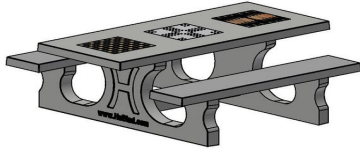

HeBlad
www.HeBlad.com
PS.ST.GT.134
± 950 KG.

Specifications Multi Gaming table (1-3-4) Standard

Product code	PS.ST.GT.134	Height tabletop	75 cm
Colour	Natural concrete	Seat height	50 cm
Dimensions (L x W x H)	210 x 193 x 75 cm	Material seat	Beton
Dimensions tabletop (L x W)	210 x 90 cm	Distance legs	111 cm (center to center)
Tabletop thickness	7 cm	Weight	950 kg

Related products



PS.DL.GT.134



PS.ST.GT.132

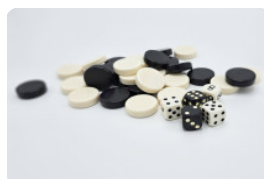

GT.BG.pieces



OP.PS

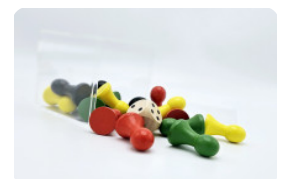

GT.LD.Pieces

Our products are delivered from our factory in the Netherlands.



Multi Gaming table (1-3-4) Standard Anthracite-concrete

Product code: PS.STAB.GT.134

This robust picnic set in the beautiful anthracite concrete colour guarantees endless fun and seating enjoyment. The integrated games of chess, ludo and backgammon offer everyone the opportunity to play a board game.

What do the numbers 1-3-4 stand for?

These numbers show the layout of the games that are incorporated into the table top of this anthracite concrete multi-game table. In this case it concerns a chess game, a ludo game and the backgammon game. You will receive the corresponding pawns and dice for free when you order the game table. The table is cast from one piece of concrete and the seat and table height are perfectly matched for a comfortable sitting position.

Installing and delivering the multi-game table

Because we are careful with our products, we make and supply the multi-game table ourselves. We have drawn up a number of delivery conditions for this, but you can always contact us to find out whether this table can be placed at your location. Taking into account your wishes, the users, the environment and the space you have.

Sturdy with a base plate

To make the multi-game table stable on a less stable or uneven surface, we have designed a matching base plate. You order this base plate separately from the game table, it is always optional and is not included in the price of the game table.

Combine the multi-game table with the concrete benches from HeBlad

Because the multi-game table has multiple functions, as both a game table and a

£ 4,300.00 excl. VAT
(£ 5,160.00 incl. VAT)

3 April 2025 - Prices subject to change

Our products are delivered from our factory in the Netherlands.



correspondence address

HeBlad - UK

The Balance, 7th floor, Pinfold Street
S1 2GU Sheffield, South Yorkshire
T. 0114 352 0110
info@HeBlad.co.uk
www.HeBlad.co.uk

head office address

HeBlad BV

Diamantweg 22
NL - 5527 LC Hapert

picnic set, this table can be perfectly combined with other HeBlad products. In the same beautiful anthracite concrete colour, concrete benches can be placed next to or near the multi-game table. These benches can be used as extra seating for visitors, but also as security for your site or building. These benches are by design also robust enough to serve as a barrier or as protection against ram raids. You are cordially invited to contact us for advice.

Please note: the base plate is optional and is not included as standard.

Our products are delivered from our factory in the Netherlands.

Registered under: HeBlad BV • HM Revenue and Customs • Ruby House 8 • Ruby Place • AB10 1ZP Aberdeen
VAT Number GB381060225 • EORI Number GB381060225000 • Commercial register (NL) 170 66 364
Rabobank De Kempen, Markt 7, 5531 BA Bladel (NL) • BIC RABONL2U • Branch code RABONL2UXXX • IBAN NL 20 RABO 0107530112 GBP

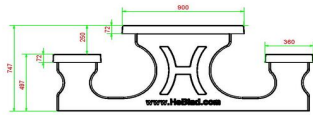
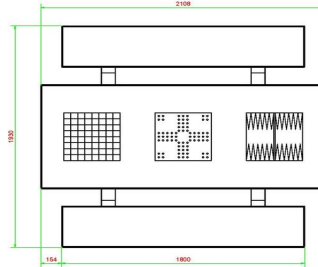

HeBlad
www.HeBlad.com
PS.STAB.GT.134
± 950 KG.

Specifications Multi Gaming table (1-3-4) Standard Anthracite-concrete

Product code	PS.STAB.GT.134	Height tabletop	75 cm
Colour	Anthracite concrete	Seat height	50 cm
Dimensions (L x W x H)	210 x 193 x 75 cm	Material seat	Beton
Dimensions tabletop (L x W)	210 x 90 cm	Distance legs	111 cm (center to center)
Tabletop thickness	7 cm	Weight	950 kg

Related products



PS.STAB.GT.111



PS.STAB.GT.132



GT.BG.pieces



OP.PS.AB



GT.LD.Pieces

Our products are delivered from our factory in the Netherlands.



Multi Gaming table (1-3-4) DeLuxe

Product code: PS.DL.GT.134

£ 4,300.00 excl. VAT
(£ 5,160.00 incl. VAT)

A luxurious games table that encourages outdoor play. With three different board games integrated into the tabletop, you have a beautiful picnic set that gives many a reason to enjoy the outdoors.

Which games to play at the multi-game table 1-3-4?

The multi-game table 1-3-4 means that this game table is equipped with a chess board (1), a ludo game (3) and a backgammon game board (4). HeBlad always supplies the corresponding playing pieces for free with the multi-game table. You can also order the multi-game table in other combinations. This also applies to the colour; the multi-game table is available in both natural concrete and anthracite concrete. The description 'Deluxe' of this table refers to the bamboo seats. These provide an extra comfortable seat, while the material is also weather resistant, just like the standard version.

How much space does the multi-game table 1-3-4 need?

The dimensions of the multi-game table 1-3-4 natural concrete are 210 x 193 x 75 cm and it weighs 780 kg. The tabletop is 210 x 90 cm and the seats have a seat height of 50 cm. Because the tabletop is placed at a height of 75 cm, the tabletop and the seats are the perfect distance apart for a comfortable sitting position. When installing the multi-game table, it is important to us that we can easily reach the site with our truck and crane. It is also important for you and your users that there is space around the gaming table, so that you can walk around the table.

The reliability of HeBlad

The way we make our products is the way we work. Secure, clear and with long term goals. You'll always receive sound advice, a transparent answer to questions

3 April 2025 - Prices subject to change

Our products are delivered from our factory in the Netherlands.



correspondence address

HeBlad - UK

The Balance, 7th floor, Pinfold Street
S1 2GU Sheffield, South Yorkshire
T. 0114 352 0110
info@HeBlad.co.uk
www.HeBlad.co.uk

head office address

HeBlad BV

Diamantweg 22
NL - 5527 LC Hapert

and the products we produce and supply are of extremely high quality. Our experience in making robust concrete benches, game tables and picnic sets helps satisfy customers. You are assured of the best products.

Please note: the base plate is optional and is not included as standard.

Our products are delivered from our factory in the Netherlands.

Registered under: HeBlad BV • HM Revenue and Customs • Ruby House 8 • Ruby Place • AB10 1ZP Aberdeen
VAT Number GB381060225 • EORI Number GB381060225000 • Commercial register (NL) 170 66 364
Rabobank De Kempen, Markt 7, 5531 BA Bladel (NL) • BIC RABONL2U • Branch code RABONL2UXXX • IBAN NL 20 RABO 0107530112 GBP

Specifications Multi Gaming table (1-3-4) DeLuxe

head office address

Product code	PS.DL.GT.134	Height tabletop	75 cm	HeBlad BV
Colour	Natural concrete	Seat height	50 cm	Diamantweg 22
Dimensions (L x W x H)	210 x 193 x 75 cm	Material seat	Bamboo	NL - 5527 LC Hapert
Dimensions tabletop (L x W)	210 x 90 cm	Distance legs	111 cm (center to center)	
Tabletop thickness	7 cm	Weight	780 kg	

Related products



PS.DL.GT.132



PS.DLAB.GT.134

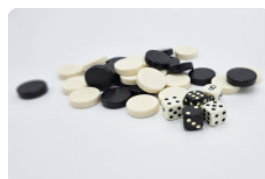

GT.BG.pieces



OP.PS



GT.LD.Pieces

Our products are delivered from our factory in the Netherlands.



Multi Gaming table (1-3-4) DeLuxe Anthracite-Concrete

Product code: PS.DLAB.GT.134

Are you having trouble choosing from HeBlad's wide range of gaming tables? Do you like board games and spending time outdoors? Then look no longer! The multi-game table (1-3-4) Deluxe anthracite concrete is exactly what you are looking for.

Why a HeBlad product?

Of course you can place a regular picnic set at your location. Beautiful and a true asset to your site. Specifically to increase the solidarity of visitors and to offer a challenge to users of the table, HeBlad has designed a wide range of game tables, ping pong tables, foot volleyball tables and table football tables. HeBlad products are made of robust concrete and specifically intended for installation in outdoor areas. You can find our products in both public spaces and private areas. Resistant to all weather influences and impervious to vandalism and theft.

Choose the multi-games table

Because we like to respond to the needs of our customers and we notice that making choices is not always easy, we have developed the multi-game table. Available in different variants, including this 1-3-4 model in anthracite concrete colour with bamboo seats. What does 1-3-4 mean? The numbers we use represent the games that are integrated into the table top. 1 stands for chess, 3 for ludo and 4 is backgammon. By choosing the multi-game table you are assured of a lot of gaming enjoyment for visitors, passers-by or avid board game players. But it is also a very comfortable and beautiful picnic table. With the perfect seat and table top height, you can sit comfortably, even when the board games are not being used. When you order a multi-game table, you will always receive the corresponding pawn sets and dice.

3 April 2025 - Prices subject to change

Our products are delivered from our factory in the Netherlands.



correspondence address

HeBlad - UK

The Balance, 7th floor, Pinfold Street
S1 2GU Sheffield, South Yorkshire
T. 0114 352 0110
info@HeBlad.co.uk
www.HeBlad.co.uk

head office address

HeBlad BV

Diamantweg 22
NL - 5527 LC Hapert

Contact HeBlad

Would you like to know more about the possible variants of the multi-game table or about the specifications of our products? Wondering whether your site is also suitable for HeBlad game tables? Contact us!

Please note: the base plate is optional and is not included as standard.

Our products are delivered from our factory in the Netherlands.

Registered under: HeBlad BV • HM Revenue and Customs • Ruby House 8 • Ruby Place • AB10 1ZP Aberdeen
VAT Number GB381060225 • EORI Number GB381060225000 • Commercial register (NL) 170 66 364
Rabobank De Kempen, Markt 7, 5531 BA Bladel (NL) • BIC RABONL2U • Branch code RABONL2UXXX • IBAN NL 20 RABO 0107530112 GBP

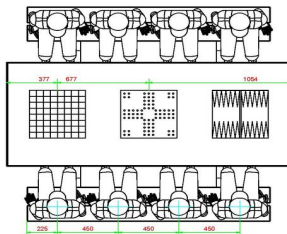
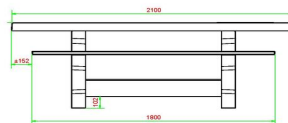
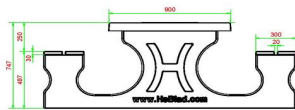
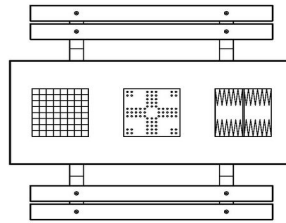
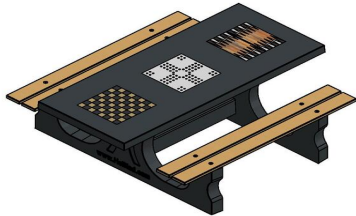

HeBlad
www.HeBlad.com
PS.DLAB.GT.134
± 780 KG.

Specifications Multi Gaming table (1-3-4) DeLuxe Anthracite-Concrete

Product code	PS.DLAB.GT.134	Height tabletop	75 cm
Colour	Anthracite concrete	Seat height	50 cm
Dimensions (L x W x H)	210 x 193 x 75 cm	Material seat	Bamboo
Dimensions tabletop (L x W)	210 x 90 cm	Distance legs	111 cm (center to center)
Tabletop thickness	7 cm	Weight	780 kg

Related products



PS.DL.GT.134



PS.ST.GT.134

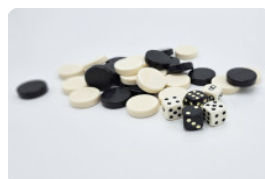

GT.BG.pieces



GT.LD.Pieces



GT.CH.Pieces

Our products are delivered from our factory in the Netherlands.



Concrete base plate for tennis table

Product code: OP.PP

£ 1,800.00 excl. VAT
(£ 2,160.00 incl. VAT)

Solve any lawn mowing problems in one go with this concrete base plate for the HeBlad ping pong table.

Also suitable for use under a foot volleyball table.

We have developed a concrete base plate with a size of 299 x 179 x 10 cm especially for our rectangular ping pong tables and the ping pong tables with rounded corners. The bottom plate keeps the space under the ping pong table free of weeds and makes the immediate area around the table very easy to keep clean. The base plate also provides the necessary stability. No more sagging gaming table, no more sloping table top: just gaming pleasure.

Supply and installation of concrete base plate for ping pong tables

We can only unload a concrete base plate and products with a base plate if the location is within crane reach, in this case within 5 meters. We can also only supply concrete for this base plate for our ping pong table if we can get close enough. For the exact conditions for delivery of the concrete base plate for ping pong tables, it is advisable to contact the professionals at HeBlad. Because this base plate is placed at ground level, it is important that the truck with loading and unloading crane can reach within 5 meters of the final location. Before the base plate can be laid, the sand bed is first adjusted to height. If the delivery conditions are met, delivery of the concrete base plate comes at no cost for you.

Various versions of concrete base plate for table tennis tables

Because we produce our ping pong tables in different colours, we do the same with the base plates. In addition to this natural concrete base plate, you also have

3 April 2025 - Prices subject to change

Our products are delivered from our factory in the Netherlands.



correspondence address

HeBlad - UK

The Balance, 7th floor, Pinfold Street
S1 2GU Sheffield, South Yorkshire
T. 0114 352 0110
info@HeBlad.co.uk
www.HeBlad.co.uk

head office address

HeBlad BV

Diamantweg 22
NL - 5527 LC Hapert

the option to choose the anthracite concrete base plate. With the same dimensions and specifications, made of coloured concrete. So combine the concrete base plate with other HeBlad game and play tables to your heart's content. Consider, for example, a ping-pong table. A table on which a game of chess, checkers and/or ludo can be played is also ideal.

This way you create an attractive scene in your public space. A place to be together for young and old. A social event where active games, rest and togetherness can be alternated.

Bottom plates will be placed at ground level. When the sand bed is ready at height, we can place the base plates in the right place with the crane, provided this is within 5 meters of our truck.

Our products are delivered from our factory in the Netherlands.

Registered under: HeBlad BV • HM Revenue and Customs • Ruby House 8 • Ruby Place • AB10 1ZP Aberdeen
VAT Number GB381060225 • EORI Number GB381060225000 • Commercial register (NL) 170 66 364
Rabobank De Kempen, Markt 7, 5531 BA Bladel (NL) • BIC RABONL2U • Branch code RABONL2UXXX • IBAN NL 20 RABO 0107530112 GBP

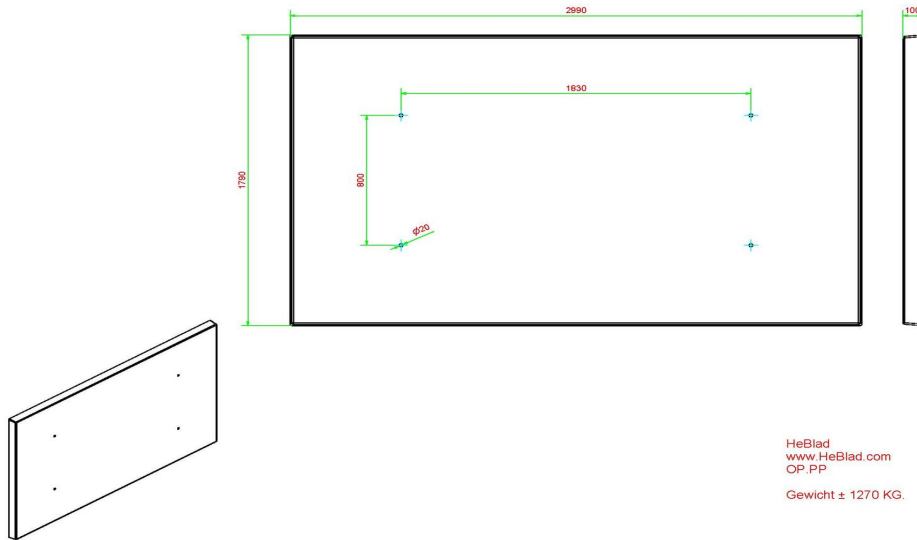

HeBlad
www.HeBlad.com
OP,PP
Gewicht ± 1270 KG.

Specifications Concrete base plate for tennis table

Product code	OP.PP	Finishing base plate	Smooth concrete
Colour	Natural concrete	lifting device	139 x 87 x 99 cm
Dimensions (L x W x H)	299 x 179 x 10 cm	preparation attachment	Holes for bolts M16
Weight	1270 kg		

Related products



PP.AR.BL



PP.AR.GR



PP.BL



PP.GR

Our products are delivered from our factory in the Netherlands.



Concrete base plate for tennis table Anthracite-Concrete

Product code: OP.PP.AB

HeBlad's ping pong tables are legendary, you can find them all over the world. From campsites in France and parks in Belgium to sports fields in the Netherlands, everyone has seen one. Due to their strength and robust appearance, the tables can be placed in any outdoor environment. Guaranteed years of fun for young and old. To keep the base of the ping pong table tidy and to position the table stably, we have designed a base plate especially for our ping pong tables.

Base plate for ping pong tables

With a size of 299 x 179 x 10 cm, you keep the space under the ping pong table rectangular and the ping pong table's rounded corners free of unwanted grass and weeds. The anthracite concrete colour gives a chic look and is made of the same material as HeBlad's other anthracite concrete products. This makes the base plate very suitable for placement under the anthracite concrete ping pong table and the rounded anthracite concrete ping pong table. Because of the size, you can also choose to use the anthracite concrete base plate as a contrast for the natural ping pong tables or the anthracite lacquered ping pong table. This base plate is also used under a HeBlad foot volleyball table.

Delivery of the base plate

The base plate is made from one piece and is supplied with a tap. Therefore, always check in advance whether your location meets the delivery conditions or contact us.

£ 1,900.00 excl. VAT
(£ 2,280.00 incl. VAT)

3 April 2025 - Prices subject to change

Our products are delivered from our factory in the Netherlands.



correspondence address

HeBlad - UK

The Balance, 7th floor, Pinfold Street
S1 2GU Sheffield, South Yorkshire
T. 0114 352 0110
info@HeBlad.co.uk
www.HeBlad.co.uk

head office address

HeBlad BV

Diamantweg 22
NL - 5527 LC Hapert

Base plate and benches.

The base plate provides stability to the products on a less flat or unstable surface. That is why our benches and other gaming tables can also be placed on the base plate. Combinations of different HeBlad products are certainly possible and will complement your site. We provide years of gaming fun and give spectators and passers-by a wonderful moment of rest.

Contact HeBlad

Do you also want to be sure of low-maintenance fun and also add an eye-catcher to your location? We are happy to think along with you about the possibilities and your wishes. Contact us and we will discuss the options.

Our products are delivered from our factory in the Netherlands.

Registered under: HeBlad BV • HM Revenue and Customs • Ruby House 8 • Ruby Place • AB10 1ZP Aberdeen
VAT Number GB381060225 • EORI Number GB381060225000 • Commercial register (NL) 170 66 364
Rabobank De Kempen, Markt 7, 5531 BA Bladel (NL) • BIC RABONL2U • Branch code RABONL2UXXX • IBAN NL 20 RABO 0107530112 GBP

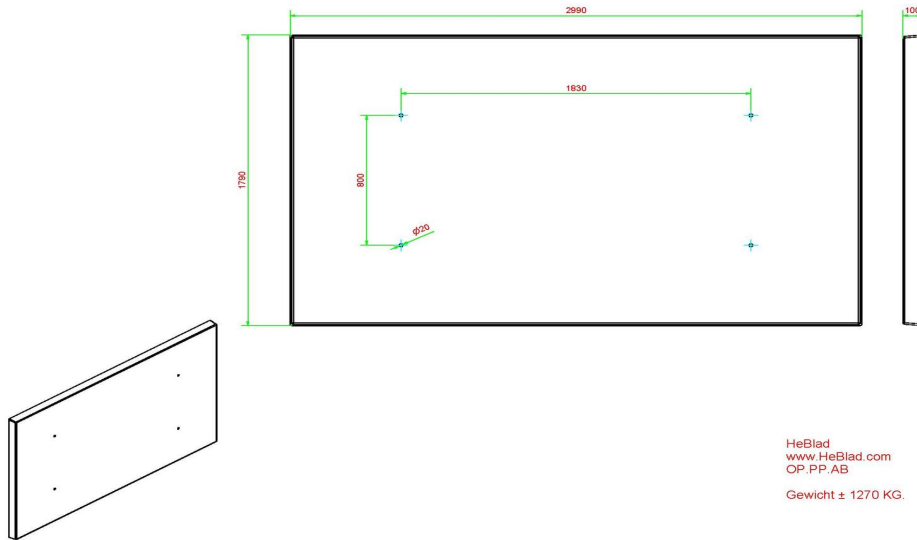

HeBlad
www.HeBlad.com
OP.PP.AB
Gewicht ± 1270 KG.

Specifications Concrete base plate for tennis table Anthracite-Concrete

Product code	OP.PP.AB	Finishing base plate	Smooth concrete
Colour	Anthracite concrete	lifting device	139 x 87 x 99 cm
Dimensions (L x W x H)	299 x 179 x 10 cm	preparation attachment	Holes for bolts M16
Weight	1270 kg		

Related products



OP.PP



OP.PS.AB



PP.AR.BL



PP.GR



PP.AR.AB

Our products are delivered from our factory in the Netherlands.



Bench DeLuxe Natural Concrete

Product code: BB.DL

£ 1,775.00 excl. VAT
(£ 2,130.00 incl. VAT)

A solid concrete bench in the DeLuxe version with a concrete seat, comfortable and appealing. The concrete bench is made of high-quality concrete and has a beautiful bamboo seating area. The robustness of the sturdy concrete and the refined bamboo seat make this DeLuxe concrete bench a perfect addition to your site.

Concrete bench with multiple functions

Use the DeLuxe concrete bench to protect your building. You can effortlessly create seats and protect your building against burglary and ram raids. You can easily place this concrete bench with a bamboo seat in front of vulnerable parts of your building, making vandalism almost impossible. With a weight of 700 kg, this DeLuxe concrete bench cannot be moved without large equipment after installation. Beautify your site with the DeLuxe concrete bench. The bamboo seat makes this DeLuxe concrete bench a chic way to receive visitors. Bamboo is weather resistant and soft on the seat. The seat is blind mounted, so it can withstand vandalism attempts.

Combine concrete bench with ping pong table

Do you already have a HeBlad gaming table? A ping pong table, foot volleyball table or table football table? Then this concrete bench with a bamboo seat fits in beautifully. With this concrete bench DeLuxe you give your game table a central point for visitors, a place of rest in combination with movement. Combinations with other HeBlad benches are also recommended, all made of sturdy concrete, safe and durable. Are you going for a calm appearance or do you like diversity?

3 April 2025 - Prices subject to change

Our products are delivered from our factory in the Netherlands.



correspondence address

HeBlad - UK

The Balance, 7th floor, Pinfold Street
S1 2GU Sheffield, South Yorkshire
T. 0114 352 0110
info@HeBlad.co.uk
www.HeBlad.co.uk

head office address

HeBlad BV

Diamantweg 22
NL - 5527 LC Hapert

Delivery concrete bench Deluxe with a Bamboo seat

We produce and deliver our products ourselves, free of charge throughout the Netherlands. Please feel free to contact us for delivery conditions. We will be happy to discuss with you how we can place the concrete bench with a bamboo seat on your site.

Discount when purchasing multiple HeBlad concrete benches

If you are considering ordering several DeLuxe concrete benches, we have a nice discount for you. You save 17% on the price from every 2nd product, a good discount for a great concrete bench. Order easily and quickly online or contact us and ask your questions.

Our products are delivered from our factory in the Netherlands.

Registered under: HeBlad BV • HM Revenue and Customs • Ruby House 8 • Ruby Place • AB10 1ZP Aberdeen
VAT Number GB381060225 • EORI Number GB381060225000 • Commercial register (NL) 170 66 364
Rabobank De Kempen, Markt 7, 5531 BA Bladel (NL) • BIC RABONL2U • Branch code RABONL2UXXX • IBAN NL 20 RABO 0107530112 GBP

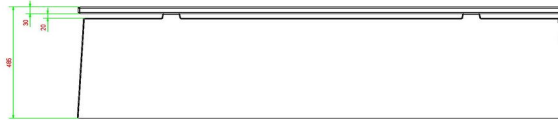
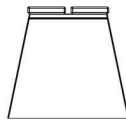
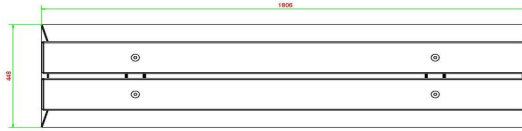
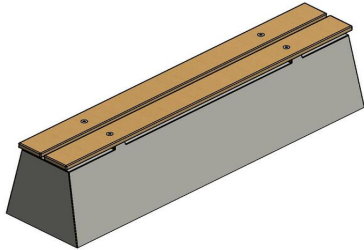

HeBlad
www.HeBlad.com
BB.DL
gewicht ± 700 KG.

Specifications Bench DeLuxe Natural Concrete

Product code	BB.DL	Seat height	50 cm
Colour	Natural concrete	Material seat	Bamboo
Dimensions (L x W x H)	180 x 45 x 50 cm	Number of seats	4
Dimensions seat	180 x 30 cm	Weight	700 kg

Related products



BB.DL.ML



PS.DL



PP.R.BL



HB.FB.A



OP.BB

Our products are delivered from our factory in the Netherlands.



Concrete Bench DeLuxe Anthracite

Product code: BB.DL.A

£ 1,825.00 excl. VAT
(£ 2,190.00 incl. VAT)

With a very subtle, but sleek appearance, this DeLuxe anthracite concrete bench with bamboo seat does not resemble concrete, but nothing could be further from the truth. The concrete bench is made from one piece of concrete, which makes it sturdy and weather-resistant. The smooth anthracite lacquer layer gives this concrete bench its modern look. The fact that the seat is mounted blindly also helps in its refinement. Chic, comfortable and solid seating are perfectly combined in this concrete bench.

The concrete bench deluxe anthracite with bamboo seat offers safety

The DeLuxe anthracite concrete bench with bamboo seat looks refined, but is not inferior in solidity to HeBlad's other benches. In addition to providing seating, this concrete bench is also ideal to use to demarcate an area or to place to protect a vulnerable part of your building against ram raids.

Combining is easy with the concrete bench deluxe anthracite with bamboo seat

The sleek design of the DeLuxe anthracite concrete bench with bamboo seat makes this bench easy to combine with other products specifically designed for the outdoors.

The HeBlad foot volleyball tables will look great when this concrete bench is placed next to them. Sports enthusiasts can rest on the concrete bench between games, fanatic supporters contribute to fun and turn your field into a beautiful eye-catcher.

Ask your questions to the professionals at Heblad

3 April 2025 - Prices subject to change

Our products are delivered from our factory in the Netherlands.



correspondence address

HeBlad - UK

The Balance, 7th floor, Pinfold Street
S1 2GU Sheffield, South Yorkshire
T. 0114 352 0110
info@HeBlad.co.uk
www.HeBlad.co.uk

head office address

HeBlad BV

Diamantweg 22
NL - 5527 LC Hapert

We understand that the thought of purchasing a concrete bench DeLuxe anthracite with bamboo seat may raise questions. That is why we are happy to assist you, please contact us by telephone or email and submit your questions to us. We can help you with product advice, explanation about the gaming tables, interesting discounts and delivery conditions. We also understand that you would like to take place on your concrete bench as quickly as possible. You can easily order online, we give a nice discount if you purchase two or more products. We'd love to hear from you!

Our products are delivered from our factory in the Netherlands.

Registered under: HeBlad BV • HM Revenue and Customs • Ruby House 8 • Ruby Place • AB10 1ZP Aberdeen
VAT Number GB381060225 • EORI Number GB381060225000 • Commercial register (NL) 170 66 364
Rabobank De Kempen, Markt 7, 5531 BA Bladel (NL) • BIC RABONL2U • Branch code RABONL2UXXX • IBAN NL 20 RABO 0107530112 GBP

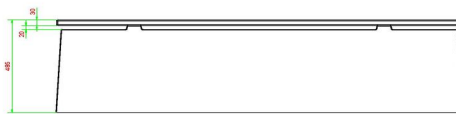
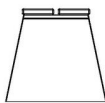
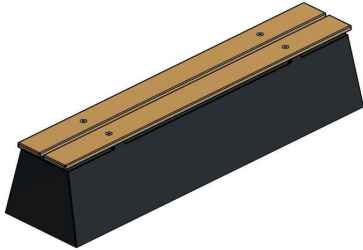

HeBlad
www.HeBlad.com
BB.DL.A

gewicht ± 700 KG.

Specifications Concrete Bench DeLuxe Anthracite

Product code	BB.DL.A	Seat height	50 cm
Colour	Anthracite lacquered, RAL 7016	Material seat	Bamboo
Dimensions (L x W x H)	180 x 45 x 50 cm	Number of seats	4
Dimensions seat	180 x 30 cm	Weight	700 kg

Related products



BB.DLA.ML



PS.DL.A

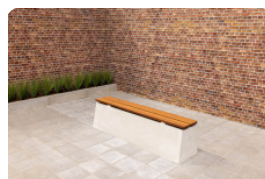

BB.DL



BB.ST.A



BB.DLA.OV

Our products are delivered from our factory in the Netherlands.



Bench DeLuxe Anthracite-Concrete

Product code: BB.DL.AB

£ 1,850.00 excl. VAT
(£ 2,220.00 incl. VAT)

A sturdy, robust concrete bench with a very refined bamboo seating area. The anthracite colour applies to the entire bench, because it is cast from anthracite coloured concrete. This gives the DeLuxe anthracite concrete bench that contemporary concrete look. The refinement of the concrete bench lies in the seat, which is made of bamboo. Bamboo, like concrete, is strong, solid and durable. So the bamboo top is the perfect complement to the concrete base.

Go for safety and comfort with the deluxe anthracite bench

The bamboo seat of the concrete bench guarantees a comfortable seat. The concrete of the bench also makes it possible to use the bench as a partition for a site or entrance, or as protection against burglary or vandalism. The DeLuxe anthracite concrete bench provides protection and safety. Do you think the concrete look does not suit your space? Then choose the same strength in the DeLuxe anthracite bench with bamboo seat. This bench is sleekly lacquered in anthracite colour. If you prefer a more natural look, then the natural concrete bench with bamboo seat is an easy choice.

Combine the deluxe anthracite concrete bench with a picnic set
All HeBlad products are made in-house and are often made of concrete. That is why the possibilities for combinations are endless, because many items can be placed nicely together without it looking messy. Our picnic sets are a wonderful example to use as an extension of the DeLuxe anthracite concrete bench. We have both the concrete benches and the picnic sets in various designs. Natural concrete, anthracite concrete or anthracite lacquered. But also with or without a bamboo seat. Tastes differ, and HeBlad offers something for everyone.

3 April 2025 - Prices subject to change

Our products are delivered from our factory in the Netherlands.



correspondence address

HeBlad - UK

The Balance, 7th floor, Pinfold Street
S1 2GU Sheffield, South Yorkshire
T. 0114 352 0110
info@HeBlad.co.uk
www.HeBlad.co.uk

head office address

HeBlad BV

Diamantweg 22
NL - 5527 LC Hapert

Ask your questions about the deluxe anthracite concrete bench
You can be assured of years of enjoyment from the DeLuxe anthracite concrete bench because of its solidity and weather resistance. Are you afraid that the concrete bench is not suitable for your site? It may be wise to use the base plate to place the DeLuxe anthracite concrete bench on for more stability. If you have any questions, please contact us, we will be happy to advise you.

Our products are delivered from our factory in the Netherlands.

Registered under: HeBlad BV • HM Revenue and Customs • Ruby House 8 • Ruby Place • AB10 1ZP Aberdeen
VAT Number GB381060225 • EORI Number GB381060225000 • Commercial register (NL) 170 66 364
Rabobank De Kempen, Markt 7, 5531 BA Bladel (NL) • BIC RABONL2U • Branch code RABONL2UXXX • IBAN NL 20 RABO 0107530112 GBP

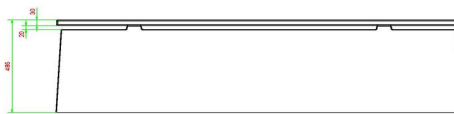
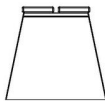
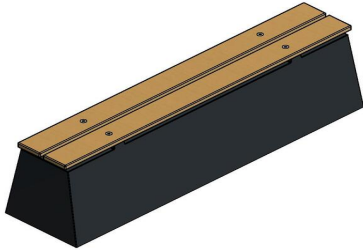

HeBlad
www.HeBlad.com
BB.DL.AB
gewicht ± 700 KG.

Specifications Bench DeLuxe Anthracite-Concrete

Product code	BB.DL.AB	Seat height	50 cm
Colour	Anthracite concrete	Material seat	Bamboo
Dimensions (L x W x H)	180 x 45 x 50 cm	Number of seats	4
Dimensions seat	180 x 30 cm	Weight	700 kg

Related products



BB.DL



BB.DL.A



BB.DLAB.ML



BB.ST.AB



BB.PB.OP

Our products are delivered from our factory in the Netherlands.



High Table Natural Concrete

Product code: HB.ST

£ 2,250.00 excl. VAT
(£ 2,700.00 incl. VAT)

This standing table is cast from one piece of concrete and is particularly strong and heavy. Blowing over, theft or vandalism are not things you'll have to worry about. It is an ideal piece of furniture for the schoolyard, at your catering facility, on your terrace, in the park or even in your garden. The top is the same size as the bottom. The table is sturdy, solid and also beautiful to look at. This concrete standing table will invite people everywhere outside to take a break and have something to eat, a drink or a chat.

The concrete standing table specifications

You have come to expect quality from us, and our standing table is no exception to this rule. It's evident from the specifications:

- Extra sturdy and solid: cast from one piece of concrete.
- Resistant to all weather conditions and easy to clean.
- Almost 1000 kilos heavy, so it cannot be blown over or stolen.
- Dimensions: 120x120x113 centimeters.
- A stylish table that will be used extensively in various outdoor situations.

Strong and impervious to theft

If you decide to order our concrete standing table, it is useful to be aware of the weight of the table. It is not without reason that we deliver the table ourselves. We use the truck's crane to put the standing table in place. This crane can bridge 5 meters. Once the table is in place, it is no longer able to be moved, even with a pallet truck. The advantage of this is that you do not have to worry about theft and that the table will not fall over or blow over, even in a storm. Once the table is in

3 April 2025 - Prices subject to change

Our products are delivered from our factory in the Netherlands.



correspondence address

HeBlad - UK

The Balance, 7th floor, Pinfold Street
S1 2GU Sheffield, South Yorkshire
T. 0114 352 0110
info@HeBlad.co.uk
www.HeBlad.co.uk

head office address

HeBlad BV

Diamantweg 22
NL - 5527 LC Hapert

place, it can remain in place for many years without any problems.

Order a concrete standing table

Are you interested in our standing table? Then ordering online is very easy. We will deliver these to you. Are you still in doubt or do you have other wishes? Please contact one of our expert employees. They are happy to help you and answer all questions. Even when it concerns one of our other products such as benches, game tables or picnic tables.

Our products are delivered from our factory in the Netherlands.

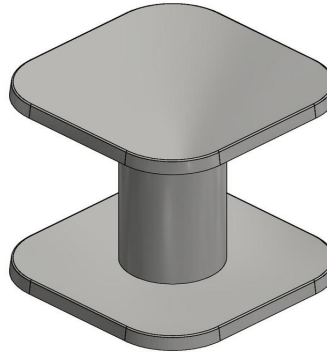
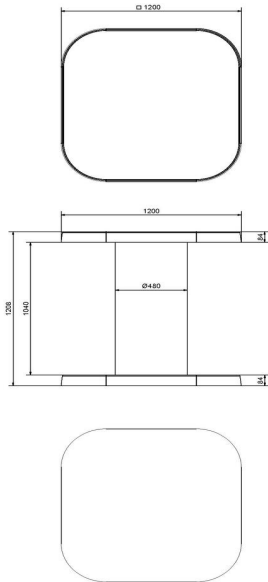

HeBlad
www.HeBlad.com
HB.ST
Gewicht ± 830 KG

Specifications High Table Natural Concrete

Product code	HB.ST	Height tabletop	113 cm
Colour	Natural concrete	Tabletop thickness	8,5 cm
Dimensions (L x W x H)	120 x 120 x 113 cm	Weight	985 kg
Dimensions tabletop (L x W)	120 x 120 cm		

Related products



HB.ST.A



HB.ST.AB

Our products are delivered from our factory in the Netherlands.



Concrete High Table Anthracite

Product code: HB.ST.A

£ 2,350.00 excl. VAT
(£ 2,820.00 incl. VAT)

Convenience and beauty come together in the anthracite high table. With a weight of 985 kg, this standing table is ideal for safe outdoor use. Think of terraces, parks, schoolyards and sports facilities. The concrete and the shape make the standing table solid, robust and resistant to vandalism and weather influences. The sleek anthracite lacquer layer makes maintenance very easy and retains its beautiful colour. With the table top at a height of 113 cm, it is wonderful to 'hang about', which offers an inviting and attractive appearance.

Place the anthracite standing table separately or on a base plate

The design of this anthracite high table has been extremely well thought out. Thanks to its weight, the table cannot be pushed over and can therefore be placed loosely in the room. The fixed base plate is designed with its width and thickness to provide the table with stability. If the surface is not suitable for placing the standing table, it is optional to use a separate base plate. With an additional base plate, the standing table has a larger support surface and the weight is distributed over a larger surface. This means that e.g. the table sinks less quickly on a soft surface.

The anthracite standing table and other HeBlad products

In addition to the anthracite standing table, HeBlad has a huge range of outdoor products. All these products can be combined with each other thanks to their simplistic design and unity of appearance. For example, the standing table is a fantastic addition to HeBlad's ping pong tables. Made from the same high-quality concrete with the same hardness and weather resistance. This also applies to the

3 April 2025 - Prices subject to change

Our products are delivered from our factory in the Netherlands.



correspondence address

HeBlad - UK

The Balance, 7th floor, Pinfold Street
S1 2GU Sheffield, South Yorkshire
T. 0114 352 0110
info@HeBlad.co.uk
www.HeBlad.co.uk

head office address

HeBlad BV

Diamantweg 22
NL - 5527 LC Hapert

benches and picnic sets. Or perhaps a combination with the natural concrete high table will make your site more beautiful.

Discover the possibilities at HeBlad

Due to the size of the high table, it is important to view the delivery conditions before installing the anthracite standing table, or to contact HeBlad. For the delivery of this standing table, we'll work directly from the truck, or with a crane from the truck. This crane has a reach of five meters. We are happy to discuss your options and provide you with information and advice about other products.

Our products are delivered from our factory in the Netherlands.

Registered under: HeBlad BV • HM Revenue and Customs • Ruby House 8 • Ruby Place • AB10 1ZP Aberdeen
VAT Number GB381060225 • EORI Number GB381060225000 • Commercial register (NL) 170 66 364
Rabobank De Kempen, Markt 7, 5531 BA Bladel (NL) • BIC RABONL2U • Branch code RABONL2UXXX • IBAN NL 20 RABO 0107530112 GBP

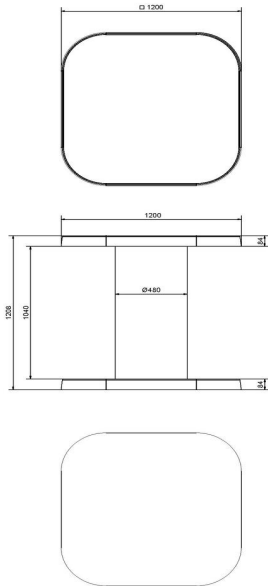

HeBlad
www.HeBlad.com
HB.ST.A
Gewicht ± 830 KG

Specifications Concrete High Table Anthracite

Product code	HB.ST.A	Height tabletop	113 cm
Colour	Anthracite lacquered, RAL 7016	Tabletop thickness	8.4 cm
Dimensions (L x W x H)	120 x 120 x 113 cm	Weight	985 kg
Dimensions tabletop (L x W)	120 x 120 cm		

Related products



HB.ST.AB



HB.ST

Our products are delivered from our factory in the Netherlands.



High Table Anthracite-Concrete

Product code: HB.ST.AB

£ 2,400.00 excl. VAT
(£ 2,880.00 incl. VAT)

Places where a standing table would be a good addition to the space, often lack strength or the table material cannot withstand the elements. At HeBlad we have the ideal solution for this: the anthracite concrete standing table. Thanks to its size and robustness, this standing table is difficult to move and is resistant to vandalism. The anthracite concrete is specifically intended for outdoor use. This way you can offer your guests the practical standing table for fun, you don't have to worry about your materials and it is unnecessary to protect the table against bad weather conditions.

Opt for ambiance and fun with the concrete standing table and ping pong table. If you have an area that is prone to vandalism, but you want to create a pleasant atmosphere, then this anthracite concrete standing table from HeBlad is a very good contestant. At sports parks, public playgrounds and in parks, the standing table provides a pleasant opportunity to bring parents together, for example, while the children exercise and play. By also placing the ping pong table or foot volleyball table, the children can play wonderful games while the parents or supervisors stand at the high table. HeBlad's ping pong tables are supplied with associated accessories. All HeBlad products are resistant to the most extreme weather conditions. This is due to the design and the high-quality material.

Other versions of the anthracite concrete standing table. Tastes differ, we know that at HeBlad. That is why we also have the anthracite concrete standing table in the versions anthracite lacquered standing table and natural concrete standing table. Combinations of different standing tables are of course also possible. This way, you can give your site a more playful atmosphere. When you order two or more standing tables you will receive a nice discount. For

3 April 2025 - Prices subject to change

Our products are delivered from our factory in the Netherlands.



correspondence address

HeBlad - UK

The Balance, 7th floor, Pinfold Street
S1 2GU Sheffield, South Yorkshire
T. 0114 352 0110
info@HeBlad.co.uk
www.HeBlad.co.uk

head office address

HeBlad BV

Diamantweg 22
NL - 5527 LC Hapert

delivery fees and delivery times, please consult our terms and conditions for delivery.

Terms of delivery for the anthracite concrete standing table

Because the anthracite concrete standing table is large and heavy, it is advisable to check the delivery conditions in advance or contact us about the installation options. Do you have questions or need advice? Please contact us, our professionals will be happy to help you.

Our products are delivered from our factory in the Netherlands.

Registered under: HeBlad BV • HM Revenue and Customs • Ruby House 8 • Ruby Place • AB10 1ZP Aberdeen
VAT Number GB381060225 • EORI Number GB381060225000 • Commercial register (NL) 170 66 364

Rabobank De Kempen, Markt 7, 5531 BA Bladel (NL) • BIC RABONL2U • Branch code RABONL2UXXX • IBAN NL 20 RABO 0107530112 GBP

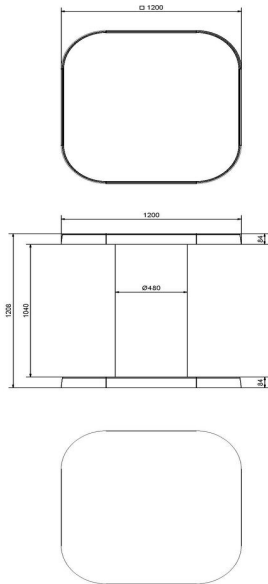

HeBlad
www.HeBlad.com
HB.ST.AB
Gewicht ± 830 KG

Specifications High Table Anthracite-Concrete

Product code	HB.ST.AB	Height tabletop	113 cm
Colour	Anthracite concrete	Tabletop thickness	8.4 cm
Dimensions (L x W x H)	120 x 120 x 113 cm	Weight	985 kg
Dimensions tabletop (L x W)	120 x 120 cm		

Related products



HB.ST.A



HB.ST

Our products are delivered from our factory in the Netherlands.



1 Liter Green paint

Product code: HB.Paint-6009

£ 60.00 excl. VAT
(£ 72.00 incl. VAT)

Who doesn't know them, the green ping pong tables from HeBlad? Within Europe they are found on many campsites, on sports fields, schoolyards and even in public parks. Made from one piece of super strong concrete and provided with a beautiful green paint layer with white painted lines and net. A real shame if the green colour has faded, pieces of paint have been knocked off or dirt prevails on the table. Fortunately, you do not have to replace the entire table. With a new lick of paint the table will be like new again. RAL 6009 is the exact colour green that we use to treat the tables.

Green paint and other colours

What colours of paint are available? In addition to the traditional green paint, we also offer the colours in which we supply our ping pong tables: blue and anthracite. But you can also easily order the white paint for the lines and the net online. Each colour consists of a pot of finish (the colour) and a pot of hardening agent (gloss), so that your paint is well protected against the elements. Your table will be as good as new again and can last for years to come.

Green paint and other accessories

In addition to the paint for the ping pong tables, we have also included all accessories for our table football tables in our range. This means that with a small adjustment or repair you can enjoy years of gaming fun again. The tables are of such high quality that they can easily survive the paint and accessories.

Help from and contact with HeBlad

Are you unsure about the paint you want to use or do you need advice with your order? Then be sure to contact us. Together we find the right answers and

3 April 2025 - Prices subject to change

Our products are delivered from our factory in the Netherlands.



correspondence address

HeBlad - UK

The Balance, 7th floor, Pinfold Street
S1 2GU Sheffield, South Yorkshire
T. 0114 352 0110
info@HeBlad.co.uk
www.HeBlad.co.uk

head office address

HeBlad BV

Diamantweg 22
NL - 5527 LC Hapert

articles.

Our products are delivered from our factory in the Netherlands.

Registered under: HeBlad BV • HM Revenue and Customs • Ruby House 8 • Ruby Place • AB10 1ZP Aberdeen
VAT Number GB381060225 • EORI Number GB381060225000 • Commercial register (NL) 170 66 364
Rabobank De Kempen, Markt 7, 5531 BA Bladel (NL) • BIC RABONL2U • Branch code RABONL2UXXX • IBAN NL 20 RABO 0107530112 GBP

Specifications 1 Liter Green paint

Product code HB.Paint-6009

head office address

HeBlad BV
Diamantweg 22
NL - 5527 LC Hapert

Related products



HB.Paint-7016



HB.Paint-5005



PP.AR.GR



PP.GR



PP.AR.LOW.GR

Our products are delivered from our factory in the Netherlands.



1 Liter Blue paint

Product code: HB.Paint-5005

£ 60.00 excl. VAT
(£ 72.00 incl. VAT)

Is it possible to paint game tables? In specific regard of the blue table tennis tables and the blue foot volleyball tables from HeBlad, 1 liter of blue paint (RAL 5005) can be ordered. With this you can easily touch up flaking or damaged parts of the blue ping pong table. Repairing is also much more sustainable than replacing the whole table. If you want to give the entire table a makeover, you can also order white paint to repaint the net and the white lines. With a new coat of paint, your ping pong table will be as good as new and can last for years.

Can a ping pong table be repaired?

The table tennis tables and other game tables from HeBlad are made to be used for many years and they are resistant to all weather conditions. Of course, our tables can also be damaged unexpectedly. Often it is not necessary to immediately replace the entire game table if it is damaged. Small irregularities can easily be touched up with the repair set.

HeBlad loves sustainability

HeBlad stands for sustainability. We produce robust products that last a long time. That is why we also offer the possibility to revive or repair our gaming tables if the table requires it. In this way, we ensure decades of gaming fun, without loss of comfort or beauty.

Do you want to know how to make your table as good as new, or which table fits best on your terrain? Then contact us, we are happy to help you on your way.

3 April 2025 - Prices subject to change

Our products are delivered from our factory in the Netherlands.

Specifications 1 Liter Blue paint

Product code HB.Paint-5005

head office address

HeBlad BV
Diamantweg 22
NL - 5527 LC Hapert

Related products



HB.Paint-7016



HB.Paint-6009



PP.AR.BL



PP.BL



PP.AR.LOW.BL

Our products are delivered from our factory in the Netherlands.



1 liter anthracite paint

Product code: HB.Paint-7016

£ 60.00 excl. VAT
(£ 72.00 incl. VAT)

Can an anthracite foot volley table or table tennis table be painted? The anthracite-coloured game tables from HeBlad are supplied in the colour RAL 7016. You can purchase this colour in a 1-litre can via our webshop. This way, you never have to look at a damaged game table, because updating and refreshing the anthracite game table is child's play. This also applies to the other HeBlad colours: green and blue. You can use the white paint to repaint the lines and the net. You will also receive a special hardener with the paint; this layer of lacquer protects your paintwork against discolouration and other damages caused by the weather.

Concrete table tennis table anthracite

How long does the anthracite table tennis table last? This game table, like all other HeBlad products, is specifically designed and manufactured to serve outdoors for years without affecting its appearance or usability. Because we also promote sustainability, the game tables with minor signs of wear or damage can easily be repaired or refreshed with paint or a repair kit.

Contact HeBlad

What damage can be repaired on the anthracite game tables? With a repair kit, you can quickly remove minor irregularities with the filler and you can easily refresh your table with the right paint. If you are unsure about the extent of your damage, please contact us. We can easily estimate how best to repair your damage.

3 April 2025 - Prices subject to change

Our products are delivered from our factory in the Netherlands.

Specifications 1 liter anthracite paint

Product code HB.Paint-7016

head office address

HeBlad BV
Diamantweg 22
NL - 5527 LC Hapert

Related products



HB.Paint-5005



HB.Paint-6009



HB.FB.A



PS.DLA



PS.DLA.OV

Our products are delivered from our factory in the Netherlands.



1 liter white paint

Product code: HB.Paint-white

£ 60.00 excl. VAT
(£ 72.00 incl. VAT)

Do you want to freshen up the lines and the net of your table tennis table or your foot volleyball table? This can easily be done with the paint that you order online. The white colour of the lines and the net can fade, get damaged or discolour. You can provide the entire table with a new layer of lacquer, but if the concrete table tennis table still looks very nice, you can also just renovate the net and white playing lines. That is why you can order the special white paint from us. This includes a special layer of lacquer to keep the white paint looking good and to protect it against dirt and weather influences.

Paint for ping pong tables

In addition to the white paint for the lines and the net, it is also possible to paint the entire table top of the ping pong tables. What colours are the ping pong tables available in? The colours you can choose from are: natural concrete, anthracite concrete, anthracite lacquered, blue and green. Paint is available for the blue, green and anthracite ping-pong tables. With a lick of paint and hardener, your robust ping-pong table will be brand new again and ready for years of fun.

Contact HeBlad about paint

If you want to give your ping-pong table a different colour than it originally is, we recommend that you contact us in advance. We can advise you on the amount of paint and the working method. You can also call or email us for questions about our other products, delivery or product specifications. Our team of specialists will be happy to help you.

3 April 2025 - Prices subject to change

Our products are delivered from our factory in the Netherlands.

Specifications 1 liter white paint

Product code HB.Paint-white

head office address

HeBlad BV
Diamantweg 22
NL - 5527 LC Hapert

Related products



HB.Paint-7016



HB.Paint-5005



PP.AR.A



PP.AR.BL



PP.AR.GR

Our products are delivered from our factory in the Netherlands.



Concrete Ping-pong table green, round

Product code: PP.R.GR

£ 3,550.00 excl. VAT
(£ 4,260.00 incl. VAT)

How much space does a table tennis table take up?

With a diameter of 260 cm, this round table tennis table is larger than a classic, rectangular table. Heblad's green, round table tennis table is substantial in diameter as well as in possibilities, opportunities, and in strength. Because of its shape, the playing possibilities on and around this table tennis table are endless.

How is a table tennis table made?

All Heblad table tennis tables are cast from one piece of high quality concrete, which means that the tables have a very long lifespan and are easy to maintain, while the table is left outside all year round. The table top of this round version is finished with a green two-component lacquer, and the colour white is used for the center line and net. This colour combination gives a fresh and recognizable appearance. If the green colour does not quite fit in with the environment, you can also choose the round blue ping pong table, round anthracite concrete ping pong table, round natural concrete or round anthracite.

Where are ping pong tables located?

A round ping-pong table is often the gathering place on a schoolyard, at a campsite, at a sports club or in a courtyard. To ensure that this meeting place can continue to serve as the place to meet each other and as an outdoor exercise stimulator, the specific choice of concrete is a logical one. Heblad tables are cast from one piece of concrete and equipped with top and bottom reinforcement. This makes the tables incredibly sturdy, and very easy to clean, which also improves its lifespan.

3 April 2025 - Prices subject to change

Our products are delivered from our factory in the Netherlands.



correspondence address

HeBlad - UK

The Balance, 7th floor, Pinfold Street
S1 2GU Sheffield, South Yorkshire
T. 0114 352 0110
info@HeBlad.co.uk
www.HeBlad.co.uk

head office address

HeBlad BV

Diamantweg 22
NL - 5527 LC Hapert

Tips for combining table tennis tables

Exercise is good for young and old! To turn the round table tennis table into a meeting place that encourages sports, placing extra tables or benches is the perfect addition. All our products are made of concrete and are intended for the outdoors. So feel free to place benches near the ping-pong table or add a picnic table. The table tennis game remains fun to play and watch. Introduce everyone to the game of ping pong and discover that exercise is fun.

Contact Heblad

We are happy to help you, please feel free to contact us. You can easily order your ping pong table, benches or other game tables on the website.

** When purchasing a Heblad ping pong table, a set of bats (4 bats and 2 balls) is included for free.

Our products are delivered from our factory in the Netherlands.

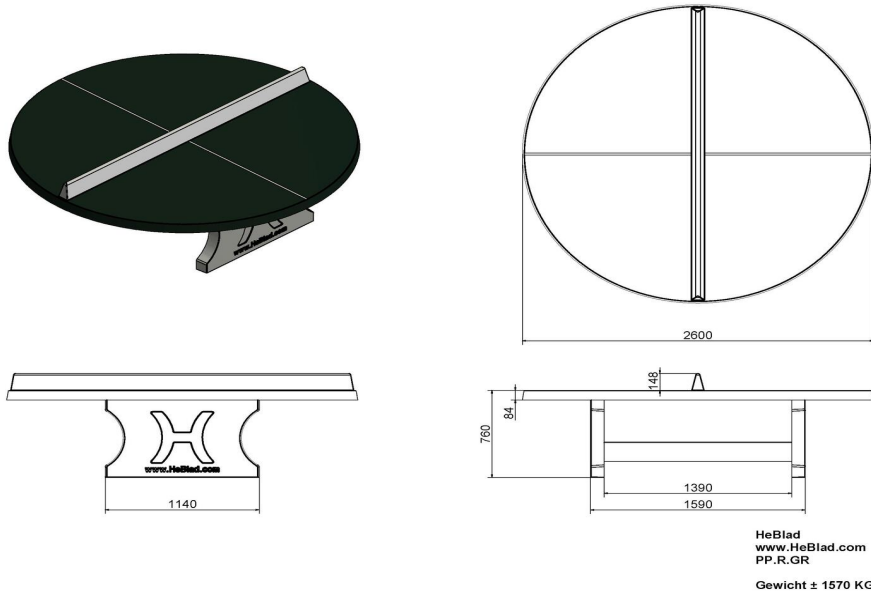

Specifications Concrete Ping-pong table green, round

Product code	PP.R.GR	Height tabletop	76 cm
Colour	Green - RAL 6009	Height of the net	14,75 cm
Dimension playing surface (L x W)	∅ 260 cm	Weight	1570 kg
Dimensions bottom of playing surface	∅ 264 cm	Distance legs	149 cm (center to center)
Tabletop thickness	8,4 cm		

Related products



PP.AR.BL



PP.NT



B.DS.SP



OP.PP



B.S1

Our products are delivered from our factory in the Netherlands.



Concrete Ping-pong table blue, round

Product code: PP.R.BL

£ 3,550.00 excl. VAT
(£ 4,260.00 incl. VAT)

Where are ping pong tables located? A beautiful, large, round concrete ping-pong table is a striking showpiece on the schoolyard, in a park or on a sports field that young and old will enjoy for years to come. Children like to gather where there is a round ping-pong table. They meet friends and when they come together they are ingenious in coming up with new ball games on this table. With a ping-pong table you encourage visitors to stay active and play outside, together.

The quality of the round concrete table tennis table

What is the quality of Heblad's round concrete ping pong tables? Just like our other table tennis tables, park benches, foot volleyball tables and game tables, this round concrete ping pong table is also made from one piece of concrete, with top and bottom reinforcement. This means that we guarantee that you can enjoy your round concrete ping pong table for years to come. The weight makes theft impossible and the material is scratch and weather resistant.

What games can be played on a round ping pong table?

The round shape of this table requires creativity. The game 'around the table' is of course very applicable here. Multiple players can also play at the table at the same time and the game possibilities are endless.

Different variants of ping pong tables

3 April 2025 - Prices subject to change

Our products are delivered from our factory in the Netherlands.



correspondence address

HeBlad - UK

The Balance, 7th floor, Pinfold Street
S1 2GU Sheffield, South Yorkshire
T. 0114 352 0110
info@HeBlad.co.uk
www.HeBlad.co.uk

head office address

HeBlad BV

Diamantweg 22
NL - 5527 LC Hapert

This round concrete ping pong table is painted blue, but the round concrete ping pong table is also available in other colours; lacquered green, anthracite concrete, natural concrete and anthracite. The concrete ping pong tables are also available in a rectangular shape and a rectangular shape with rounded corners. Would you prefer a variation on the ping pong table? Then take a look at the foot volleyball table.

Benches at the concrete table tennis table

You can easily combine the concrete ping pong table with a concrete bench or with a concrete picnic table. This creates even more social interaction, wonderfully outdoors. The more people continue to watch the game, the more people become active themselves. After all, the game is and remains infectious.

Interested in the round concrete table tennis table?

Are you interested in this round concrete ping pong table from HeBlad? Then easily order a ping pong table on our website. Do you have any questions about the concrete ping pong table or another product? Please view our frequently asked questions page or feel free to contact us. We are happy to help you!

** When purchasing a Heblad ping pong table, a set of bats (4 bats and 2 balls) is included for free.

Our products are delivered from our factory in the Netherlands.

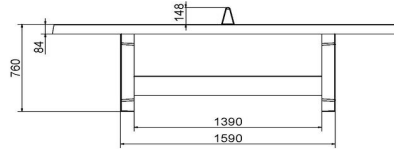
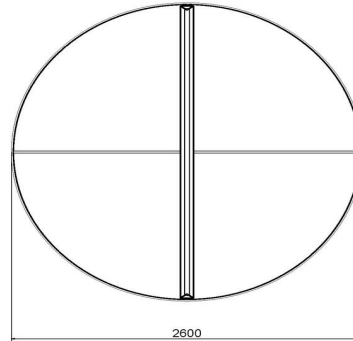
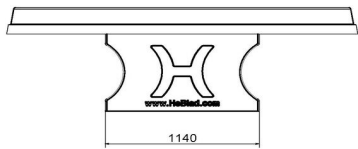
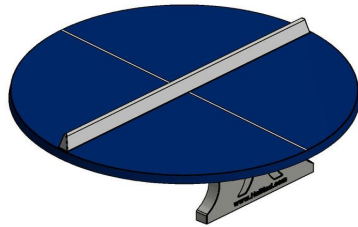

HeBlad
www.HeBlad.com
PP.R.BL
Gewicht ± 1570 KG

Specifications Concrete Ping-pong table blue, round

Product code	PP.R.BL	Height tabletop	76 cm
Colour	Blue - RAL 5005	Height of the net	14,75 cm
Dimension playing surface (L x W)	∅ 260 cm	Weight	1570 kg
Dimensions bottom of playing surface	∅ 264 cm	Distance legs	149 cm (center to center)
Tabletop thickness	8,4 cm		

Related products



PP.AR.GR



PP.NT



B.DS10



OP.PP

Our products are delivered from our factory in the Netherlands.



Round Ping-Pong table Anthracite

Product code: PP.R.A

£ 3,550.00 excl. VAT
(£ 4,260.00 incl. VAT)

Playing table tennis has never been so challenging. A round table offers countless gaming options. The regular game of table tennis becomes more challenging with this new design, but what about the game 'around the table'? The table tennis table round anthracite is cast from one piece of reinforced concrete. The anthracite colour of the table top and the white colour of the lines and net are free of peeling because of the two-component paint. This varnish is weather resistant, easy to clean and easy to maintain. A robust table tennis table with a beautiful round shape and sleek paintwork.

Concrete table tennis table with or without base plate

We supply our concrete ping pong table without a concrete base plate. However, in some cases it can be very practical to place our game and gaming tables on a concrete base plate. This way you can ensure that the table is stable, especially on soft grounds like grass. A concrete base is also easier to keep clean than a lawn, and unwanted weeds stand no chance to grow underneath your table, a space that is hard to maintain.

The concrete base plate is available in different colours. This way, the base plate fits well with the chosen ping pong table and any other game tables.

Table tennis tables supply

At Heblad, we deliver our products ourselves with our own truck, directly from our factory. We deliver with a loading/unloading crane on a 14 meter long truck. So there must be enough space taken into account for the installation of your table. The crane has a reach of up to 5 meters. Individual game tables can then be

3 April 2025 - Prices subject to change

Our products are delivered from our factory in the Netherlands.



correspondence address

HeBlad - UK
The Balance, 7th floor, Pinfold Street
S1 2GU Sheffield, South Yorkshire
T. 0114 352 0110
info@HeBlad.co.uk
www.HeBlad.co.uk

head office address

HeBlad BV
Diamantweg 22
NL - 5527 LC Hapert

moved with a pallet truck. Please note: 1 person must be present to help, this way we can ensure the correct placement of the table.

Are you also ordering a base plate? We can no longer move this manually with a pallet truck. We can only supply a concrete base plate and products with a (fixed) base plate within 5 meters of the truck. You then have to take care of the installation yourself. Please read our delivery conditions carefully and contact us if you have any doubts or questions.

Table tennis table round anthracite or natural

The round table tennis table is also available in the colours natural concrete, anthracite concrete, green and blue. Except for the difference in colour, these tables have the same high quality specifications. It's just a matter of taste and placement which colour is best for your property. Do you want the table tennis table to stand out in the area or do you prefer a quieter view? If you choose multiple table tennis tables, regardless of colour, you can count on a nice discount.

Contact Heblad

Ask all your questions about the product specifications of the table tennis tables or the options that Heblad has for your location. It is advisable to contact us, especially if you have questions about the delivery conditions or are unsure whether the location is sufficiently accessible. We are happy to think along with you and help you further.

Our products are delivered from our factory in the Netherlands.

Registered under: HeBlad BV • HM Revenue and Customs • Ruby House 8 • Ruby Place • AB10 1ZP Aberdeen
VAT Number GB381060225 • EORI Number GB381060225000 • Commercial register (NL) 170 66 364
Rabobank De Kempen, Markt 7, 5531 BA Bladel (NL) • BIC RABONL2U • Branch code RABONL2UXXX • IBAN NL 20 RABO 0107530112 GBP

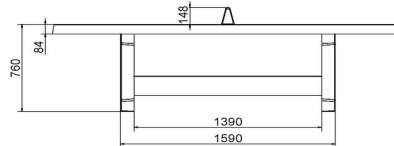
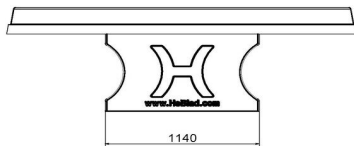
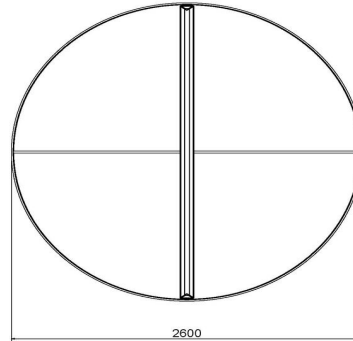
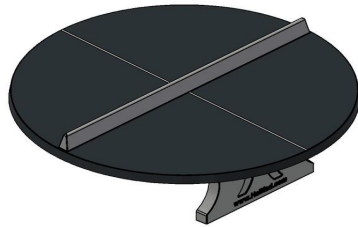

HeBlad
www.HeBlad.com
PP.R.A
Gewicht ± 1570 KG

Specifications Round Ping-Pong table Anthracite

Product code	PP.R.A	Height tabletop	76 cm
Colour	Anthracite - RAL 7016	Height of the net	14,75 cm
Dimension playing surface (L x W)	∅ 260 cm	Weight	1570 kg
Dimensions bottom of playing surface	∅ 264 cm	Distance legs	149 cm (center to center)
Tabletop thickness	8,4 cm		

Related products



PP.R.BL



PP.R.GR



B.DS10



PS.ST.GT.132



B.DS.SP

Our products are delivered from our factory in the Netherlands.



Round Ping-Pong table Anthracite-Concrete

Product code: PP.R.AB

£ 3,750.00 excl. VAT
(£ 4,500.00 incl. VAT)

The round concrete table tennis table is a nice addition to any schoolyard, playground or park. By placing this table tennis table in places where there are many young people, you encourage them to do more outdoor activities, such as table tennis! With this round ping-pong table, several people can easily play together at the same time. For endless fun!

Quality of the concrete ping pong tables

This round concrete table tennis table, like all other HeBlad game and gaming tables, is cast from one piece of concrete. This means that the round concrete table tennis table consists of one piece of concrete. The concrete is of high quality, as you have come to expect of us. This high-quality product is so strong and robust that it does not invite vandalism. This means you can enjoy table tennis with the HeBlad concrete ping pong tables for years to come!

What types of table tennis tables are available?

This round concrete table tennis table is also available in other versions: in the colours green, blue, anthracite or natural concrete. You can also obtain the concrete table tennis tables in other shapes: in the original rectangular shape and the rectangular shape with rounded corners.

Concrete base plate

3 April 2025 - Prices subject to change

Our products are delivered from our factory in the Netherlands.



correspondence address

HeBlad - UK

The Balance, 7th floor, Pinfold Street
S1 2GU Sheffield, South Yorkshire
T. 0114 352 0110
info@HeBlad.co.uk
www.HeBlad.co.uk

head office address

HeBlad BV

Diamantweg 22
NL - 5527 LC Hapert

Is a concrete base plate necessary for a table tennis table? The concrete base plate that comes with this round concrete table tennis table ensures that you will not be bothered by grass or mud under your table tennis table. This significantly reduces the risk of slipping while using the table tennis table. Moreover, this makes maintenance a lot easier and the table is even more stable. The bottom plate is optional for every game table. The base plate can be ordered separately and your site must meet a number of conditions. Always contact us to discuss this.

Combinations with concrete table tennis table

Make your park, playground or accommodation look even more inviting by combining our products. For example, you can place a concrete bench next to this round concrete table tennis table. Or a concrete picnic set. This allows young people to rest for a while after using the round concrete table tennis table and possibly have lunch. This provides additional encouragement for outdoor activities among young people.

Finally

Do you have any questions about the round concrete table tennis table or another product? Contact us, we are happy to help you!

** When purchasing a HeBlad ping pong table, a set of bats (4 bats and 2 balls) is included for free.

Our products are delivered from our factory in the Netherlands.

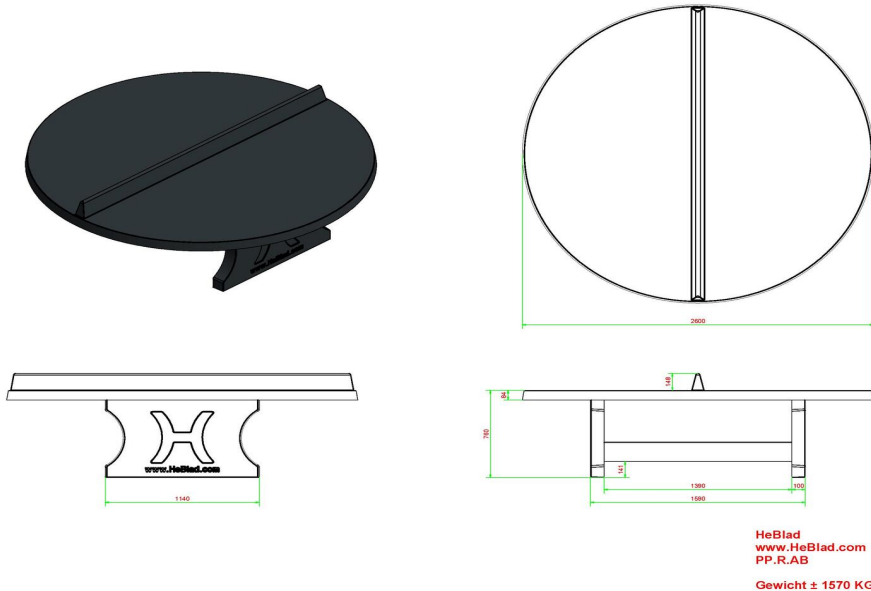

Specifications Round Ping-Pong table Anthracite-Concrete

Product code	PP.R.AB	Height tabletop	76 cm
Colour	Anthracite concrete	Height of the net	14,75 cm
Dimension playing surface (L x W)	ø 260 cm	Weight	1570 kg
Dimensions bottom of playing surface	ø 264 cm	Distance legs	149 cm (center to center)
Tabletop thickness	8,4 cm		

Related products



VV.AB



PP.AR.GR



PP.BL



PP.R.NT



B.DS.SP

Our products are delivered from our factory in the Netherlands.



Round Ping-pong table in Natural Concrete

Product code: PP.R.NT

£ 3,500.00 excl. VAT
(£ 4,200.00 incl. VAT)

The round ping pong tables are ideal for playing a game with several people at the same time. With a diameter of 260 cm, this table tennis table is large enough and therefore very suitable for a group of people. For this reason, the round table tennis table is a very popular product at HeBlad. Young people can enjoy themselves for hours on end and oftentimes come up with other fun games to play on this concrete ping pong table. The table also serves as a gathering place for groups of people.

How much space is needed for a table tennis table? This round version with a diameter of 260 cm naturally requires extra space to walk around it and move around the table. However, unlike what you might expect, a round table tennis table requires slightly less space than a standard ping pong table.

How is a table tennis table made?

Our robust table tennis table is produced from one piece of concrete, so nothing needs to be assembled together. This makes the table very strong and therefore more resistant to vandalism. The concrete used to make the tables is of high quality, as you have come to expect from us. This variant table tennis table is light in colour. The material is purely of natural origin and not processed. The table is particularly well suited for a quieter environment, such as in the woods. Would you prefer to see the ping pong table in another colour? Take a look, for example, at the green and blue versions of the concrete ping pong table. Would you rather not have a round table? No problem. We also produce ping pong tables with regular or rounded corners.

3 April 2025 - Prices subject to change

Our products are delivered from our factory in the Netherlands.



correspondence address

HeBlad - UK

The Balance, 7th floor, Pinfold Street
S1 2GU Sheffield, South Yorkshire
T. 0114 352 0110
info@HeBlad.co.uk
www.HeBlad.co.uk

head office address

HeBlad BV

Diamantweg 22
NL - 5527 LC Hapert

Why a base plate?

Combine the round, concrete ping pong table with a sturdy base plate. The base plate reduces the risk of slipping and also makes maintenance a lot easier. This means you do not have to mow under the table and no weeds can grow there. Our base plates are available in the colours natural concrete or anthracite concrete. Bottom plates are always optional and must be ordered separately, they are not included in the price of the game table.

Table tennis table in natural colour

The colour of this round ping pong table is natural. The table is made of natural concrete and has not subsequently been treated with a lacquer layer. The simplicity of this table makes it beautiful. The table can be combined well with our park benches. These are also available in natural concrete.

Want to know more? Please feel free to contact us and one of our employees will be happy to help you.

** When purchasing a HeBlad ping pong table, a set of bats (4 bats and 2 balls) is included for free.

Our products are delivered from our factory in the Netherlands.

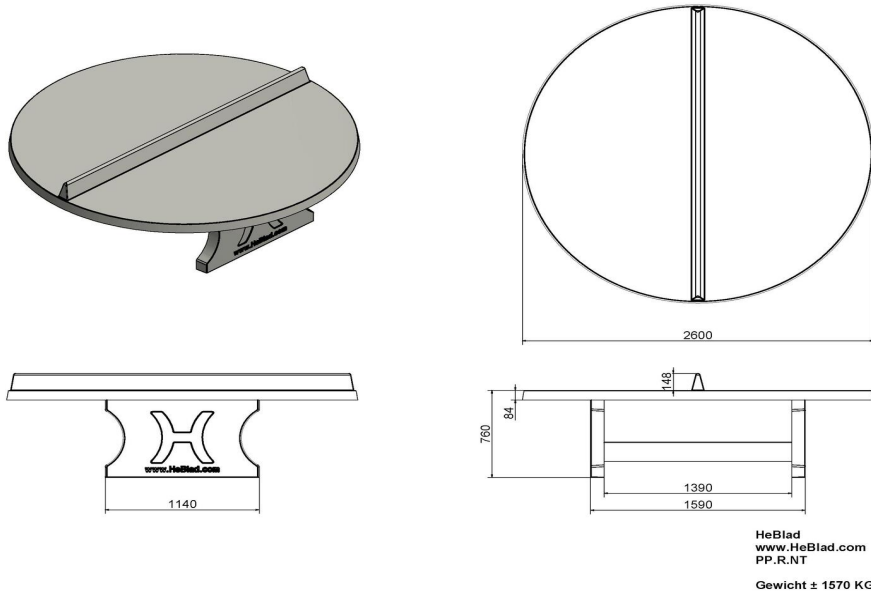

Specifications Round Ping-pong table in Natural Concrete

Product code	PP.R.NT	Height tabletop	76 cm
Colour	Natural concrete	Height of the net	14,75 cm
Dimension playing surface (L x W)	∅ 260 cm	Weight	1570 kg
Dimensions bottom of playing surface	∅ 264 cm	Distance legs	149 cm (center to center)
Tabletop thickness	8,4 cm		

Related products



PP.AR.GR



PP.BL



B.DS10



OP.PP



B.S1

Our products are delivered from our factory in the Netherlands.



Picnic table Standard Natural Concrete Wheelchair accessible

£ 2,650.00 excl. VAT
(£ 3,180.00 incl. VAT)

Product code: PS,ST,RT

A beautiful, robust picnic set cast from concrete, suitable for every user. This picnic table has been made wheelchair accessible. The wheelchair user can sit at the table, instead of next to it. By elongating one side of the table, this picnic set is now suitable for almost any wheelchair. The tabletop of the concrete standard picnic set that is wheelchair accessible is higher and longer than the regular picnic sets, but of course just as strong. This way, everyone can sit at the same eye level.

What are the variants of the picnic table?

This beautiful concrete standard picnic set that is wheelchair accessible is also available in anthracite concrete and in standard anthracite. Would you prefer a softer seat? No problem! HeBlad also makes these picnic sets with a bamboo seat in the DeLuxe version. The DeLuxe picnic sets that are wheelchair accessible can also be ordered in the standard concrete colour, the anthracite-concrete version and the standard anthracite version.

Where can the picnic sets be placed?

Because of its colour, this picnic table fits into any environment. A natural, practical addition to the schoolyard, in the park, in the city center or on the grounds of a hospital or other (care) institution. The perfect place to bring people together and because this concrete addition is wheelchair friendly, everyone is welcomed. Make this place even more attractive by combining the picnic table with a game or interactive table such as a table tennis table, a foot volleyball table or checkers, chess or ludo table. Fun guaranteed!

3 April 2025 - Prices subject to change

Our products are delivered from our factory in the Netherlands.



correspondence address

HeBlad - UK

The Balance, 7th floor, Pinfold Street
S1 2GU Sheffield, South Yorkshire
T. 0114 352 0110
info@HeBlad.co.uk
www.HeBlad.co.uk

head office address

HeBlad BV

Diamantweg 22
NL - 5527 LC Hapert

Is a base plate needed for the picnic table?

If the picnic table will be placed on a softer surface, such as grass or sand, we recommend placing the picnic table on a sturdy base plate. Because we produce both the picnic sets and the base plates ourselves, we always have the suitable base plate for your picnic set. We can make the entire structure wheelchair accessible, regardless of the surface. Please feel free to contact us to discuss all options.

Our products are delivered from our factory in the Netherlands.

Registered under: HeBlad BV • HM Revenue and Customs • Ruby House 8 • Ruby Place • AB10 1ZP Aberdeen
VAT Number GB381060225 • EORI Number GB381060225000 • Commercial register (NL) 170 66 364
Rabobank De Kempen, Markt 7, 5531 BA Bladel (NL) • BIC RABONL2U • Branch code RABONL2UXXX • IBAN NL 20 RABO 0107530112 GBP

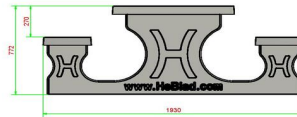
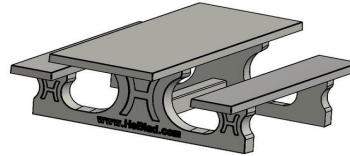
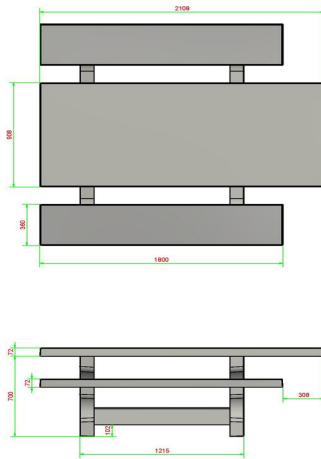

HeBlad
www.HeBlad.com
PS.ST.RT
± 970 kg

Specifications Picnic table Standard Natural Concrete Wheelchair accessible

Product code	PS.ST.RT	Seat height	50 cm
Colour	Natural concrete	Material seat	Beton
Dimensions (L x W x H)	210 x 187 x 77 cm	Distance legs	111 cm (Hart op Hart)
Dimensions tabletop (L x W)	210 x 90	Weight	970 kg
Tabletop thickness	7 cm	Number of seats	7

Related products 77 cm



PS.DLA.RT



PS.DLAB.RT



PS.DL.RT



PS.DLAB.RT

Our products are delivered from our factory in the Netherlands.



Picnic table Standard Anthracite-Concrete Wheelchair accessible

£ 2,800.00 excl. VAT
(£ 3,360.00 incl. VAT)

Product code: PS_STAB_RT

How beautiful is this anthracite concrete picnic table that also accommodates a wheelchair? At the head of the table, a wheelchair user can easily take a place. Because the tabletop has been extended and raised, the wheelchair user does not have to sit next to the table, but can simply join in.

Concrete picnic set with special dimensions for wheelchairs

By extending the tabletop on one side and adjusting the height of the tabletop, space has been created for a wheelchair user to join. The seat height of the accompanying benches has also been adjusted, so all users of the picnic table sit at the same height. The seat height is also perfect in relation to the height of the tabletop. This standard anthracite-concrete picnic set is wheelchair accessible and comfortable for every user.

HeBlad Picnic set: robust, beautiful and wheelchair-friendly

This solid, sturdy version of the wheelchair-accessible picnic set is made of coloured concrete. The anthracite concrete version shows off the concrete appearance very nicely, a natural variation on the natural concrete version of this picnic table. The concrete look is even retained in case of damage, because the set is made of coloured concrete. The colour was not created by painting the set, but by colouring the concrete itself. This picnic set can also be supplied in standard anthracite, the colour anthracite without the concrete look.

Brighten up every square and park with game tables, picnic sets and benches from HeBlad

3 April 2025 - Prices subject to change

Our products are delivered from our factory in the Netherlands.



correspondence address

HeBlad - UK

The Balance, 7th floor, Pinfold Street
S1 2GU Sheffield, South Yorkshire
T. 0114 352 0110
info@HeBlad.co.uk
www.HeBlad.co.uk

head office address

HeBlad BV

Diamantweg 22
NL - 5527 LC Hapert

HeBlad's game tables, benches and picnic sets adorn playgrounds, city centers, gardens and parks. For example, combine this beautiful picnic set standard anthracite-concrete wheelchair accessible with a trendy foot volleyball table or one of the sturdy concrete benches from HeBlad. We manage production in our own factory and also take care of delivery. So, you've come to the right place to decorate your square, garden or park.

Please feel free to contact us, we will be happy to discuss the possibilities.

*The base plate is optional

Our products are delivered from our factory in the Netherlands.

Registered under: HeBlad BV • HM Revenue and Customs • Ruby House 8 • Ruby Place • AB10 1ZP Aberdeen
VAT Number GB381060225 • EORI Number GB381060225000 • Commercial register (NL) 170 66 364
Rabobank De Kempen, Markt 7, 5531 BA Bladel (NL) • BIC RABONL2U • Branch code RABONL2UXXX • IBAN NL 20 RABO 0107530112 GBP

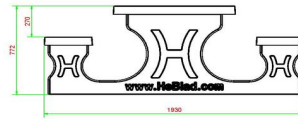
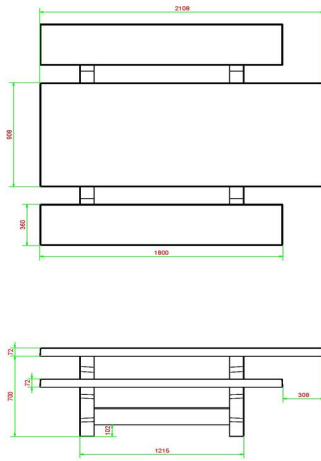

HeBlad
www.HeBlad.com
PS.STAB.RT
± 970 kg

Specifications Picnic table Standard Anthracite-Concrete Wheelchair accessible

Product code	PS.STAB.RT	Seat height	50 cm
Colour	Anthracite concrete	Material seat	Beton
Dimensions (L x W x H)	210 x 187 x 77 cm	Distance legs	111 cm (center to center)
Dimensions tabletop (L x W)	210 x 90 cm	Weight	970 kg
Tabletop thickness	7 cm	Number of seats	7

Related products 77 cm



PS.DLA.RT



PS.DLAB.RT



OP.PP.AB

Our products are delivered from our factory in the Netherlands.



Concrete Picnic table Standard Anthracite Wheelchair accessible

£ 2,750.00 excl. VAT
(£ 3,300.00 incl. VAT)

Product code: PS.STA.RT

This elegant picnic set is anthracite lacquered in the colour RAL 7016. It has a free space of 60 cm deep and 70 cm high and is specifically designed for the accessibility of wheelchair users. You never have to sit next to a picnic table again, you can finally sit at the table together with non-wheelchair users. That makes this picnic set wheelchair accessible and the place to bring everyone together.

Robust picnic set resistant to weather influences

At HeBlad we produce everything ourselves. We stand for reliability and ease of use. All our concrete benches, game tables and the picnic sets are intended for outdoor use. Our products are resistant to all types of weather and radiate such robustness that they do not invite vandalism. The tables are robust and sturdy, without loss of elegance. Because HeBlad products are often the gathering point for social instances, we are proud of the production of this standard anthracite picnic set that is wheelchair accessible. No one is left out, everyone at the table together!

Maintenance-free, concrete picnic set

Are you planning to place this picnic set in a place where it is not cleaned daily and where there is little or no supervision? No problem. Our tables guarantee safety.

The anthracite lacquer which this picnic set has been treated with makes maintaining the table easy. Simply clean with water, possibly with soapy water, and the table is like new again. Do you opt for an additional concrete base plate?

3 April 2025 - Prices subject to change

Our products are delivered from our factory in the Netherlands.



correspondence address

HeBlad - UK

The Balance, 7th floor, Pinfold Street
S1 2GU Sheffield, South Yorkshire
T. 0114 352 0110
info@HeBlad.co.uk
www.HeBlad.co.uk

head office address

HeBlad BV

Diamantweg 22
NL - 5527 LC Hapert

Then you can easily sweep under the table. This makes it easy to keep the area clean.

Delivery of the wheelchair-friendly picnic table

Almost all HeBlad products are available from stock, with a delivery time between 0 and 4 working weeks in the Netherlands. This is usually around 6 working weeks in the UK. For more detailed information, please regard our delivery terms and conditions or contact us.

Because our products are made of concrete and often manufactured in one piece, they are delivered via the loading/unloading crane from our truck. The crane has a maximum reach of 5 meters, when the route to the right place is accessible, the product can be moved further with a pallet truck. Check the delivery conditions to see if your space meets the requirements. If in doubt, always contact us to discuss the options so that we can ensure installation at your location runs smoothly.

*The base plate is optional

Our products are delivered from our factory in the Netherlands.

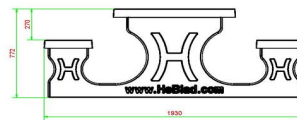
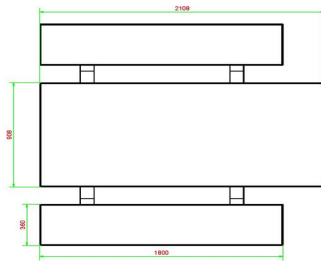

HeBlad
www.HeBlad.com
PS.STA.RT
± 970 kg

Specifications Concrete Picnic table Standard Anthracite Wheelchair accessible

Product code	PS.STA.RT	Seat height	50 cm
Colour	Anthracite lacquered, RAL 7016	Material seat	Beton
Dimensions (L x W x H)	210 x 187 x 77 cm	Distance legs	111 cm (center to center)
Dimensions tabletop (L x W)	210 x 90 cm	Weight	970 kg
Tabletop thickness	7 cm	Number of seats	7

Related products



PS.DLA.RT



PS.STAB.RT



OP.PS



OP.PS.AB

Our products are delivered from our factory in the Netherlands.



Bottom plate Picnic set 246cm

Product code: OP.PS.AB.246

£ 2,100.00 excl. VAT
(£ 2,520.00 incl. VAT)

3 April 2025 - Prices subject to change

Our products are delivered from our factory in the Netherlands.

Specifications Bottom plate Picnic set 246cm

Product code	OP.PS.AB.246	Weight	1700 kg
Colour	Anthracite concrete	lifting device	Concrete lifting device
Dimensions (L x W x H)	245 x 300 x 10 cm	preparation attachment	Holes for bolts M16
Finishing base plate	Smooth concrete		

head office address

HeBlad BV
Diamantweg 22
5527 EC Hapert
Concrete Street 11

Related products



OP.PS.246



PS.DL.246



PS.ST.246



PS.DLAB.246



PS.STA.246

Our products are delivered from our factory in the Netherlands.



Bottom plate Picnic set 246cm

Product code: OP.PS.AB.246

£ 2,100.00 excl. VAT
(£ 2,520.00 incl. VAT)

3 April 2025 - Prices subject to change

Our products are delivered from our factory in the Netherlands.

Specifications Bottom plate Picnic set 246cm

Product code	OP.PS.AB.246	Weight	1700 kg
Colour	Anthracite concrete	lifting device	Concrete lifting device
Dimensions (L x W x H)	245 x 300 x 10 cm	preparation attachment	Holes for bolts M16
Finishing base plate	Smooth concrete		

head office address

HeBlad BV
Diamantweg 22
5527 EC Hapert
Concrete Street 11

Related products



OP.PS.246



PS.DL.246



PS.ST.246



PS.DLAB.246



PS.STA.246

Our products are delivered from our factory in the Netherlands.



Repair Kit table tennis green

Product code: HB.Repair.PP.GR

£ 200.00 excl. VAT
(£ 240.00 incl. VAT)

Although we at HeBlad stand for quality and sustainability, things can sometimes go wrong. That is why we offer a repair kit, so that you can patch up your table tennis table yourself when necessary. This repair kit is suitable for versions in green, but we also offer a respective solution for the versions in blue and anthracite.

Would you like to return your table tennis table?

Did you know that you can also return the table tennis table? This is possible when you purchase a new table tennis table from HeBlad. When the new table tennis table is delivered, we will immediately relieve you of the old one. Want to know more or have questions about the costs? Please contact us, we will be happy to help you.

Repair your table yourself

You will receive instructions with the repair kit. It is advisable to read this and, if necessary, watch the instructional video before you start. Before you start, take care of your own safety: wear the safety goggles and gloves that come with the kit.

3 April 2025 - Prices subject to change

Our products are delivered from our factory in the Netherlands.

Specifications Repair Kit table tennis green

Product code HB.Repair.PP.GR

head office address

HeBlad BV
Diamantweg 22
NL - 5527 LC Hapert

Related products



HB.Repair.AB



HB.Repair.PP.A



PP.AR.GR



PP.GR



PP.AR.LOW.GR

Our products are delivered from our factory in the Netherlands.



Repair kit ping pong table Blue

Product code: HB.Repair.PP.BL

£ 200.00 excl. VAT
(£ 240.00 incl. VAT)

HeBlad offers a handy Repair Kit with which you can carry out the necessary repairs yourself. This kit is suitable for table tennis tables in blue, but suitable solutions are also available for the green and other anthracite-coloured variants.

Return your table tennis table

HeBlad also offers the option to return your table tennis table when purchasing a new table tennis table. When the new table tennis table is delivered, they will take your old table tennis table with them. If you would like to learn more about this option or have any questions about costs, please feel free to contact us for more information.

Instructions for the repair

If you would like to carry out the repair yourself, you will receive an instruction leaflet with the repair kit. It is wise to read this first and, if necessary, also watch the accompanying instructional video before starting the repair.

If you have any further questions or need assistance, our team is here to assist you. Please contact us for this.

3 April 2025 - Prices subject to change

Our products are delivered from our factory in the Netherlands.

Specifications Repair kit ping pong table Blue

Product code HB.Repair.PP.BL

head office address

HeBlad BV
Diamantweg 22
NL - 5527 LC Hapert

Related products



HB.Repair.AB



HB.Repair.PP.A



PP.AR.BL



PP.BL



PP.AR.LOW.BL

Our products are delivered from our factory in the Netherlands.



Repair Kit ping pong table Anthracite

Product code: HB.Repair.PP.A

£ 200.00 excl. VAT
(£ 240.00 incl. VAT)

That is possible with the Repair Kit. This Repair Kit is suitable for the table tennis table in the colour anthracite. Of course there are also Repair Kits for the blue and green versions. Please check carefully that you are ordering the correct colour.

Follow the instructions

If you are going to refurbish the table tennis table with the Repair Kit, it is advisable to first go through the steps carefully and watch the instructional video. It is advisable to refurbish the table tennis table in a dry and dust-free environment. We have also made an instructional video for moving the table tennis table. It is important that you clean the table thoroughly in advance and let it dry before you start working with the Repair Kit. You can see the next steps in the video and read in the package leaflet.

Return table tennis table

Are you opting for a new table tennis table instead of renovating the table? Then, when delivering the new table tennis table, we can also ensure that the old table tennis table is returned. Then you do not have to move the heavy table yourself. Please contact us for this.

3 April 2025 - Prices subject to change

Our products are delivered from our factory in the Netherlands.

Specifications Repair Kit ping pong table Anthracite

Product code HB.Repair.PP.A

head office address

HeBlad BV
Diamantweg 22
NL - 5527 LC Hapert

Related products



HB.Repair.AB



HB.Repair.PP.BL



PP.AR.A



PP.A



PP.AR.LOW.A

Our products are delivered from our factory in the Netherlands.



Repair kit Anthracite-Concrete

Product code: HB.Repair.AB

£ 25.00 excl. VAT
(£ 30.00 incl. VAT)

3 April 2025 - Prices subject to change

Our products are delivered from our factory in the Netherlands.

Specifications Repair kit Anthracite-Concrete

Product code HB.Repair.AB

head office address

HeBlad BV
Diamantweg 22
NL - 5527 LC Hapert

Related products

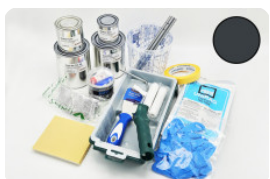

HB.Repair.PP.A



HB.Repair.PP.BL



PP.AR.AB



PP.AB



PP.R.AB

Our products are delivered from our factory in the Netherlands.

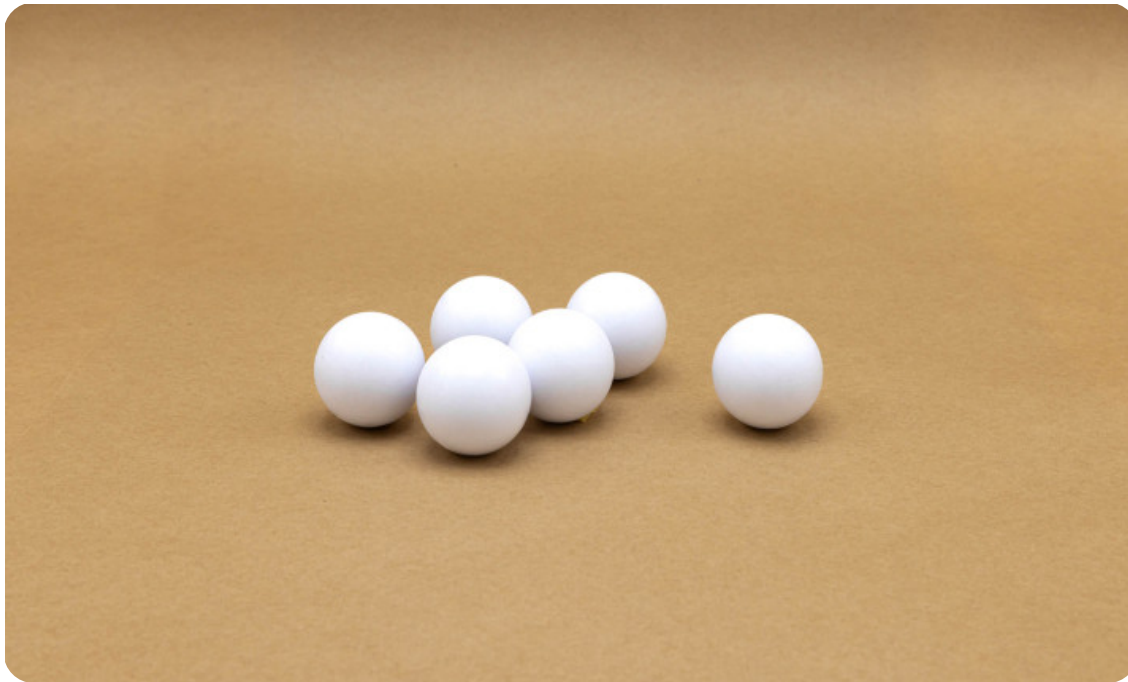

Set of 6 table football balls standard white

Product code: HB.FB.6White

£ 8.00 excl. VAT
(£ 9.60 incl. VAT)

The beautiful football table from HeBlad comes standard with a set of 6 table football balls. And we know that balls often disappear miraculously. That's why you can easily order a set of six hard football balls. We will immediately ship your balls the day after placing your order.

How many table football balls are needed?

Depending on the number of football tables and users, the number of balls you keep in stock is large or minimal. The more tables and players, the greater the chance that balls will be lost. That is why we have a set of 25 table football balls for large use.

How much are table football balls?

The larger the purchase quantity, the cheaper the balls are. A set of six balls is included free of charge with the table. If you order an extra stock of balls directly from the table, you will also enjoy an extra discount. This way you never pay too much for the table football balls.

Table football balls and other accessories

The HeBlad table football table consists of many different parts. We have many accessories for this that can be ordered separately, so that you always have a well-functioning table with the right attributes. Consider, for example, eye protectors or rubber bumpers.

You can also order handles, rods and figures according to your wishes. If a part of the table unexpectedly breaks, you will have a replacement product in the foreseeable future and you can play table football again.

Contact HeBlad

3 April 2025 - Prices subject to change

Our products are delivered from our factory in the Netherlands.



correspondence address

HeBlad - UK

The Balance, 7th floor, Pinfold Street
S1 2GU Sheffield, South Yorkshire
T. 0114 352 0110
info@HeBlad.co.uk
www.HeBlad.co.uk

head office address

HeBlad BV

Diamantweg 22
NL - 5527 LC Hapert

Do you have any questions about the accessories of the foosball table? Please feel free to contact us.

Our products are delivered from our factory in the Netherlands.

Registered under: HeBlad BV • HM Revenue and Customs • Ruby House 8 • Ruby Place • AB10 1ZP Aberdeen
VAT Number GB381060225 • EORI Number GB381060225000 • Commercial register (NL) 170 66 364
Rabobank De Kempen, Markt 7, 5531 BA Bladel (NL) • BIC RABONL2U • Branch code RABONL2UXXX • IBAN NL 20 RABO 0107530112 GBP

Specifications Set of 6 table football balls standard white

Product code	HB.FB.6White
Material	Kunststof

head office address

HeBlad BV
Diamantweg 22
NL - 5527 LC Hapert

Related products



HB.FB.25White



HB.FB.A



HB.FBSC.Orange

Our products are delivered from our factory in the Netherlands.



Bag with 25 table football balls standard white

Product code: HB.FB.25White

£ 28.00 excl. VAT
(£ 33.60 incl. VAT)

Do you ever have enough balls for your table football game? Especially if the game is played intensively and regularly, balls can become lost or damaged. Then it is very nice if you can pick up a new ball without thinking and continue playing immediately. With every HeBlad table football table you will receive 6 table football balls for free. This will probably last you for some time, but an extra stock is never a problem. If you order this set of 25 balls directly from your table football table, you will also receive a nice discount on this set of 25 balls. Worth stocking up on.

What are table football balls made of?

The material we use is hard plastic. This ensures that the ball can be used outdoors and that it rolls well on the game table. The balls can also be easily cleaned with dishwashing liquid and warm water.

Delivery of the table football balls

If you order the accessories separately, we will ship your order the day after you place the order. If you ordered the balls together with a table football table, you will receive the balls together with the table.

We usually also deliver complete gaming tables quickly. Because we produce our products ourselves in Hapert, The Netherlands and deliver and install the products ourselves, you don't have to wait long for your products.

Please check the delivery conditions carefully in advance or contact us. This way no one will be faced with unwanted surprises.

3 April 2025 - Prices subject to change

Our products are delivered from our factory in the Netherlands.

Specifications Bag with 25 table football balls standard white

Product code	HB.FB.25White
Material	Kunststof

head office address

HeBlad BV
Diamantweg 22
NL - 5527 LC Hapert

Related products



HB.FB.6White



HB.FB.Handle



HB.FB.Eye.set8



HB.FB.A



HB.FBSC.Green

Our products are delivered from our factory in the Netherlands.



Single football figure available

Product code: HB.FB.DOLL

£ 6.00 excl. VAT
(£ 7.20 incl. VAT)

A game of table football can only be played properly if all players are on the field. Sometimes it happens that one of the football dolls sustains damage or even falls off the bar. You really don't have to replace the entire football table. Order your football doll separately on our website and replace your damaged doll yourself. This way you have a complete table that is ready for the football game.

What is a football doll made of?

Because HeBlad products are intended for outdoor use, the football dolls are also made of unbreakable plastic. They can withstand freezing cold, but also extreme heat. What colours are the football dolls available in? You can choose from 8 different colours for the football dolls: black, white, orange, blue, yellow, red, purple and green. This way you put together your teams yourself, by colour.

Replace multiple football dolls at the same time

Would you like to replace an entire football team in your football table? That's also possible. Then choose the doll set including 2 bumper blocks. Just like the individual dolls, you can choose from different colours here. The sets are designed for rods with a diameter of 16 mm. To make your set even more complete, you also have the option to order a doll set with scoreboard. To replace the dolls, use the supplied Allen key or order the Allen key separately.

When you order accessories from HeBlad, we will ship them immediately the next working day. So you can have your table in order in no time.

Advice and help with replacing football dolls

If you are not convinced of your knowledge to replace the dolls or you need advice, please contact us. We are happy to help you.

3 April 2025 - Prices subject to change

Our products are delivered from our factory in the Netherlands.



correspondence address

HeBlad - UK

The Balance, 7th floor, Pinfold Street
S1 2GU Sheffield, South Yorkshire
T. 0114 352 0110
info@HeBlad.co.uk
www.HeBlad.co.uk

head office address

HeBlad BV

Diamantweg 22
NL - 5527 LC Hapert

[Click here and have a look at the strength of our figures shown in a test.](#)

Our products are delivered from our factory in the Netherlands.

Registered under: HeBlad BV • HM Revenue and Customs • Ruby House 8 • Ruby Place • AB10 1ZP Aberdeen
VAT Number GB381060225 • EORI Number GB381060225000 • Commercial register (NL) 170 66 364
Rabobank De Kempen, Markt 7, 5531 BA Bladel (NL) • BIC RABONL2U • Branch code RABONL2UXXX • IBAN NL 20 RABO 0107530112 GBP

Specifications Single football figure available

Product code	HB.FB.DOLL
Material	Kunststof

head office address

HeBlad BV
Diamantweg 22
NL - 5527 LC Hapert

Related products



HB.FB.A



PP.AR.GR

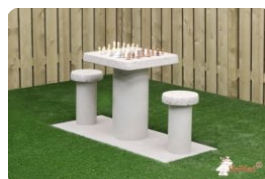

GT.CH.G2

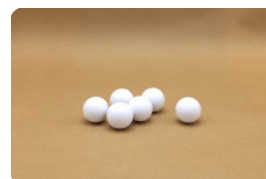

HB.FB.Ball6



HB.FBP.Set

Our products are delivered from our factory in the Netherlands.



Set of football players

Product code: HB.FBP.Set

£ 55.00 excl. VAT
(£ 66.00 incl. VAT)

Does your football team need replacing? No problem! Choose a colour and order 11 new players, including two cushions that are placed on either side of the goalkeeper. By placing new football dolls, your foosball table will be like new again.

Doll set and other accessories

Does your football table squeak and creak a bit, or do you want to give the table a makeover? Then try replacing individual accessories of the table before ordering a completely new football table. Think sustainably and financially attractively, that benefits everyone.

What is needed for a table football game?

In addition to a complete and well-functioning table, players and fun, table footballs are essential. HeBlad supplies six loose balls with each table football table. But we know from experience that these balls often get lost. That is why we offer you these separate balls. You can't have enough in stock. If you order extra balls directly when purchasing your table, you will also receive a nice discount on the balls. This way you are assured of fun playing on your football table for a long time.

Fast delivery football table and doll set

What is the delivery time of the doll set? Because we design and produce everything in-house in Hapert, we can deliver all products and accessories

3 April 2025 - Prices subject to change

Our products are delivered from our factory in the Netherlands.



correspondence address

HeBlad - UK

The Balance, 7th floor, Pinfold Street
S1 2GU Sheffield, South Yorkshire
T. 0114 352 0110
info@HeBlad.co.uk
www.HeBlad.co.uk

head office address

HeBlad BV

Diamantweg 22
NL - 5527 LC Hapert

quickly. For the delivery and installation of the football table, we always refer to our terms of delivery or we ask you to contact us in advance. This way we can be sure that we can place the table correctly and safely on your site.
Click here and have a look at the strength of our figures shown in a test.

Our products are delivered from our factory in the Netherlands.

Registered under: HeBlad BV • HM Revenue and Customs • Ruby House 8 • Ruby Place • AB10 1ZP Aberdeen
VAT Number GB381060225 • EORI Number GB381060225000 • Commercial register (NL) 170 66 364
Rabobank De Kempen, Markt 7, 5531 BA Bladel (NL) • BIC RABONL2U • Branch code RABONL2UXXX • IBAN NL 20 RABO 0107530112 GBP

Specifications Set of football players

Product code	HB.FBP.Set
Material	Kunststof

head office address

HeBlad BV
Diamantweg 22
NL - 5527 LC Hapert

Related products



HB.FB.A



PP.AR.BL

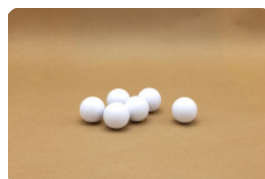

HB.FB.Ball6

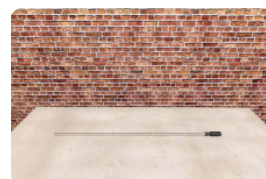

HB.FB.Rod



HB.FB.DOLL.Purp

Our products are delivered from our factory in the Netherlands.



Set of kickers with scoreboard

Product code: HB.FBSC.set

£ 79.00 excl. VAT
(£ 94.80 incl. VAT)

How are puppets replaced in a foosball game? The dolls are mounted on a football bar. It is therefore important to carefully disassemble the football bar, including the rubbers and handles. Then you remove the dolls from the rod and you can mount the new dolls. If you want to replace all the dolls in the game, keep a close eye on which rod needs to be replaced where in the game, because all rods have their own hole pattern and length.

Football doll set in different colours

We offer the complete football doll set in eight different colours. So you can put together your own team in colour, completely in the style of your favorite football club or favorite colour. We also offer a scoreboard in the same colour.

What tools are used when replacing a football puppet set? When replacing the football figures, you use a 2.5 mm or 4 mm Allen key. These are included when ordering the football doll set with scoreboard, but you can also order both separately via the website. Which materials can be replaced in a football table?

If during disassembly it turns out that the bars, rubber bumpers, handles or eye protectors also need to be replaced, you can also order these. This way you keep your table tidy and in working order.

Football doll set and other accessories

HeBlad is proud of the quality it delivers. Solid products and strong accessories, all intended for years of fun outdoors. We do not skimp on materials, so we can always supply you with the very best product. Would you like to know more about HeBlad's solid products? Please contact us. We are happy to advise which gaming tables suit you.

3 April 2025 - Prices subject to change

Our products are delivered from our factory in the Netherlands.

Specifications Set of kickers with scoreboard

Product code	HB.FBSC.set
Material	Kunststof

head office address

HeBlad BV
Diamantweg 22
NL - 5527 LC Hapert

Related products



HB.FB.A



PP.AR.GR

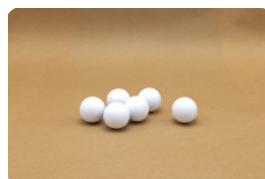

HB.FB.Ball6



HB.FB.DOLL



HB.FB.DOLL.Purp

Our products are delivered from our factory in the Netherlands.



Eye protector for rods

Product code: HB.FB.ey

£ 5.00 excl. VAT
(£ 6.00 incl. VAT)

The so-called eye protectors for the football table are placed on the ends of the rods that protrude from the football table. Why eye protectors? This protection is intended to protect small children from bumping into the bars. These bars are exactly at eye level for them.

A single eye protector

This eye protector is available as a single piece or in a set of 8. Because the football table has 8 bars, a complete set ensures a completely safe table. The end caps are placed on a football table as standard, but you can also order the eye protectors separately.

Which table do the eye protectors fit on?

These eye protectors fit the HeBlad football table, as they have been specifically developed for that. If you have another football table, these caps could also fit. If the rods have a diameter of 16 mm, the caps could be made to fit with a small adjustment. Always contact us first.

Each game table has its own accessories

In addition to eye protectors, HeBlad also has other attributes for the football table that you can order separately. This also applies to the other game tables, each game has its own accessories. You can find which accessories belong to which table on the website or ask one of our employees.

3 April 2025 - Prices subject to change

Our products are delivered from our factory in the Netherlands.

Specifications Eye protector for rods

Product code	HB.FB.eye
Material	Rubber

head office address

HeBlad BV
Diamantweg 22
NL - 5527 LC Hapert

Related products



HB.FB.6White



HB.FBSC.Yellow

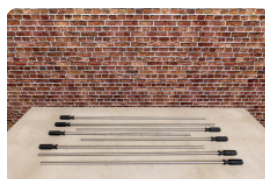

HB.FB.Rodset



HB.FBP.Blue



HB.FB.DOLL.Purp

Our products are delivered from our factory in the Netherlands.



Eye protectors set of 8 pieces.

Product code: HB.FB.Eye.set8

£ 35.00 excl. VAT
(£ 42.00 incl. VAT)

What are eye protectors? These end caps are placed over the parts of the bars that protrude from the football table. Because these bars protrude from the table at eye level for small children, it is important to prevent injury if someone bumps into the bar.

How many eye protectors are needed?

Because the football table has eight rods, one end of which does not have a handle, eight end caps are required. That's why we offer you a set of 8 eye protectors. If you are only missing one end cap, you can also order it in single pieces.

These eye protectors can also be attached to other tables. If the rod has a diameter of 16 mm, a small adjustment will probably be necessary. Please contact us for this. We are happy to help you with the safety around your football table.

Eye protectors and handles

One side of the bar in the football table is now equipped with an eye protector. The other side has a rubber handle. Because both sides have rubber ends, the table is safe to place on playgrounds where many children play.

Where can the football tables be placed?

Because the foosball game is played by four or more people of any age, the table can be placed in many places. Schoolyards, parks, parking lots or in company yards. Would you like to know whether a HeBlad football table is suitable for your site? Please contact us, we will be happy to advise you.

3 April 2025 - Prices subject to change

Our products are delivered from our factory in the Netherlands.



correspondence address

HeBlad - UK

The Balance, 7th floor, Pinfold Street
S1 2GU Sheffield, South Yorkshire
T. 0114 352 0110
info@HeBlad.co.uk
www.HeBlad.co.uk

head office address

HeBlad BV

Diamantweg 22
NL - 5527 LC Hapert

Delivery of the table football balls

If you order the accessories separately, we will ship your order the day after you place the order. If you ordered the balls from a table football table, you will receive the balls together with the table.

We usually also deliver complete gaming tables quickly. Because we produce ourselves in Hapert, The Netherlands, and deliver and install the products ourselves, you never have to wait long on your order.

Please check the delivery conditions carefully in advance or contact us. This way no one will be faced with unwanted surprises.

Our products are delivered from our factory in the Netherlands.

Registered under: HeBlad BV • HM Revenue and Customs • Ruby House 8 • Ruby Place • AB10 1ZP Aberdeen
VAT Number GB381060225 • EORI Number GB381060225000 • Commercial register (NL) 170 66 364

Rabobank De Kempen, Markt 7, 5531 BA Bladel (NL) • BIC RABONL2U • Branch code RABONL2UXXX • IBAN NL 20 RABO 0107530112 GBP

Specifications Eyeprotectors set of 8 pieces.

Product code	HB.FB.Eye.set8
Material	Rubber

head office address

HeBlad BV
Diamantweg 22
NL - 5527 LC Hapert

Related products



HB.FB.6White

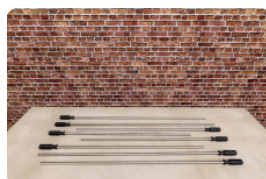

HB.FB.Rodset



HB.FBSC.Yellow

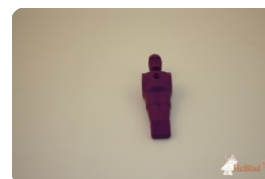

HB.FB.DOLL.Purp



HB.FBP.Blue

Our products are delivered from our factory in the Netherlands.



Rubber damper

Product code: HB.FB.bumper

£ 2.75 excl. VAT
(£ 3.30 incl. VAT)

Why rubber bumpers? The HeBlad football table is specifically designed for outdoor use, which is why we opted for rubber bumpers instead of the regular metal suspension. Rubber is not sensitive to bad weather conditions. A nice side effect is that the rubber bumpers make less noise.

How are the rubber bumpers replaced?

To replace the rubber bumper, the dolls are rotated from the rod. This can be done with an Allen key size 2.5 mm. The rubbers have a diameter of 15 mm, so that they fit tightly around the rods with a diameter of 16 mm. To replace all rubber bumpers in the football table, you can also order a set of 16 bumpers directly.

Rubber bumper and other accessories

The table football game is played with a hard plastic ball. The other accessories are attached to the table, but these can also be ordered separately.

Questions about replacing rubber bumpers

Do you have questions about replacing the rubber bumpers or other accessories of the football table? Please contact us. No one understands our football table better than we do. We can probably help you remotely to replace the right parts properly.

3 April 2025 - Prices subject to change

Our products are delivered from our factory in the Netherlands.

Specifications Rubber damper

Product code	HB.FB.bumper
Material	Rubber

head office address

HeBlad BV
Diamantweg 22
NL - 5527 LC Hapert

Related products



HB.FB.A



PP.AR.GR

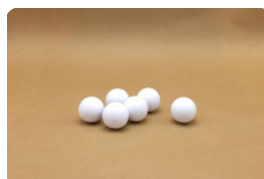

HB.FB.Ball6



HB.FB.DOLL

Our products are delivered from our factory in the Netherlands.



Set of rubber dampers for football table, 16 pcs.

Product code: HB.FB.Bumperset

£ 35.00 excl. VAT
(£ 42.00 incl. VAT)

The HeBlad football table is made up of many different parts and specifically designed for outdoor use. To ensure that you can use your football table at all times, we offer accessories for the table separately.

When to replace rubber bumpers?

You replace these rubber bumpers as soon as they are worn or broken. This ensures that you can continue to play the game properly. The bumpers guide the rods and provide noise reduction while playing. By ordering a set of 16 rubber bumpers, you can immediately provide the entire table with new ones.

A single rubber bumper

Do you think a set of 16 rubber bumpers is too much? Then you can also order the rubber bumpers as single pieces.

How are the bumpers replaced?

When a bumper needs to be replaced, unscrew the plugs from the rods. Use a 2.5 mm Allen key for this.

You can also order the dolls and rods separately from the table. This way you always keep your table complete.

What are the rules of table football?

To play the table football game well, a number of rules are important. For example, the rod may not be rotated completely and the game is played with one ball. Of course it is essential that the table is complete and level.

Contact HeBlad

3 April 2025 - Prices subject to change

Our products are delivered from our factory in the Netherlands.



correspondence address

HeBlad - UK

The Balance, 7th floor, Pinfold Street
S1 2GU Sheffield, South Yorkshire
T. 0114 352 0110
info@HeBlad.co.uk
www.HeBlad.co.uk

head office address

HeBlad BV

Diamantweg 22
NL - 5527 LC Hapert

For all your questions about the game, the table or the accessories, we cordially invite you to contact us.

Our products are delivered from our factory in the Netherlands.

Registered under: HeBlad BV • HM Revenue and Customs • Ruby House 8 • Ruby Place • AB10 1ZP Aberdeen
VAT Number GB381060225 • EORI Number GB381060225000 • Commercial register (NL) 170 66 364
Rabobank De Kempen, Markt 7, 5531 BA Bladel (NL) • BIC RABONL2U • Branch code RABONL2UXXX • IBAN NL 20 RABO 0107530112 GBP

Specifications Set of rubber dampers for football table, 16 pcs.

Product code HB.FB.Bumperset
Material Rubber

head office address

HeBlad BV
Diamantweg 22
NL - 5527 LC Hapert

Related products



HB.FB.A



PP.AR.BL



GT.CK.G4

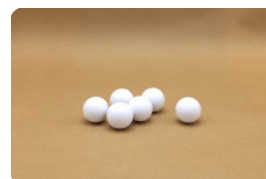

HB.FB.Ball6



HB.FB.DOLL

Our products are delivered from our factory in the Netherlands.



Handle

Product code: HB.FB.Handle

£ 3.00 excl. VAT
(£ 3.60 incl. VAT)

Get a good grip on the table football game with the handles for the football table from HeBlad. These rubber handles are intended to replace damaged or lost handles on the football table. They fit perfectly on the table bars, which have a diameter of 16 mm.

These bars should also be suitable for other football tables, provided the bars have a diameter of 16 mm. If you have any doubts about the suitability of the handles, please contact us.

Order handles

How do you order the handles? You can easily order all accessories for the football table online via the webshop. All parts of the table are available separately, so you can replace them yourself if necessary.

Fun with the football table

HeBlad is known for providing gaming fun and trustworthy products. To hold true to this image, we offer the parts separately for all games that we make. This way you do not have to immediately replace the entire gaming table, but with a small repair you can provide years of outdoor fun again.

Do you have a question about replacing parts or HeBlad products? Contact us or view our offer online.

3 April 2025 - Prices subject to change

Our products are delivered from our factory in the Netherlands.

Specifications Handle

Product code	HB.FB.Handle
Material	Rubber

head office address

HeBlad BV
Diamantweg 22
NL - 5527 LC Hapert

Related products



HB.FB.A



PP.AR.BL

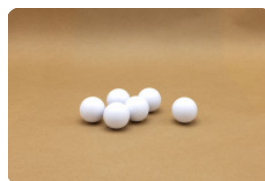

HB.FB.Ball6



HB.FB.DOLL

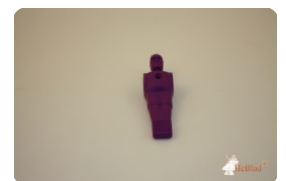

HB.FB.DOLL.Purp

Our products are delivered from our factory in the Netherlands.



Handle, set of 8

Product code: HB.FB.Handleset

£ 20.00 excl. VAT
(£ 24.00 incl. VAT)

3 April 2025 - Prices subject to change

Our products are delivered from our factory in the Netherlands.

Specifications Handle, set of 8

Product code	HB.FB.Handleset
Material	Rubber

head office address

HeBlad BV
Diamantweg 22
NL - 5527 LC Hapert

Related products



HB.FB.A

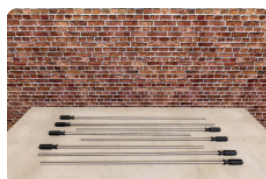

HB.FB.Rodset



HB.FB.DOLL.Purp



HB.FBSC.Purple



HB.FB.6White

Our products are delivered from our factory in the Netherlands.



Table football rod

Product code: HB.FB.Rod

£ 50.00 excl. VAT
(£ 60.00 incl. VAT)

Solid bar of stainless steel 316L for table football. The rod has prepared holes. The rods are not equal in length and number of holes, therefore it is essential to make the right choice.

You also can order a complete set of 8.

3 April 2025 - Prices subject to change

Our products are delivered from our factory in the Netherlands.

Specifications Table football rod

Product code	HB.FB.Rod
Material	Roestvrij staal, rubber

head office address

HeBlad BV
Diamantweg 22
NL - 5527 LC Hapert

Related products



HB.FB.A



PP.R.BL



GT.CK.G4

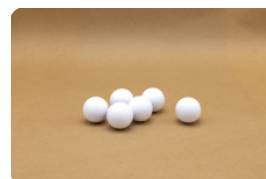

HB.FB.Ball6



HB.FBSC.set

Our products are delivered from our factory in the Netherlands.



Stainless steel rods for football game, set of 8.

Product code: HB.FB.Rodset

£ 375.00 excl. VAT
(£ 450.00 incl. VAT)

Foosball is played on a gaming table equipped with solid stainless steel bars. Each rod has its own layout with holes. The figures are secured here, on each rod in a different place. When replacing the bars, it is essential that the correct bars are placed back in the right place, otherwise the game cannot be played properly. With this set of 8 rods you always have the right rod at hand. If you only want to replace a single rod, you can also choose to order just that one rod. Then make sure you choose the right rod. If in doubt, we advise you to contact us.

How is a football pole replaced?

To replace the football bar, disassemble all figures, handles, rubbers and eye protectors. You do this using an Allen key size 2.5 mm and 4 mm. Of course, assembling the rod is done in reverse order using the same materials. Feel free to ask us to help you replace the rods if you can't figure it out yourself.

Bar set for table football

We supply each football table with all accessories, so you can easily order all parts separately. This means you do not have to immediately replace the entire table. Very sustainable and much less expensive. If you have any questions about the football table or other game tables from HeBlad, you are welcome to contact us. We are happy to tell and advise you about our gaming tables.

3 April 2025 - Prices subject to change

Our products are delivered from our factory in the Netherlands.

Specifications Stainless steel rods for football game, set of 8.

Product code	HB.FB.Rodset
Material	Roestvrij staal, rubber

head office address

HeBlad BV
Diamantweg 22
NL - 5527 LC Hapert

Related products



HB.FB.A



PP.R.GR



GT.CK.G2

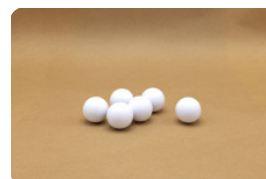

HB.FB.Ball6



HB.FBSC.set

Our products are delivered from our factory in the Netherlands.

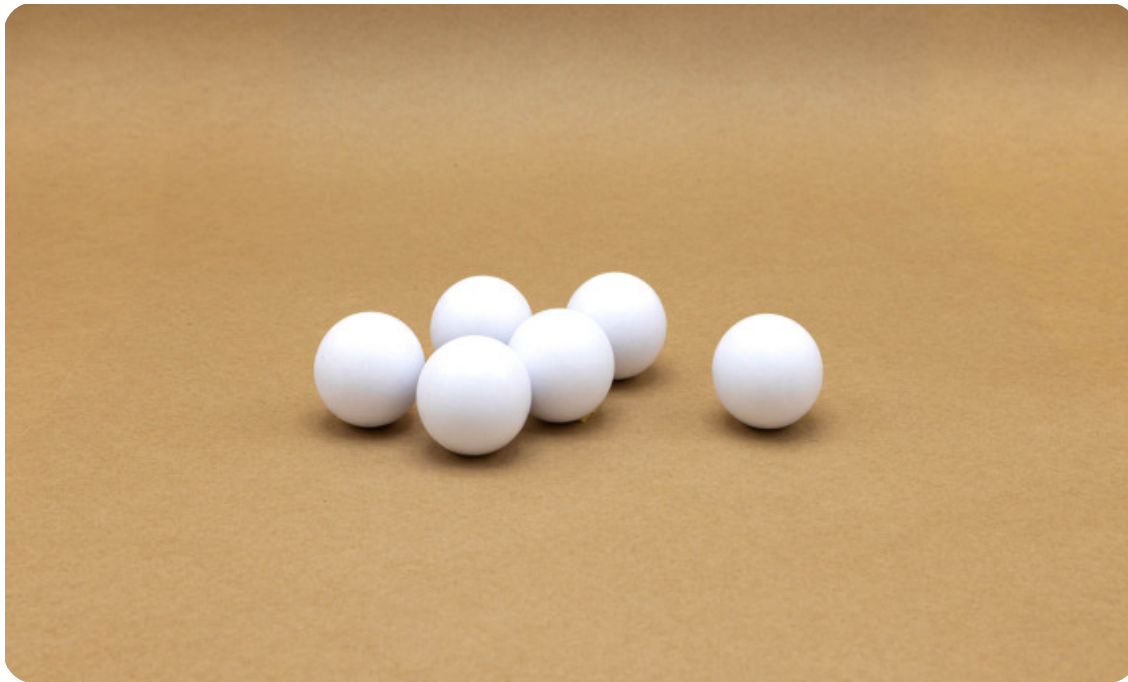

Set of 6 table football balls standard white

Product code: HB.FB.6White

£ 8.00 excl. VAT
(£ 9.60 incl. VAT)

The beautiful football table from HeBlad comes standard with a set of 6 table football balls. And we know that balls often disappear miraculously. That's why you can easily order a set of six hard football balls. We will immediately ship your balls the day after placing your order.

How many table football balls are needed?

Depending on the number of football tables and users, the number of balls you keep in stock is large or minimal. The more tables and players, the greater the chance that balls will be lost. That is why we have a set of 25 table football balls for large use.

How much are table football balls?

The larger the purchase quantity, the cheaper the balls are. A set of six balls is included free of charge with the table. If you order an extra stock of balls directly from the table, you will also enjoy an extra discount. This way you never pay too much for the table football balls.

Table football balls and other accessories

The HeBlad table football table consists of many different parts. We have many accessories for this that can be ordered separately, so that you always have a well-functioning table with the right attributes. Consider, for example, eye protectors or rubber bumpers.

You can also order handles, rods and figures according to your wishes. If a part of the table unexpectedly breaks, you will have a replacement product in the foreseeable future and you can play table football again.

Contact HeBlad

3 April 2025 - Prices subject to change

Our products are delivered from our factory in the Netherlands.



correspondence address

HeBlad - UK

The Balance, 7th floor, Pinfold Street
S1 2GU Sheffield, South Yorkshire
T. 0114 352 0110
info@HeBlad.co.uk
www.HeBlad.co.uk

head office address

HeBlad BV

Diamantweg 22
NL - 5527 LC Hapert

Do you have any questions about the accessories of the foosball table? Please feel free to contact us.

Our products are delivered from our factory in the Netherlands.

Registered under: HeBlad BV • HM Revenue and Customs • Ruby House 8 • Ruby Place • AB10 1ZP Aberdeen
VAT Number GB381060225 • EORI Number GB381060225000 • Commercial register (NL) 170 66 364
Rabobank De Kempen, Markt 7, 5531 BA Bladel (NL) • BIC RABONL2U • Branch code RABONL2UXXX • IBAN NL 20 RABO 0107530112 GBP

Specifications Set of 6 table football balls standard white

Product code	HB.FB.6White
Material	Kunststof

head office address

HeBlad BV
Diamantweg 22
NL - 5527 LC Hapert

Related products



HB.FB.25White



HB.FB.A



HB.FBSC.Orange

Our products are delivered from our factory in the Netherlands.



Bag with 25 table football balls standard white

Product code: HB.FB.25White

£ 28.00 excl. VAT
(£ 33.60 incl. VAT)

Do you ever have enough balls for your table football game? Especially if the game is played intensively and regularly, balls can become lost or damaged. Then it is very nice if you can pick up a new ball without thinking and continue playing immediately. With every HeBlad table football table you will receive 6 table football balls for free. This will probably last you for some time, but an extra stock is never a problem. If you order this set of 25 balls directly from your table football table, you will also receive a nice discount on this set of 25 balls. Worth stocking up on.

What are table football balls made of?

The material we use is hard plastic. This ensures that the ball can be used outdoors and that it rolls well on the game table. The balls can also be easily cleaned with dishwashing liquid and warm water.

Delivery of the table football balls

If you order the accessories separately, we will ship your order the day after you place the order. If you ordered the balls together with a table football table, you will receive the balls together with the table.

We usually also deliver complete gaming tables quickly. Because we produce our products ourselves in Hapert, The Netherlands and deliver and install the products ourselves, you don't have to wait long for your products.

Please check the delivery conditions carefully in advance or contact us. This way no one will be faced with unwanted surprises.

3 April 2025 - Prices subject to change

Our products are delivered from our factory in the Netherlands.

Specifications Bag with 25 table football balls standard white

Product code	HB.FB.25White
Material	Kunststof

head office address

HeBlad BV
Diamantweg 22
NL - 5527 LC Hapert

Related products



HB.FB.6White



HB.FB.Handle



HB.FB.Eye.set8



HB.FB.A



HB.FBSC.Green

Our products are delivered from our factory in the Netherlands.



Single football figure available

Product code: HB.FB.DOLL

£ 6.00 excl. VAT
(£ 7.20 incl. VAT)

A game of table football can only be played properly if all players are on the field. Sometimes it happens that one of the football dolls sustains damage or even falls off the bar. You really don't have to replace the entire football table. Order your football doll separately on our website and replace your damaged doll yourself. This way you have a complete table that is ready for the football game.

What is a football doll made of?

Because HeBlad products are intended for outdoor use, the football dolls are also made of unbreakable plastic. They can withstand freezing cold, but also extreme heat. What colours are the football dolls available in? You can choose from 8 different colours for the football dolls: black, white, orange, blue, yellow, red, purple and green. This way you put together your teams yourself, by colour.

Replace multiple football dolls at the same time

Would you like to replace an entire football team in your football table? That's also possible. Then choose the doll set including 2 bumper blocks. Just like the individual dolls, you can choose from different colours here. The sets are designed for rods with a diameter of 16 mm. To make your set even more complete, you also have the option to order a doll set with scoreboard. To replace the dolls, use the supplied Allen key or order the Allen key separately.

When you order accessories from HeBlad, we will ship them immediately the next working day. So you can have your table in order in no time.

Advice and help with replacing football dolls

If you are not convinced of your knowledge to replace the dolls or you need advice, please contact us. We are happy to help you.

3 April 2025 - Prices subject to change

Our products are delivered from our factory in the Netherlands.



correspondence address

HeBlad - UK

The Balance, 7th floor, Pinfold Street
S1 2GU Sheffield, South Yorkshire
T. 0114 352 0110
info@HeBlad.co.uk
www.HeBlad.co.uk

head office address

HeBlad BV

Diamantweg 22
NL - 5527 LC Hapert

[Click here](#) and have a look at the strength of our figures shown in a test.

Our products are delivered from our factory in the Netherlands.

Registered under: HeBlad BV • HM Revenue and Customs • Ruby House 8 • Ruby Place • AB10 1ZP Aberdeen
VAT Number GB381060225 • EORI Number GB381060225000 • Commercial register (NL) 170 66 364
Rabobank De Kempen, Markt 7, 5531 BA Bladel (NL) • BIC RABONL2U • Branch code RABONL2UXXX • IBAN NL 20 RABO 0107530112 GBP

Specifications Single football figure available

Product code	HB.FB.DOLL
Material	Kunststof

head office address

HeBlad BV
Diamantweg 22
NL - 5527 LC Hapert

Related products



HB.FB.A



PP.AR.GR



GT.CH.G2

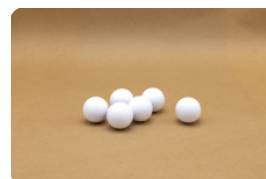

HB.FB.Ball6



HB.FBP.Set

Our products are delivered from our factory in the Netherlands.



Set of football players

Product code: HB.FBP.Set

£ 55.00 excl. VAT
(£ 66.00 incl. VAT)

Does your football team need replacing? No problem! Choose a colour and order 11 new players, including two cushions that are placed on either side of the goalkeeper. By placing new football dolls, your foosball table will be like new again.

Doll set and other accessories

Does your football table squeak and creak a bit, or do you want to give the table a makeover? Then try replacing individual accessories of the table before ordering a completely new football table. Think sustainably and financially attractively, that benefits everyone.

What is needed for a table football game?

In addition to a complete and well-functioning table, players and fun, table footballs are essential. HeBlad supplies six loose balls with each table football table. But we know from experience that these balls often get lost. That is why we offer you these separate balls. You can't have enough in stock. If you order extra balls directly when purchasing your table, you will also receive a nice discount on the balls. This way you are assured of fun playing on your football table for a long time.

Fast delivery football table and doll set

What is the delivery time of the doll set? Because we design and produce everything in-house in Hapert, we can deliver all products and accessories

3 April 2025 - Prices subject to change

Our products are delivered from our factory in the Netherlands.



correspondence address

HeBlad - UK

The Balance, 7th floor, Pinfold Street
S1 2GU Sheffield, South Yorkshire
T. 0114 352 0110
info@HeBlad.co.uk
www.HeBlad.co.uk

head office address

HeBlad BV

Diamantweg 22
NL - 5527 LC Hapert

quickly. For the delivery and installation of the football table, we always refer to our terms of delivery or we ask you to contact us in advance. This way we can be sure that we can place the table correctly and safely on your site.
Click here and have a look at the strength of our figures shown in a test.

Our products are delivered from our factory in the Netherlands.

Registered under: HeBlad BV • HM Revenue and Customs • Ruby House 8 • Ruby Place • AB10 1ZP Aberdeen
VAT Number GB381060225 • EORI Number GB381060225000 • Commercial register (NL) 170 66 364
Rabobank De Kempen, Markt 7, 5531 BA Bladel (NL) • BIC RABONL2U • Branch code RABONL2UXXX • IBAN NL 20 RABO 0107530112 GBP

Specifications Set of football players

Product code	HB.FBP.Set
Material	Kunststof

head office address

HeBlad BV
Diamantweg 22
NL - 5527 LC Hapert

Related products



HB.FB.A



PP.AR.BL

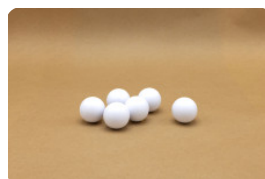

HB.FB.Ball6



HB.FB.Rod



HB.FB.DOLL.Purp

Our products are delivered from our factory in the Netherlands.



Set of kickers with scoreboard

Product code: HB.FBSC.set

£ 79.00 excl. VAT
(£ 94.80 incl. VAT)

How are puppets replaced in a foosball game? The dolls are mounted on a football bar. It is therefore important to carefully disassemble the football bar, including the rubbers and handles. Then you remove the dolls from the rod and you can mount the new dolls. If you want to replace all the dolls in the game, keep a close eye on which rod needs to be replaced where in the game, because all rods have their own hole pattern and length.

Football doll set in different colours

We offer the complete football doll set in eight different colours. So you can put together your own team in colour, completely in the style of your favorite football club or favorite colour. We also offer a scoreboard in the same colour.

What tools are used when replacing a football puppet set? When replacing the football figures, you use a 2.5 mm or 4 mm Allen key. These are included when ordering the football doll set with scoreboard, but you can also order both separately via the website. Which materials can be replaced in a football table?

If during disassembly it turns out that the bars, rubber bumpers, handles or eye protectors also need to be replaced, you can also order these. This way you keep your table tidy and in working order.

Football doll set and other accessories

HeBlad is proud of the quality it delivers. Solid products and strong accessories, all intended for years of fun outdoors. We do not skimp on materials, so we can always supply you with the very best product. Would you like to know more about HeBlad's solid products? Please contact us. We are happy to advise which gaming tables suit you.

3 April 2025 - Prices subject to change

Our products are delivered from our factory in the Netherlands.

Specifications Set of kickers with scoreboard

Product code HB.FBSC.set
Material Kunststof

head office address

HeBlad BV
Diamantweg 22
NL - 5527 LC Hapert

Related products



HB.FB.A



PP.AR.GR

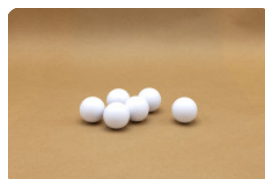

HB.FB.Ball6



HB.FB.DOLL



HB.FB.DOLL.Purp

Our products are delivered from our factory in the Netherlands.



Handle

Product code: HB.FB.Handle

£ 3.00 excl. VAT
(£ 3.60 incl. VAT)

Get a good grip on the table football game with the handles for the football table from HeBlad. These rubber handles are intended to replace damaged or lost handles on the football table. They fit perfectly on the table bars, which have a diameter of 16 mm.

These bars should also be suitable for other football tables, provided the bars have a diameter of 16 mm. If you have any doubts about the suitability of the handles, please contact us.

Order handles

How do you order the handles? You can easily order all accessories for the football table online via the webshop. All parts of the table are available separately, so you can replace them yourself if necessary.

Fun with the football table

HeBlad is known for providing gaming fun and trustworthy products. To hold true to this image, we offer the parts separately for all games that we make. This way you do not have to immediately replace the entire gaming table, but with a small repair you can provide years of outdoor fun again.

Do you have a question about replacing parts or HeBlad products? Contact us or view our offer online.

3 April 2025 - Prices subject to change

Our products are delivered from our factory in the Netherlands.

Specifications Handle

Product code	HB.FB.Handle
Material	Rubber

head office address

HeBlad BV
Diamantweg 22
NL - 5527 LC Hapert

Related products



HB.FB.A



PP.AR.BL

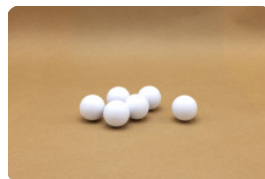

HB.FB.Ball6



HB.FB.DOLL

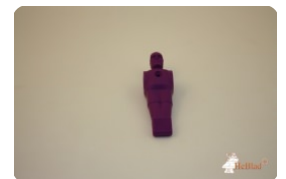

HB.FB.DOLL.Purp

Our products are delivered from our factory in the Netherlands.



Handle, set of 8

Product code: HB.FB.Handleset

£ 20.00 excl. VAT
(£ 24.00 incl. VAT)

3 April 2025 - Prices subject to change

Our products are delivered from our factory in the Netherlands.

Specifications Handle, set of 8

Product code	HB.FB.Handleset
Material	Rubber

head office address

HeBlad BV
Diamantweg 22
NL - 5527 LC Hapert

Related products



HB.FB.A

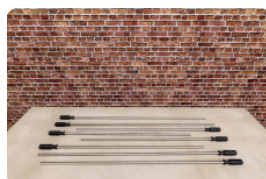

HB.FB.Rodset

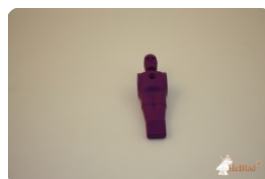

HB.FB.DOLL.Purp



HB.FBSC.Purple



HB.FB.6White

Our products are delivered from our factory in the Netherlands.



Rubber damper

Product code: HB.FB.bumper

£ 2.75 excl. VAT
(£ 3.30 incl. VAT)

Why rubber bumpers? The HeBlad football table is specifically designed for outdoor use, which is why we opted for rubber bumpers instead of the regular metal suspension. Rubber is not sensitive to bad weather conditions. A nice side effect is that the rubber bumpers make less noise.

How are the rubber bumpers replaced?

To replace the rubber bumper, the dolls are rotated from the rod. This can be done with an Allen key size 2.5 mm. The rubbers have a diameter of 15 mm, so that they fit tightly around the rods with a diameter of 16 mm. To replace all rubber bumpers in the football table, you can also order a set of 16 bumpers directly.

Rubber bumper and other accessories

The table football game is played with a hard plastic ball. The other accessories are attached to the table, but these can also be ordered separately.

Questions about replacing rubber bumpers

Do you have questions about replacing the rubber bumpers or other accessories of the football table? Please contact us. No one understands our football table better than we do. We can probably help you remotely to replace the right parts properly.

3 April 2025 - Prices subject to change

Our products are delivered from our factory in the Netherlands.

Specifications Rubber damper

Product code	HB.FB.bumper
Material	Rubber

head office address

HeBlad BV
Diamantweg 22
NL - 5527 LC Hapert

Related products



HB.FB.A



PP.AR.GR

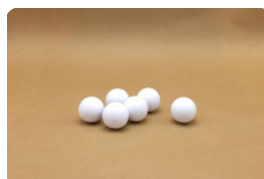

HB.FB.Ball6



HB.FB.DOLL

Our products are delivered from our factory in the Netherlands.



Set of rubber dampers for football table, 16 pcs.

Product code: HB.FB.Bumperset

£ 35.00 excl. VAT
(£ 42.00 incl. VAT)

The HeBlad football table is made up of many different parts and specifically designed for outdoor use. To ensure that you can use your football table at all times, we offer accessories for the table separately.

When to replace rubber bumpers?

You replace these rubber bumpers as soon as they are worn or broken. This ensures that you can continue to play the game properly. The bumpers guide the rods and provide noise reduction while playing. By ordering a set of 16 rubber bumpers, you can immediately provide the entire table with new ones.

A single rubber bumper

Do you think a set of 16 rubber bumpers is too much? Then you can also order the rubber bumpers as single pieces.

How are the bumpers replaced?

When a bumper needs to be replaced, unscrew the plugs from the rods. Use a 2.5 mm Allen key for this.

You can also order the dolls and rods separately from the table. This way you always keep your table complete.

What are the rules of table football?

To play the table football game well, a number of rules are important. For example, the rod may not be rotated completely and the game is played with one ball. Of course it is essential that the table is complete and level.

Contact HeBlad

3 April 2025 - Prices subject to change

Our products are delivered from our factory in the Netherlands.



correspondence address

HeBlad - UK

The Balance, 7th floor, Pinfold Street
S1 2GU Sheffield, South Yorkshire
T. 0114 352 0110
info@HeBlad.co.uk
www.HeBlad.co.uk

head office address

HeBlad BV

Diamantweg 22
NL - 5527 LC Hapert

For all your questions about the game, the table or the accessories, we cordially invite you to contact us.

Our products are delivered from our factory in the Netherlands.

Registered under: HeBlad BV • HM Revenue and Customs • Ruby House 8 • Ruby Place • AB10 1ZP Aberdeen
VAT Number GB381060225 • EORI Number GB381060225000 • Commercial register (NL) 170 66 364
Rabobank De Kempen, Markt 7, 5531 BA Bladel (NL) • BIC RABONL2U • Branch code RABONL2UXXX • IBAN NL 20 RABO 0107530112 GBP

Specifications Set of rubber dampers for football table, 16 pcs.

Product code	HB.FB.Bumperset
Material	Rubber

head office address

HeBlad BV
Diamantweg 22
NL - 5527 LC Hapert

Related products



HB.FB.A



PP.AR.BL



GT.CK.G4

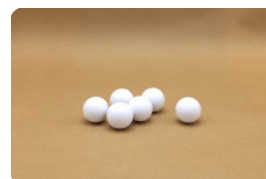

HB.FB.Ball6



HB.FB.DOLL

Our products are delivered from our factory in the Netherlands.



Eye protector for rods

Product code: HB.FB.ey

£ 5.00 excl. VAT
(£ 6.00 incl. VAT)

The so-called eye protectors for the football table are placed on the ends of the rods that protrude from the football table. Why eye protectors? This protection is intended to protect small children from bumping into the bars. These bars are exactly at eye level for them.

A single eye protector

This eye protector is available as a single piece or in a set of 8. Because the football table has 8 bars, a complete set ensures a completely safe table. The end caps are placed on a football table as standard, but you can also order the eye protectors separately.

Which table do the eye protectors fit on?

These eye protectors fit the HeBlad football table, as they have been specifically developed for that. If you have another football table, these caps could also fit. If the rods have a diameter of 16 mm, the caps could be made to fit with a small adjustment. Always contact us first.

Each game table has its own accessories

In addition to eye protectors, HeBlad also has other attributes for the football table that you can order separately. This also applies to the other game tables, each game has its own accessories. You can find which accessories belong to which table on the website or ask one of our employees.

3 April 2025 - Prices subject to change

Our products are delivered from our factory in the Netherlands.

Specifications Eye protector for rods

Product code	HB.FB.eye
Material	Rubber

head office address

HeBlad BV
Diamantweg 22
NL - 5527 LC Hapert

Related products



HB.FB.6White



HB.FBSC.Yellow

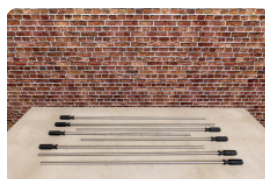

HB.FB.Rodset



HB.FBP.Blue



HB.FB.DOLL.Purp

Our products are delivered from our factory in the Netherlands.



Eye protectors set of 8 pieces.

Product code: HB.FB.Eye.set8

£ 35.00 excl. VAT
(£ 42.00 incl. VAT)

What are eye protectors? These end caps are placed over the parts of the bars that protrude from the football table. Because these bars protrude from the table at eye level for small children, it is important to prevent injury if someone bumps into the bar.

How many eye protectors are needed?

Because the football table has eight rods, one end of which does not have a handle, eight end caps are required. That's why we offer you a set of 8 eye protectors. If you are only missing one end cap, you can also order it in single pieces.

These eye protectors can also be attached to other tables. If the rod has a diameter of 16 mm, a small adjustment will probably be necessary. Please contact us for this. We are happy to help you with the safety around your football table.

Eye protectors and handles

One side of the bar in the football table is now equipped with an eye protector. The other side has a rubber handle. Because both sides have rubber ends, the table is safe to place on playgrounds where many children play.

Where can the football tables be placed?

Because the foosball game is played by four or more people of any age, the table can be placed in many places. Schoolyards, parks, parking lots or in company yards. Would you like to know whether a HeBlad football table is suitable for your site? Please contact us, we will be happy to advise you.

3 April 2025 - Prices subject to change

Our products are delivered from our factory in the Netherlands.



correspondence address

HeBlad - UK

The Balance, 7th floor, Pinfold Street
S1 2GU Sheffield, South Yorkshire
T. 0114 352 0110
info@HeBlad.co.uk
www.HeBlad.co.uk

head office address

HeBlad BV

Diamantweg 22
NL - 5527 LC Hapert

Delivery of the table football balls

If you order the accessories separately, we will ship your order the day after you place the order. If you ordered the balls from a table football table, you will receive the balls together with the table.

We usually also deliver complete gaming tables quickly. Because we produce ourselves in Hapert, The Netherlands, and deliver and install the products ourselves, you never have to wait long on your order.

Please check the delivery conditions carefully in advance or contact us. This way no one will be faced with unwanted surprises.

Our products are delivered from our factory in the Netherlands.

Registered under: HeBlad BV • HM Revenue and Customs • Ruby House 8 • Ruby Place • AB10 1ZP Aberdeen
VAT Number GB381060225 • EORI Number GB381060225000 • Commercial register (NL) 170 66 364

Rabobank De Kempen, Markt 7, 5531 BA Bladel (NL) • BIC RABONL2U • Branch code RABONL2UXXX • IBAN NL 20 RABO 0107530112 GBP

Specifications Eyeprotectors set of 8 pieces.

Product code	HB.FB.Eye.set8
Material	Rubber

head office address

HeBlad BV
Diamantweg 22
NL - 5527 LC Hapert

Related products



HB.FB.6White

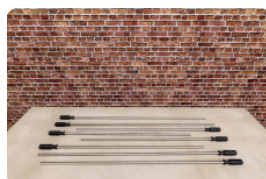

HB.FB.Rodset



HB.FBSC.Yellow

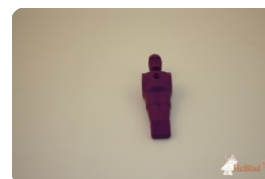

HB.FB.DOLL.Purp



HB.FBP.Blue

Our products are delivered from our factory in the Netherlands.



Table football rod

Product code: HB.FB.Rod

£ 50.00 excl. VAT
(£ 60.00 incl. VAT)

Solid bar of stainless steel 316L for table football. The rod has prepared holes. The rods are not equal in length and number of holes, therefore it is essential to make the right choice.

You also can order a complete set of 8.

3 April 2025 - Prices subject to change

Our products are delivered from our factory in the Netherlands.

Specifications Table football rod

Product code	HB.FB.Rod
Material	Roestvrij staal, rubber

head office address

HeBlad BV
Diamantweg 22
NL - 5527 LC Hapert

Related products



HB.FB.A



PP.R.BL



GT.CK.G4

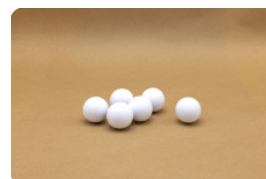

HB.FB.Ball6



HB.FBSC.set

Our products are delivered from our factory in the Netherlands.



Stainless steel rods for football game, set of 8.

Product code: HB.FB.Rodset

£ 375.00 excl. VAT
(£ 450.00 incl. VAT)

Foosball is played on a gaming table equipped with solid stainless steel bars. Each rod has its own layout with holes. The figures are secured here, on each rod in a different place. When replacing the bars, it is essential that the correct bars are placed back in the right place, otherwise the game cannot be played properly. With this set of 8 rods you always have the right rod at hand. If you only want to replace a single rod, you can also choose to order just that one rod. Then make sure you choose the right rod. If in doubt, we advise you to contact us.

How is a football pole replaced?

To replace the football bar, disassemble all figures, handles, rubbers and eye protectors. You do this using an Allen key size 2.5 mm and 4 mm. Of course, assembling the rod is done in reverse order using the same materials. Feel free to ask us to help you replace the rods if you can't figure it out yourself.

Bar set for table football

We supply each football table with all accessories, so you can easily order all parts separately. This means you do not have to immediately replace the entire table. Very sustainable and much less expensive. If you have any questions about the football table or other game tables from HeBlad, you are welcome to contact us. We are happy to tell and advise you about our gaming tables.

3 April 2025 - Prices subject to change

Our products are delivered from our factory in the Netherlands.

Specifications Stainless steel rods for football game, set of 8.

Product code	HB.FB.Rodset
Material	Roestvrij staal, rubber

head office address

HeBlad BV
Diamantweg 22
NL - 5527 LC Hapert

Related products



HB.FB.A



PP.R.GR

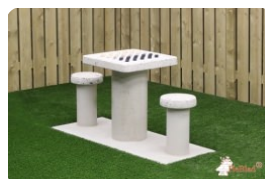

GT.CK.G2



HB.FB.Ball6



HB.FBSC.set

Our products are delivered from our factory in the Netherlands.



correspondence address

HeBlad - UK

The Balance, 7th floor, Pinfold Street
S1 2GU Sheffield, South Yorkshire
T. 0114 352 0110
info@HeBlad.co.uk
www.HeBlad.co.uk

Screw + nut for dolls 30 mm (13)

Product code: FB.S30 set13

£ 4.00 excl. VAT **Head office address**
(£ 4.80 incl. VAT)

HeBlad BV
Diamantweg 22
NL - 5527 LC Hapert

3 April 2025 - Prices subject to change

Our products are delivered from our factory in the Netherlands.

Registered under: HeBlad BV • HM Revenue and Customs • Ruby House 8 • Ruby Place • AB10 1ZP Aberdeen
VAT Number GB381060225 • EORI Number GB381060225000 • Commercial register (NL) 170 66 364
Rabobank De Kempen, Markt 7, 5531 BA Bladel (NL) • BIC RABONL2U • Branch code RABONL2UXXX • IBAN NL 20 RABO 0107530112 GBP

Specifications Screw + nut for dolls 30 mm (13)

Product code

FB.S30 set13

head office address

HeBlad BV
Diamantweg 22
NL - 5527 LC Hapert

Related products

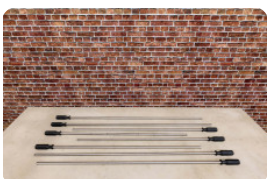

HB.FB.Rodset



HB.FBP.Set



HB.FB.eye



HB.FBP.Set



HB.FBSC.set

Our products are delivered from our factory in the Netherlands.



correspondence address

HeBlad - UK

The Balance, 7th floor, Pinfold Street
S1 2GU Sheffield, South Yorkshire
T. 0114 352 0110
info@HeBlad.co.uk
www.HeBlad.co.uk

Bolts + Nuts eye protectors 35 mm, 8 pieces

Product code: FB.S35 set8

£ 2.50 excl. VAT **Head office address**
(£ 3.00 incl. VAT)

HeBlad BV
Diamantweg 22
NL - 5527 LC Hapert

3 April 2025 - Prices subject to change

Our products are delivered from our factory in the Netherlands.

Registered under: HeBlad BV • HM Revenue and Customs • Ruby House 8 • Ruby Place • AB10 1ZP Aberdeen
VAT Number GB381060225 • EORI Number GB381060225000 • Commercial register (NL) 170 66 364
Rabobank De Kempen, Markt 7, 5531 BA Bladel (NL) • BIC RABONL2U • Branch code RABONL2UXXX • IBAN NL 20 RABO 0107530112 GBP

Specifications Bolts + Nuts eye protectors 35 mm, 8 pieces

Product code

FB.S35 set8

head office address

HeBlad BV
Diamantweg 22
NL - 5527 LC Hapert

Related products



HB.FB.eye



HB.FB.Eye.set8



HB.FB.eye



HB.FB.Eye.set8

Our products are delivered from our factory in the Netherlands.



Universal Base plate for Benches

Product code: OP.BB

£ 1,600.00 excl. VAT
(£ 1,920.00 incl. VAT)

The base plate of 248 x 120 cm is specifically designed to be placed under HeBlad's concrete benches and table football table. These HeBlad products have exactly the right weight to prevent them from sliding on the diamond profile of this base plate.

The base plate is not only suitable for HeBlad products. For example, you can also place this base plate under your own park bench. It is most likely a good idea to anchor the bench in the base plate. For an additional charge, we can even include cutouts in the base plate, so that your bench fits exactly on the base plate. For this we ask you to contact us in advance.

What makes the base plate so special?

In addition to the stability that the base plate guarantees, the ground diamond profile ensures that the plate does not become slippery when exposed to water or moisture. Placing a base plate under your bench protects you from weeds and unwanted growth of grass or moss near the bench. Any grass around the base plate can be mowed easily and neatly, because the plate can easily be placed in the ground at cutting height.

Concrete bench base plate specifications

What are the dimensions of the base plate? With a size of 246 x 120 x 10 cm and a weight of 525 kg, the base plate is quite a solid product. For this reason, the sheet is loaded directly onto the truck from production in our factory in Hapert, the Netherlands, using a loading and unloading crane. It is important to check the delivery conditions in advance, because the truck with crane cannot just arrive on location anywhere.

3 April 2025 - Prices subject to change

Our products are delivered from our factory in the Netherlands.



correspondence address

HeBlad - UK

The Balance, 7th floor, Pinfold Street
S1 2GU Sheffield, South Yorkshire
T. 0114 352 0110
info@HeBlad.co.uk
www.HeBlad.co.uk

head office address

HeBlad BV

Diamantweg 22
NL - 5527 LC Hapert

Bottom plates from HeBlad

All HeBlad products are made with the same strength and cast from one piece of concrete. This may mean that a bottom plate is desirable for stability. Placing a base plate also prevents the ground from collapsing under the game table.

We have designed a special base plate for every HeBlad product. Think of base plates for the ping pong table or a picnic set. In most cases the base plate is optional, you order it separately from the product to be installed. In some cases we have integrated the base plate into the design. This is where the bottom plate is attached. Take the concrete park bench or DeLuxe concrete bench.

Our products are delivered from our factory in the Netherlands.

Registered under: HeBlad BV • HM Revenue and Customs • Ruby House 8 • Ruby Place • AB10 1ZP Aberdeen
VAT Number GB381060225 • EORI Number GB381060225000 • Commercial register (NL) 170 66 364
Rabobank De Kempen, Markt 7, 5531 BA Bladel (NL) • BIC RABONL2U • Branch code RABONL2UXXX • IBAN NL 20 RABO 0107530112 GBP

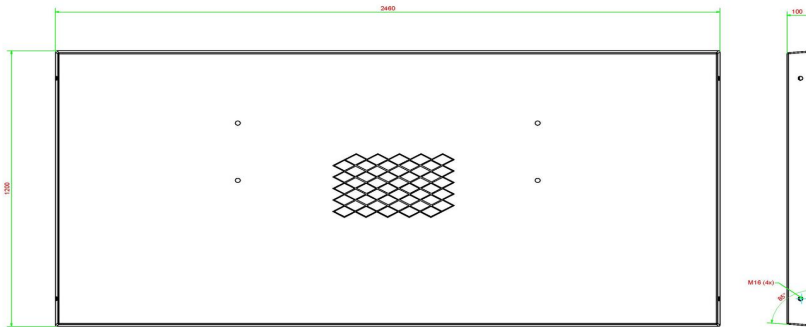

HeBlad
www.HeBlad.com
OP.BB
Gewicht ± 700

Specifications Universal Base plate for Benches

Product code	OP.BB	Weight	525 kg
Colour	Naturel beton	Finishing base plate	Anti-slip (window) profile
Dimensions (L x W x H)	248 x 120 x 7 cm	lifting device	Concrete screw sleeve M16 on 4 sides

Related products



BB.DL.A



BB.DL.OV

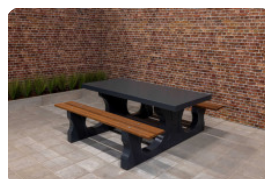

PS.DL.A



HB.FB.A



PP.AR.GR

Our products are delivered from our factory in the Netherlands.



Universa, Base plate for Benches, anthracite-concrete

Product code: OP.BB.AB

£ 1,650.00 excl. VAT
(£ 1,980.00 incl. VAT)

Why a base plate? A base plate provides strength and stability to the bench or football table that is placed on it. Thanks to the diamond profile on the top, slipperiness is prevented in damp weather. Liquid drains into the gutters and the concrete prevents unwanted growth of weeds and the like around the bench. This base plate with dimensions of 246 x 120 x 10 cm is specially made for supporting a HeBlad concrete bench. Because this plate is made of thoroughly coloured anthracite concrete, it fits perfectly with the anthracite oval concrete bench or DeLuxe anthracite concrete bench.

How is the base plate placed?

Due to the weight of 525 kg and the large dimensions, this base plate is delivered with a truck with loading and unloading crane. The reach of the crane is five meters, which means that the installation must be done within five meters of the truck. So always advise our delivery conditions in advance.

The base plate can be placed at cutting height. This makes it easy to keep the area around the plaque tidy. You can mow the lawn without having to cut and sweep without annoying edges.

Which base plate fits best?

At HeBlad we love customization and suitable solutions. That is why we have developed various base plates that match our gaming tables exactly. The base plates for our ping pong tables and picnic sets are also available separately. You can also choose from the colour natural concrete or anthracite concrete. Completely tailored to the product that will be placed on the base plate.

3 April 2025 - Prices subject to change

Our products are delivered from our factory in the Netherlands.



correspondence address

HeBlad - UK

The Balance, 7th floor, Pinfold Street
S1 2GU Sheffield, South Yorkshire
T. 0114 352 0110
info@HeBlad.co.uk
www.HeBlad.co.uk

head office address

HeBlad BV

Diamantweg 22
NL - 5527 LC Hapert

Contact about the anthracite-concrete bench base plate

Do you have any questions about the base plate for the anthracite-concrete bench? Could you use advice on whether or not to install a base plate? Or would you like to know more about HeBlad's other products? Please contact us, we will be happy to help you.

Our products are delivered from our factory in the Netherlands.

Registered under: HeBlad BV • HM Revenue and Customs • Ruby House 8 • Ruby Place • AB10 1ZP Aberdeen
VAT Number GB381060225 • EORI Number GB381060225000 • Commercial register (NL) 170 66 364
Rabobank De Kempen, Markt 7, 5531 BA Bladel (NL) • BIC RABONL2U • Branch code RABONL2UXXX • IBAN NL 20 RABO 0107530112 GBP

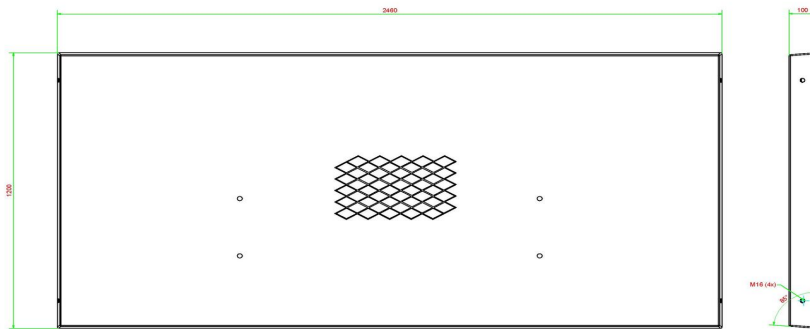

HeBlad
www.HeBlad.com
OP.BB.AB
Gewicht ± 700

Specifications Universa, Base plate for Benches, anthracite-concrete

Product code	OP.BB.AB	Weight	525 kg
Colour	Anthracite concrete	Finishing base plate	Anti-slip (window) profile
Dimensions (L x W x H)	248 x 120 x 7,2 cm	lifting device	Concrete screw sleeve M16 on 4 sides

Related products



OP.BB



OP.PS.AB



BB.ST.A



BB.DLA.ML



BB.DLA.OV

Our products are delivered from our factory in the Netherlands.



Backgammon Bench, Natural Concrete

Product code: BB.BG

£ 2,500.00 excl. VAT
(£ 3,000.00 incl. VAT)

The integrated backgammon game makes this concrete bench a must-have for the garden, the park, the school grounds, the campsite or in the park. HeBlad concrete is specifically designed for years of outdoor use. Intensive use or extreme weather conditions therefore have no effect on the workings or chic appearance of this backgammon bench.

The history of backgammon

Where does backgammon come from? It was most likely first played in Mesopotamia 5000 years ago, after which it evolved over centuries into the current game. It is one of the oldest board games in the world, and the game is still popular with young and older generations.

Backgammon for everyone

The backgammon bench is a beautiful concrete bench whose tabletop contains a backgammon board game. The bench always comes with backgammon stones and five dice. The base plate is optional and may need to be ordered separately.

Combine Backgammon with other gaming tables

This backgammon bench is an eye-catcher in itself but can also be perfectly combined with other game tables or picnic sets from HeBlad. Think of the chess bench or checkers bench in the same colour: natural concrete.

Contact HeBlad

Would you like to know more about our range of backgammon benches? Then be sure to contact us. Our experts are happy to help you.

3 April 2025 - Prices subject to change

Our products are delivered from our factory in the Netherlands.

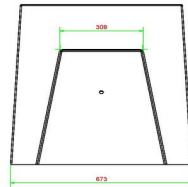
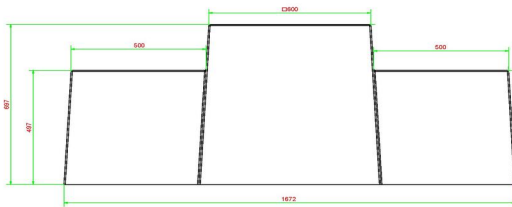
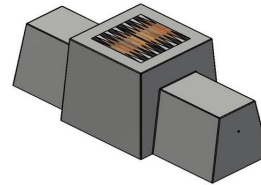
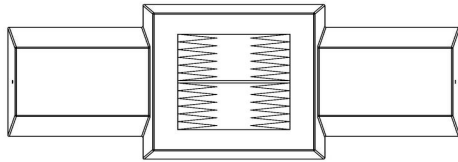

HeBlad
www.HeBlad.com
BB.BG
Gewicht ± 1140 KG.

Specifications Backgammon Bench, Natural Concrete

Product code	BB.BG	Height tabletop	70 cm
Colour	Natural concrete	Weight	1140 kg
Dimensions (L x W x H)	167 x 67 x 70 cm	Number of seats	2
Seat height	50 cm		

Related products



GT.BG.AB2



GT.BG.2

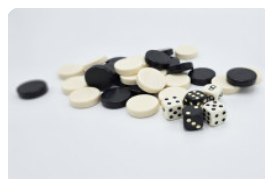

GT.BG.pieces

Our products are delivered from our factory in the Netherlands.



Backgammon Bench, Anthracite-Concrete

Product code: BB.BG.AB

£ 2,575.00 excl. VAT
(£ 3,090.00 incl. VAT)

Dark, robust and multifunctional. This backgammon bench made of anthracite concrete is a true jewel in your garden or in public spaces. How much does the anthracite concrete backgammon bench cost? You will not find a product of this high quality for a better price. At HeBlad, you order directly from the supplier and manufacturer, which saves in cost and emission.

Did you know that you always automatically receive an extra discount when you order multiple HeBlad products? That is more than worth the effort to combine our products. How about a regular concrete bench or a beautiful chess bench in anthracite concrete colour?

Backgammon bank from HeBlad

Like all HeBlad products, this backgammon bench is also made from a single piece of concrete. Insensitive to vandalism and weather influences. Because the colour anthracite is added to the concrete, the entire bench is this beautiful anthracite colour, including the inside of the product. In the unlikely event of damage, the bench will not lose its colour. Thanks to their massive weight, HeBlad backgammon banks are also impervious to theft and vandalism. By placing the bank in a strategic location, even ram raids can be prevented or you will have a perfect and sturdy separation of your site.

Delivery of the backgammon bench

We produce and supply this backgammon bank in-house. That is why we always advise you to read the delivery conditions in advance. We work with short delivery times of averagely 6 working weeks and with a loading and unloading crane from our own truck. The backgammon bank is always supplied including the backgammon stones and five dice. A possible base plate is always optional. You

3 April 2025 - Prices subject to change

Our products are delivered from our factory in the Netherlands.



correspondence address

HeBlad - UK

The Balance, 7th floor, Pinfold Street
S1 2GU Sheffield, South Yorkshire
T. 0114 352 0110
info@HeBlad.co.uk
www.HeBlad.co.uk

head office address

HeBlad BV

Diamantweg 22
NL - 5527 LC Hapert

can contact us about this and order the base plate separately, if desired.

Our products are delivered from our factory in the Netherlands.

Registered under: HeBlad BV • HM Revenue and Customs • Ruby House 8 • Ruby Place • AB10 1ZP Aberdeen
VAT Number GB381060225 • EORI Number GB381060225000 • Commercial register (NL) 170 66 364
Rabobank De Kempen, Markt 7, 5531 BA Bladel (NL) • BIC RABONL2U • Branch code RABONL2UXXX • IBAN NL 20 RABO 0107530112 GBP

Specifications Backgammon Bench, Anthracite-Concrete

Product code	BB.BG.AB	Height tabletop	70 cm
Colour	Anthracite concrete	Weight	1140 kg
Dimensions (L x W x H)	167 x 67 x 70 cm	Number of seats	2
Seat height	50 cm		

head office address

HeBlad BV
Diamantweg 22
NL 6527 LC Hapert

Related products



BB.BG



BB.CK.AB

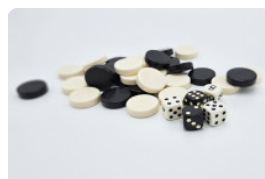

GT.BG.pieces

Our products are delivered from our factory in the Netherlands.



Checkers/Drafts Table Natural Concrete (2P)

Product code: GT.CK.2

£ 3,150.00 excl. VAT
(£ 3,780.00 incl. VAT)

Would you like to take on the challenge of a game of the mind? The natural 2-person concrete checkers table offers the opportunity to compete with your opponent in the open air.

A chic and sleek version that doesn't look out of place anywhere. Do you have space in your garden? Or would you rather place the checkers table in a city park or on a schoolyard? Every outdoor space brightens up when this checker bank is part of it.

The weather-resistant concrete checkers table

The beautiful natural colour of the checkers table natural concrete for 2 people gives a natural look to the table and seats. The integrated checkerboard, like the entire checkers table, is easy to keep clean and resistant to all weather influences. The free checkers tiles provided are also made for the outdoors, so enjoy a game of checkers in the open air.

Concrete game table in various designs

Because tastes differ, the natural concrete checkers table for 2 persons can also be supplied as an anthracite-concrete checkers table for 2 persons. With the same appearance and specifications, but made from anthracite coloured concrete.

Have you already taken a look at the natural concrete checkers bank or the anthracite concrete checkers bank? You can play the same fun checkers game on these, only these benches are more robust.

3 April 2025 - Prices subject to change

Our products are delivered from our factory in the Netherlands.



correspondence address

HeBlad - UK

The Balance, 7th floor, Pinfold Street
S1 2GU Sheffield, South Yorkshire
T. 0114 352 0110
info@HeBlad.co.uk
www.HeBlad.co.uk

head office address

HeBlad BV

Diamantweg 22
NL - 5527 LC Hapert

Combine the concrete checkers table with other games and gaming tables

Of course, it is fantastic to offer physical games to the users of your outdoor area in addition to mind sports. Combine the concrete checkers table natural concrete for 2 persons with one of the other game tables from HeBlad. Have you ever looked at the beautiful ping pong tables? How about the trendy foot volleyball or the always fanatical table football?

Supply and installation of concrete gaming tables

Because all HeBlad products are made to be placed on outdoor areas, they are all made of concrete. These are heavy materials that require specific delivery and installation. We advise you to always contact HeBlad professionals to discuss the options for installation on your site and to make the correct preparations if necessary.

*When you order a checkers table, you will receive 1 set of checkers for free.

Our products are delivered from our factory in the Netherlands.

Registered under: HeBlad BV • HM Revenue and Customs • Ruby House 8 • Ruby Place • AB10 1ZP Aberdeen
VAT Number GB381060225 • EORI Number GB381060225000 • Commercial register (NL) 170 66 364

Rabobank De Kempen, Markt 7, 5531 BA Bladel (NL) • BIC RABONL2U • Branch code RABONL2UXXX • IBAN NL 20 RABO 0107530112 GBP

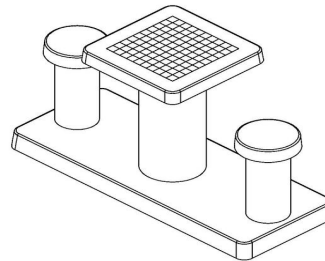
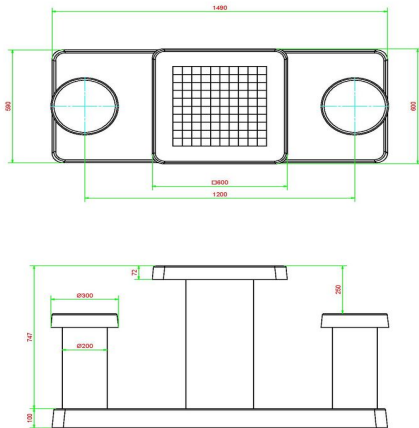

HeBlad
www.HeBlad.com
GT.CK.2
Gewicht ± 490 KG.

Specifications Checkers/Drafts Table Natural Concrete (2P)

Product code	GT.CK.2	Height tabletop	75 cm
Colour	Natural concrete	Seat height	50 cm
Dimensions (L x W x H)	149 x 59 x 85 cm	Dimensions base plate (L x W x H)	160 x 10 x 10 cm
Dimensions tabletop (L x W)	60 x 60 cm	Weight	425 kg
Tabletop thickness	7 cm		

Related products



GT.CK.AB2



GT.CH.4



BB.CK



GT.CK.Pieces



PS.DLAB.GT.132

Our products are delivered from our factory in the Netherlands.



Checkers/Drafts Table Anthracite-Concrete (2P)

Product code: GT.CK.AB2

£ 3,250.00 excl. VAT
(£ 3,900.00 incl. VAT)

Slim, subtle but sturdy. This checkers table in anthracite concrete is made for two people. The table is equipped with an integrated checkers game and you will receive the necessary set of checkers free of charge. Because the height of the table is 75 cm, it is perfectly matched to the height of the seats of 50 cm. These are standard seat and table heights, so you can sit comfortably to play checkers or just have a chat. Would you rather play chess than checkers? This checkers table can also be ordered as an anthracite concrete chess table for 2 persons. Don't forget to check out HeBlad's other gaming tables and benches.

Checkers table for 2 or 4 persons

If you have the space or would prefer to have four seats around the table, then the anthracite concrete checkers table for 4 people is perfect for your location. This has the same beautiful anthracite colour, but has four seating options. The corresponding bottom plate for the checkers and chess tables is adapted to the surface of the table with seats. Take this into account when determining whether a 4-person checkers table is suitable for your site. Both the 2-person and 4-person tables are available in natural concrete. The checkers table natural concrete for 2 persons is, as the name suggests, made of concrete and is of the same high quality as the anthracite version.

Combine the checkers table with other game tables

Because HeBlad products are known for their strength and retention of their beautiful appearance, you can confidently combine existing HeBlad products with new ones. For example, do you already have a HeBlad ping pong table on your property? Then a completely new checkers table would not look out of place next

3 April 2025 - Prices subject to change

Our products are delivered from our factory in the Netherlands.



correspondence address

HeBlad - UK

The Balance, 7th floor, Pinfold Street
S1 2GU Sheffield, South Yorkshire
T. 0114 352 0110
info@HeBlad.co.uk
www.HeBlad.co.uk

head office address

HeBlad BV

Diamantweg 22
NL - 5527 LC Hapert

to this ping pong table. All products are cast from concrete and are insensitive to extreme weather conditions and vandalism. Do you want to expand your game tables with a nice picnic set or do you want to install a concrete bench as an extension to your foot volleyball table? If you have the space, nothing should hold you back. Contact us and we will discuss your options.

Our products are delivered from our factory in the Netherlands.

Registered under: HeBlad BV • HM Revenue and Customs • Ruby House 8 • Ruby Place • AB10 1ZP Aberdeen
VAT Number GB381060225 • EORI Number GB381060225000 • Commercial register (NL) 170 66 364
Rabobank De Kempen, Markt 7, 5531 BA Bladel (NL) • BIC RABONL2U • Branch code RABONL2UXXX • IBAN NL 20 RABO 0107530112 GBP

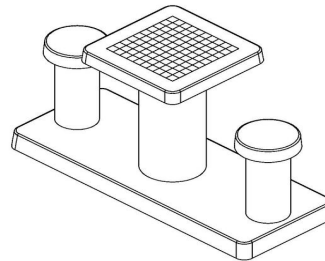
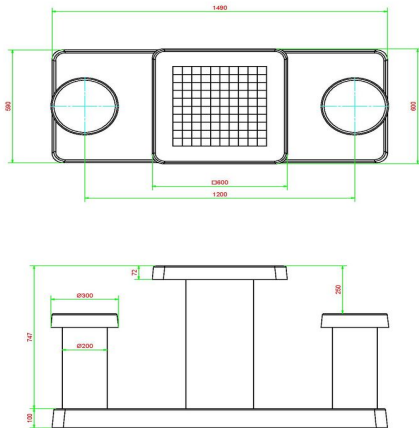

HeBlad
www.HeBlad.com
GT.CK.AB2
Gewicht ± 490 KG.

Specifications Checkers/Drafts Table Anthracite-Concrete (2P)

Product code	GT.CK.AB2	Height tabletop	75 cm
Colour	Anthracite concrete	Seat height	50 cm
Dimensions (L x W x H)	149 x 59 x 85 cm	Dimensions base plate (L x W x H)	1200 x 60 x 10 cm
Dimensions tabletop (L x W)	60 x 60 cm	Weight	425 kg
Tabletop thickness	7 cm		

Related products

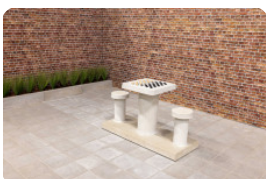

GT.CK.2



GT.CH.AB4



BB.CK



GT.CK.Pieces



PS.DL.GT.132

Our products are delivered from our factory in the Netherlands.



Ludo Game Table Naturel Concrete (4P)

Product code: GT.LD.4

£ 3,500.00 excl. VAT
(£ 4,200.00 incl. VAT)

A real showpiece for the schoolyard or playground, for example. Enjoy a fun game of 'Ludo' or simply have lunch together at this game table. These game tables consist of one piece of concrete. So there are no loose parts, which optimizes safety. The playing surfaces are made of natural stone. The table is resistant to all weather influences. You are guaranteed years of enjoyment when you buy a HeBlad gaming table.

High quality Ludo game tables

At HeBlad we use special high-quality concrete. All our products are of high quality, as you have come to expect from us. The Ludo game table therefore retains its functionality for a long time, which means guaranteed years of fun. The playing surface of the Ludo game table is made of natural stone and is therefore resistant to all weather influences.

Choose the gaming table variant that suits you

The Ludo game table is available in two colours; Anthracite Concrete and Natural Concrete. In addition, HeBlad's game tables are also available in Chess table, Checkers table or Backgammon game table. When ordering this Ludo game table, you also have the choice of whether you want two or four seats. The concrete Ludo game table is a very popular product. The Ludo game table is not only a favorite on Dutch playgrounds and schoolyards, but also abroad.

Concrete base plate for game tables

3 April 2025 - Prices subject to change

Our products are delivered from our factory in the Netherlands.



correspondence address

HeBlad - UK
The Balance, 7th floor, Pinfold Street
S1 2GU Sheffield, South Yorkshire
T. 0114 352 0110
info@HeBlad.co.uk
www.HeBlad.co.uk

head office address

HeBlad BV
Diamantweg 22
NL - 5527 LC Hapert

The base plate of the Ludo game table is placed at the same height as the existing paving. This means no steps up or down. The concrete base plate makes maintenance around the gaming tables easier. The bottom plate also ensures that the Ludo game table remains stable. Robust and solid, as you have come to expect from HeBlad.

Questions about our concrete game tables?

Do you have any questions about this Ludo game table or one of our other products? Please take a look at our FAQs (frequently asked questions) or contact us, we will be happy to help you.

*When you order this game tile you will receive 1 set of pawns and dice for free.

Our products are delivered from our factory in the Netherlands.

Registered under: HeBlad BV • HM Revenue and Customs • Ruby House 8 • Ruby Place • AB10 1ZP Aberdeen
VAT Number GB381060225 • EORI Number GB381060225000 • Commercial register (NL) 170 66 364
Rabobank De Kempen, Markt 7, 5531 BA Bladel (NL) • BIC RABONL2U • Branch code RABONL2UXXX • IBAN NL 20 RABO 0107530112 GBP

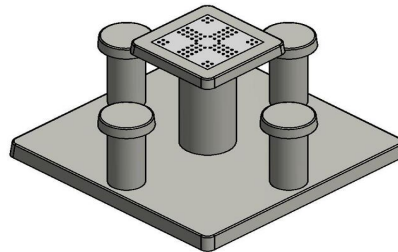
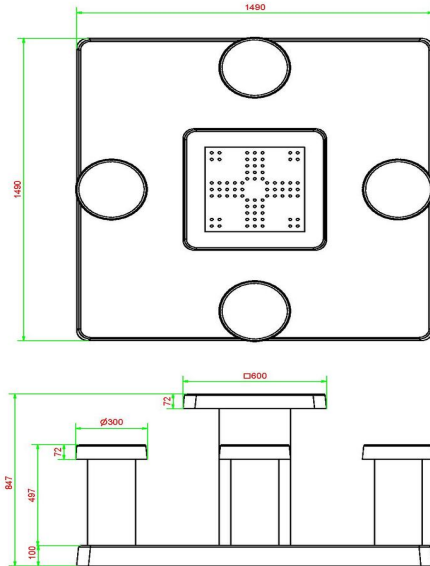

HeBlad
www.HeBlad.com
GT.LD.4

± 900 KG.

Specifications Ludo Game Table Naturel Concrete (4P)

Product code	GT.LD.4	Height tabletop	75 cm
Colour	Natural concrete	Seat height	50 cm
Dimensions (L x W x H)	149 x 149 x 85 cm	Dimensions base plate (L x W x H)	149 x 149 x 10 cm
Dimensions tabletop (L x W)	60 x 60 cm	Weight	900 kg
Tabletop thickness	7 cm		

Related products



GT.CH.AB4

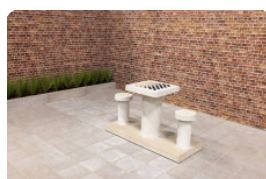

GT.CK.2



BB.CH.AB



GT.LD.instore

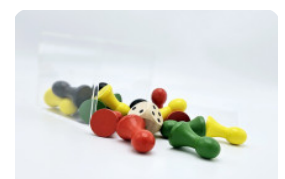

GT.LD.Pieces

Our products are delivered from our factory in the Netherlands.



Ludo Game Table Anthracite-Concrete (4P)

Product code: GT.LD.AB4

£ 3,600.00 excl. VAT
(£ 4,320.00 incl. VAT)

What a beauty, this anthracite concrete ludo table. The square game table top in combination with the round leg and round seats makes the design unique. The integrated game board has bright ludo colours, making the table a real eye-catcher on your schoolyard, in the park, in the garden or on your camping site. The four stools are perfectly adjusted to the table height, have the ideal seat height and the perfect distance to the game. This well-coordinated height also makes the anthracite concrete ludo table very suitable as a regular garden table.

No need to worry about the anthracite concrete ludo table

Due to the robust and incredibly sturdy concrete from which the stools and table are made, you never have to worry about wear and tear on the anthracite concrete ludo table. Weather-resistant, easy to maintain and impervious to vandalism. The game board consists of natural stone and is incorporated into the concrete of the table top. The pawn set with dice that you receive for free from HeBlad is also made of high-quality material. If you accidentally lose them, you can simply order a new or extra set.

An infinity of gaming tables from HeBlad

In addition to the anthracite concrete ludo table, HeBlad also has the natural concrete ludo table variant. In terms of colour, this is the lighter version of the anthracite concrete table. Several ludo tables can also be placed together, in the same or different colours.

By combining different gaming tables you broaden the gaming options for your visitors. For the athletes, foot volleyball is a fitting challenge and the familiar ping

3 April 2025 - Prices subject to change

Our products are delivered from our factory in the Netherlands.



correspondence address

HeBlad - UK

The Balance, 7th floor, Pinfold Street
S1 2GU Sheffield, South Yorkshire
T. 0114 352 0110
info@HeBlad.co.uk
www.HeBlad.co.uk

head office address

HeBlad BV

Diamantweg 22
NL - 5527 LC Hapert

pong tables are always a success.

Additional seating next to the anthracite concrete ludo table

Perhaps your accommodation would benefit more from extra space to sit in addition to playing the ludo game. Recreational enthusiasts and hikers will certainly appreciate a beautiful picnic set and the benches from HeBlad are so sturdy that they can also keep your site safe.

Contact HeBlad

Are overwhelmed with all the possibilities and not sure what the best option is for your site? Please contact HeBlad, we will be happy to help you.

*When you order this game tile you will receive 1 set of pawns and dice for free.

Our products are delivered from our factory in the Netherlands.

Registered under: HeBlad BV • HM Revenue and Customs • Ruby House 8 • Ruby Place • AB10 1ZP Aberdeen
VAT Number GB381060225 • EORI Number GB381060225000 • Commercial register (NL) 170 66 364
Rabobank De Kempen, Markt 7, 5531 BA Bladel (NL) • BIC RABONL2U • Branch code RABONL2UXXX • IBAN NL 20 RABO 0107530112 GBP

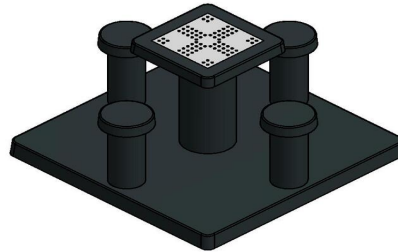
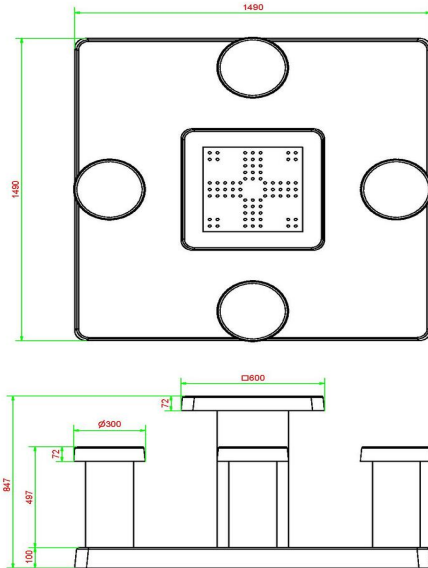

HeBlad
www.HeBlad.com
GT.LD.AB4

± 900 KG.

Specifications Ludo Game Table Anthracite-Concrete (4P)

Product code	GT.LD.AB4	Height tabletop	75 cm
Colour	Anthracite concrete	Seat height	50 cm
Dimensions (L x W x H)	149 x 149 x 85 cm	Dimensions base plate (L x W x H)	149 x 149 x 10 cm
Dimensions tabletop (L x W)	60 x 60 cm	Weight	900 kg
Tabletop thickness	7 cm		

Related products



BB.CH

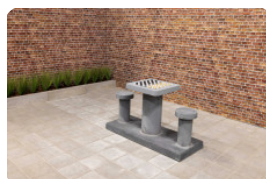

GT.CK.AB2



GT.CH.4



GT.LD.instort

Our products are delivered from our factory in the Netherlands.



Multi-Game Table (1-1-1) Standard

Product code: PS.ST.GT.111

£ 3,750.00 excl. VAT
(£ 4,500.00 incl. VAT)

What do the numbers 1-1-1 mean in this picnic set? We produce several variants of the multi-game tables. Because of this, we have numbered the games. 1 symbolises chess in the HeBlad tables. This multi-game table 1-1-1 is thus equipped with three chess boards. How are the game boards attached? The game boards are integrated into the concrete table top of the picnic set. They are impossible to pry loose without the right equipment. We've designed the table so that there is no annoying edge or ridge around the game boards; they are perfectly level with the rest of the table. This multi-gaming table is perfect for playing chess, impervious to vandalism and very easy to keep clean.

Multifunctional multi-games table

Because the game boards integrate so neatly into the table top, the set can also be used when not being played. With the ideal seat and table top height, this multi-games table is a perfect picnic set. The multi-game table 1-1-1 comes with three sets of chess pieces for free. But when chess is not being played, you have an extremely solid picnic set on your property.

Where are the multi-game tables?

You will encounter HeBlad products throughout Europe and even beyond. The multi-game tables are often placed at campsites, in parks and on schoolyards. But also on industrial estates and at private homes. If your location is difficult to reach or you are unsure about the space you have to place the set, please contact us first or read the delivery conditions carefully. Our products are large and heavy and cannot be placed just anywhere. But of course we will think along with you and look for what is possible.

3 April 2025 - Prices subject to change

Our products are delivered from our factory in the Netherlands.

Specifications Multi-Game Table (1-1-1) Standard

head office address

Product code	PS.ST.GT.111	Height tabletop	75 cm	HeBlad BV
Colour	Natural concrete	Seat height	50 cm	Diamantweg 22
Dimensions (L x W x H)	210 x 193 x 75 cm	Material seat	Beton	NL - 5527 LC Hapert
Dimensions tabletop (L x W)	210 x 90 cm	Distance legs	111 cm (center to center)	
Tabletop thickness	7 cm	Weight	950 kg	

Related products



PS.ST.GT.132



PS.STAB.GT.132



GT.CH.Pieces



BB.CH.AB



GT.CH.2

Our products are delivered from our factory in the Netherlands.



Multi Gaming table (1-1-1) Standard Anthracite-concrete

Product code: PS.STAB.GT.111

This beautiful games table has multiple functions. In addition to being a wonderful picnic set that can easily seat six people, three couples can play a game of chess at the table. If a full chess table doesn't suit your tastes, you can choose which game boards you want in your games table. View our range of Multi-Games Tables for other variants with different games.

What do the numbers in the Multi-Games Table mean?

What does Multi 1-1-1 mean? Multi refers to multiple games, in the case of this games table it means three chess games. The number 1 stands for chess.

Meaning of the numbers:

- 1- Chess game
- 2- Checkers game
- 3- Ludo game
- 4- Backgammon

You can also choose to have other games placed in this table as desired. You can decide the order of the games yourself. We cast the game boards into the table top ourselves, so that you do not have to worry about raised edges on the table and are ensured that the boards remain securely in place (against vandalism or theft). If you wish to change the order of the games in your chosen Multi-Game Table, please always contact us first.

Multi-Games table accessories

Is the games table supplied with chess pieces? All games tables at HeBlad are supplied with matching accessories such as pawns, checkers, chess pieces or chips as standard. You can also order the accessories separately if something is

£ 3,900.00 excl. VAT
(£ 4,680.00 incl. VAT)

3 April 2025 - Prices subject to change

Our products are delivered from our factory in the Netherlands.



correspondence address

HeBlad - UK

The Balance, 7th floor, Pinfold Street
S1 2GU Sheffield, South Yorkshire
T. 0114 352 0110
info@HeBlad.co.uk
www.HeBlad.co.uk

head office address

HeBlad BV

Diamantweg 22
NL - 5527 LC Hapert

lost or broken.

Picnic set

Without the game pieces nearby, the table can be used as a picnic set. Would you rather not have games integrated into the table top? Then make your choice from our range of picnic sets. You are then opting for sturdiness, comfort and elegance. The picnic sets are available in various colours, shapes and sizes. We even make wheelchair-accessible picnic sets.

Concrete game tables, picnic sets and benches from HeBlad

Most people know us from the popular ping-pong table. HeBlad products are known for their long lifespan. Thanks to the solid concrete and robust construction, you are always assured of years of sitting and playing pleasure. Our products are also easy to combine. The concrete benches from HeBlad are perfect to place with the other gaming tables from HeBlad. They are practical, look good on your terrain and offer security. The benches can be used very well as a separation, but also as protection against ram raids.

Our products are delivered from our factory in the Netherlands.

Registered under: HeBlad BV • HM Revenue and Customs • Ruby House 8 • Ruby Place • AB10 1ZP Aberdeen
VAT Number GB381060225 • EORI Number GB381060225000 • Commercial register (NL) 170 66 364

Rabobank De Kempen, Markt 7, 5531 BA Bladel (NL) • BIC RABONL2U • Branch code RABONL2UXXX • IBAN NL 20 RABO 0107530112 GBP

Specifications Multi Gaming table (1-1-1) Standard Anthracite-concrete

head office address

Product code	PS.STAB.GT.111	Height tabletop	75 cm	HeBlad BV
Colour	Anthracite concrete	Seat height	50 cm	Diamantweg 22
Dimensions (L x W x H)	210 x 193 x 75 cm	Material seat	Beton	NL - 5527 LC Hapert
Dimensions tabletop (L x W)	210 x 90 cm	Distance legs	111 cm (center to center)	
Tabletop thickness	7 cm	Weight	950 kg	

Related products



PS.DL.GT.111



PS.ST.GT.132



OP.PS.AB



GT.CH.Pieces

Our products are delivered from our factory in the Netherlands.



Multi Gaming table (1-1-1) DeLuxe

Product code: PS.DL.GT.111

£ 3,900.00 excl. VAT
(£ 4,680.00 incl. VAT)

This multi-game table is equipped with three chess games as standard. This spacious chess table is also available in anthracite concrete. You can also choose other games at the games table. You can even choose which game sheet you want collapsed in which place. So would you prefer a different layout? Please contact us. In addition to the chess game, choose from the Checkers game or Ludo game.

Explanation of our codes:

- 1 = Chess game
- 2 = Checkers game
- 3 = Ludo game
- 4 = Backgammon game

Game tables

In the meantime, there are many HeBlad game tables already outdoors. This encourages young and old to spend more time outside. At the same time, playing games together outdoors is very good for (new) social contacts. The HeBlad game tables are available in different designs. This is equipped with three chess boards, there is room for 6 chess players. This chess table fits perfectly in a public space such as a playground, park or on a walking route. We also increasingly see a chess or checkers table on the schoolyard.

Custom gaming tables

This game table with chess boards is made in the colour Natural Concrete. We also offer this game table in the colour Anthracite concrete. Moreover, you can also choose which game sheet you want to have collapsed in which place. You can choose from four game sheets: chess, checkers, ludo and backgammon.

3 April 2025 - Prices subject to change

Our products are delivered from our factory in the Netherlands.



correspondence address

HeBlad - UK

The Balance, 7th floor, Pinfold Street
S1 2GU Sheffield, South Yorkshire
T. 0114 352 0110
info@HeBlad.co.uk
www.HeBlad.co.uk

head office address

HeBlad BV

Diamantweg 22
NL - 5527 LC Hapert

Would you prefer a different layout? Please feel free to contact us. We are happy to help you.

Top quality gaming tables

Our game tables, like other HeBlad products, are also cast from one piece of concrete. The entire game table is therefore a solid piece of concrete and cannot be dismantled. High-quality concrete, as you have come to expect from us. This way you limit the risk of damage, whether intentional or not. The chess table can remain usable for a long time and you will have years of fun with the HeBlad game table.

Combine chess table with another game table

You can easily combine different products from our collection to decorate a larger outdoor space. For example, consider a ping pong table or foot volleyball table for active fun. With an extra picnic table or bench, there is something for everyone and you create an attractive place to get together.

Order chess table with chess set easily online

When you purchase game tables, you will receive one set of chess pieces per chess board. This allows you to start enjoying your gaming tables straight away. Are you interested in the HeBlad gaming tables? Then order your gaming table easily, quickly and safely on our website. The offer is varied. You will immediately see the price of your order.

Accessories for chess table and other game tables

We always supply the necessary accessories with every game and gaming table. With this chess table you will receive the necessary chess pieces. These, just like the checkers and pawns, are made of wood. Only the stones for the backgammon game are made of plastic.

Contact

Do you have any questions about our products or service or would you like any advice? Our team is ready to assist you. Please feel free to contact us so we can assist you. We are of course happy to think along with you.

Our products are delivered from our factory in the Netherlands.

Registered under: HeBlad BV • HM Revenue and Customs • Ruby House 8 • Ruby Place • AB10 1ZP Aberdeen
VAT Number GB381060225 • EORI Number GB381060225000 • Commercial register (NL) 170 66 364

Rabobank De Kempen, Markt 7, 5531 BA Bladel (NL) • BIC RABONL2U • Branch code RABONL2UXXX • IBAN NL 20 RABO 0107530112 GBP

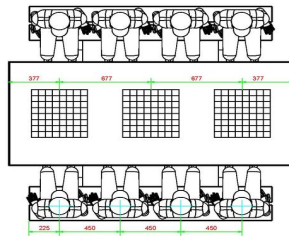
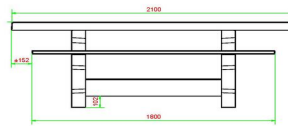
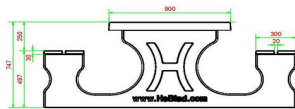
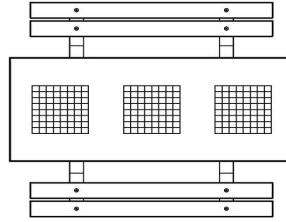
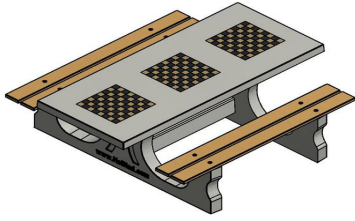

HeBlad
www.HeBlad.com
PS.DL.GT.111
± 780 KG.

Specifications Multi Gaming table (1-1-1) DeLuxe

Product code	PS.DL.GT.111	Height tabletop	75 cm
Colour	Natural concrete	Seat height	50 cm
Dimensions (L x W x H)	210 x 193 x 75 cm	Material seat	Bamboo
Dimensions tabletop (L x W)	210 x 90 cm	Distance legs	111 cm (center to center)
Tabletop thickness	7 cm	Weight	780 kg

Related products



PS.ST.GT.111



PS.STAB.GT.111



GT.CH.Pieces

Our products are delivered from our factory in the Netherlands.

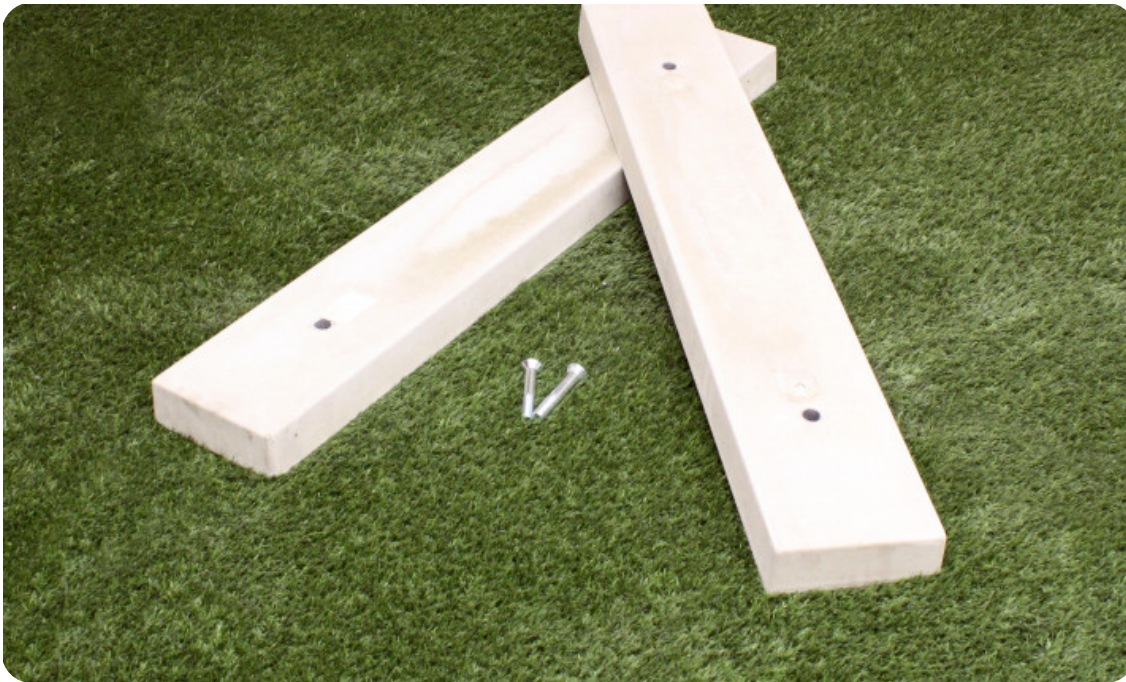

A set of support blocks for different tables

Product code: OV.PP.SET

£ 100.00 excl. VAT
(£ 120.00 incl. VAT)

To better distribute the pressure of HeBlad's robust gaming tables and to prevent the table from sinking into the underlying surface, we have developed bottom feet. The size of each piece in the set is 122.5 x 20 x 6.5 cm and they are therefore suitable for our ping pong tables, foot volleyball tables and table football tables. Because the bottom feet are wider than the legs of the tables, they are less likely to sink into the ground on which they stand. The bottom feet are easy to mount on the bottom of the legs and are made from the well-known sturdy HeBlad concrete.

Set of base feet or base plate

Because our ping pong tables are heavy products, the set of bottom feet may not be sufficient for your surface to prevent collapse. We have devised complete base plates for this purpose, which fit perfectly under our ping-pong tables. By using the base plate you strengthen the surface and protect the ping pong table against unwanted grass or weeds.

If you are unsure about the best solution for you, please contact us. Free delivery applies to both the base set and the base plate in the Netherlands and the average delivery time is only 10 working days. For the UK, this will take a bit longer. On average the delivery time is 6 weeks.

More possibilities with a set of lower feet

Because the set of bases is suitable for several HeBlad gaming tables, you no longer have to worry whether the surface of your location is suitable for a foot volleyball table. This set also makes it possible for you to finally install that football table. Feel free to order the long-cherished ping pong table. Nothing is holding you back anymore.

3 April 2025 - Prices subject to change

Our products are delivered from our factory in the Netherlands.



correspondence address

HeBlad - UK

The Balance, 7th floor, Pinfold Street
S1 2GU Sheffield, South Yorkshire
T. 0114 352 0110
info@HeBlad.co.uk
www.HeBlad.co.uk

head office address

HeBlad BV

Diamantweg 22
NL - 5527 LC Hapert

Contact HeBlad

We'd like to offer everyone a suitable gaming table, picnic set or concrete bench from HeBlad. That is why we are constantly developing and listening to you. By producing the set of base feet and the base plates, more locations have the opportunity to install HeBlad products. Are you curious about our products and would you like to know what is possible in your area? Feel free to contact us.

Our products are delivered from our factory in the Netherlands.

Registered under: HeBlad BV • HM Revenue and Customs • Ruby House 8 • Ruby Place • AB10 1ZP Aberdeen
VAT Number GB381060225 • EORI Number GB381060225000 • Commercial register (NL) 170 66 364
Rabobank De Kempen, Markt 7, 5531 BA Bladel (NL) • BIC RABONL2U • Branch code RABONL2UXXX • IBAN NL 20 RABO 0107530112 GBP

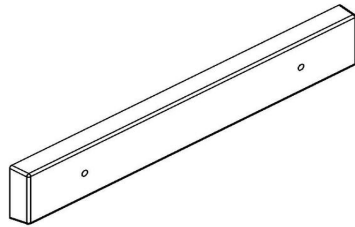
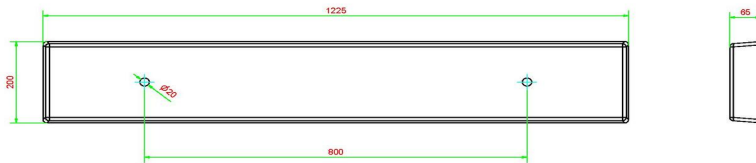

HeBlad
www.HeBlad.com
OV.PP.SET
Gewicht ± 38 KG.
(geleverd per twee)

Specifications A set of support blocks for different tables

Product code	OV.PP.SET
Weight	38 kg

Related products



PS.DL.A



PP.GR



PS.DLAB.RT



PP.AR.BL



PP.R.AB

Our products are delivered from our factory in the Netherlands.

Anthracite-Concrete Base Set for various tables

Product code: OVAB.PP.SET

The weight of the HeBlad game tables is high. Solidity, robustness and resistance to vandalism ensure that the tables last for years and retain their beautiful appearance. However, this can mean that the heavy ping-pong tables, footvolley tables or football tables sink on certain surfaces. How do you prevent such a heavy product from sinking? By placing a base set under the table legs of the tables, more surface area is created and thus the weight of the table is distributed more nicely.

Specifications base set anthracite concrete

This base set is made of anthracite concrete through and through, exactly the same colour anthracite concrete as our game tables are made of. The dimensions of a base piece are 122.5 x 20 x 6.5 cm. As a result, the base protrudes 5 cm all around beyond the original table leg. In what colour are the base sets available? Because we always work with robust concrete and we colour the concrete in its entirety, you can choose between anthracite concrete and natural concrete. For the game tables in the colour natural concrete, you order the set of concrete base pieces for extra load-bearing capacity. With the same properties and specifications, but in a different colour. The right base set for every table.

Base set or base plate

A base set is an inconspicuous aid to provide stability to the gaming table. What if the surface is too soft or uneven? Then play it safe and place the table on a base plate. We have developed a suitable base plate specifically for all gaming tables. This plate can be placed in the surface, so that there are no annoying raised edges, mowing the lawn around the table is no problem and the table is level.

Contact HeBlad about the base set

When do you choose a base set and when is a base plate recommended? Or can the gaming table be placed directly on the surface? We understand that in some cases it is difficult to determine what the best option is. Therefore, if in doubt, always contact us. We are happy to help you with the right advice and explain all the options to you.

£ 1,175.00 excl. VAT

(£ 1,410.00 incl. VAT)

head office address

HeBlad BV
Diamantweg 22
NL - 5527 LC Hapert

Specifications Anthracite-Concrete Base Set for various tables

Product code

OVAB.PP.SET

head office address

HeBlad BV
Diamantweg 22
NL - 5527 LC Hapert

Related products



PS.DLAB.OV



PP.AB



PS.DLAB.GT



PP.R.AB



VV.AB

Our products are delivered from our factory in the Netherlands.



Park Bench with bottom plate Natural Concrete

Product code: BB.PB.OP

£ 2,250.00 excl. VAT
(£ 2,700.00 incl. VAT)

Nowadays you see our concrete park bench everywhere. When you walk through a forest, on the schoolyard, in the middle of the city, at a campsite or in a park. A concrete park bench is ideal for moments of rest on cycling and walking routes and serves as a perfect meeting place. Additionally, they form a nice combination with our concrete ping pong table, foot volleyball table or chess table.

Sustainable park bench with bamboo seat

This park bench with base plate is a DeLuxe version. This means that both the seats and backrests are made of high-quality pressed bamboo. With this bamboo seat, the park bench is also a very sustainable and durable product. Bamboo grows very quickly and is a mostly inexhaustible resource.

Park bench in different variants

The base plate and supports are made in the colour Natural Concrete. You can also opt for the Anthracite-Concrete park bench. You can combine this variant with a matching table. The dimensions of the park bench with base plate are 248 x 120 cm. The seat height is 50 cm, which is an ergonomic seat, making the park bench suitable for seniors. The supports of park benches are solid. We use high-quality concrete for this. This means you can be sure that you'll be able to use this park bench for a long time.

Concrete base plates for park bench

This park bench comes with a base plate. The base plates ensure that a park

3 April 2025 - Prices subject to change

Our products are delivered from our factory in the Netherlands.



correspondence address

HeBlad - UK

The Balance, 7th floor, Pinfold Street
S1 2GU Sheffield, South Yorkshire
T. 0114 352 0110
info@HeBlad.co.uk
www.HeBlad.co.uk

head office address

HeBlad BV

Diamantweg 22
NL - 5527 LC Hapert

bench can stand stable. A base plate is also useful when it is rainy and/or muddy. Thanks to the base plate, you will not have to worry about muddy shoes. The base plate also ensures that the maintenance of a park bench is a lot easier. This variant has a bottom plate with anti-slip pattern, which reduces the risk of slipping.

Questions about our concrete bench, table tennis tables or game tables?

Do you have any questions about the park bench with base plate or another product? Please take a look at our frequently asked questions or feel free to contact us, we will be happy to help you.

Our products are delivered from our factory in the Netherlands.

Registered under: HeBlad BV • HM Revenue and Customs • Ruby House 8 • Ruby Place • AB10 1ZP Aberdeen
VAT Number GB381060225 • EORI Number GB381060225000 • Commercial register (NL) 170 66 364
Rabobank De Kempen, Markt 7, 5531 BA Bladel (NL) • BIC RABONL2U • Branch code RABONL2UXXX • IBAN NL 20 RABO 0107530112 GBP

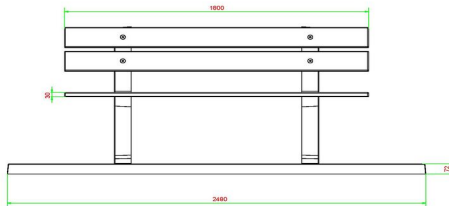
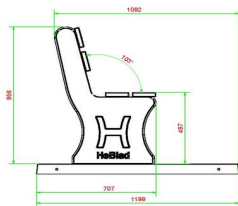
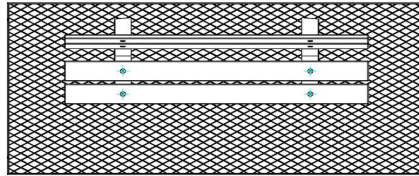

HeBlad
www.HeBlad.com
BB.PB.OP
gewicht ± 700 KG.

Specifications Park Bench with bottom plate Natural Concrete

Product code	BB.PB.OP	Material seat	Bamboo
Colour	Natural concrete	Number of seats	4
Dimensions (L x W x H)	248 x 120 x 103 cm	Dimensions base plate (L x W x H)	120 x 7 cm
Dimensions seat	180 x 30 cm	Finishing base plate	Anti-slip (window) profile
Seat height	49 cm	Weight	700 kg

Related products

103 degrees



BB.PBAB.OP

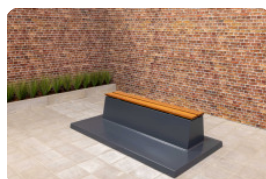

BB.DLA.OP.ZL



BB.DLAB.OP



BB.DLAB.OV

Our products are delivered from our factory in the Netherlands.



Park Bench with bottom plate Anthracite-Concrete

Product code: BB.PBAB.OP

£ 2,300.00 excl. VAT
(£ 2,760.00 incl. VAT)

With a seat and backrest made of pressed bamboo and anthracite-coloured concrete, this anthracite concrete park bench is ideal for placing in parks and lawns. The base plate associated with this concrete park bench, together with the leg and back supports, are cast from one piece of concrete. A pleasure to the eyes, practical to install and maintain and perfect for sitting.

Concrete bench from HeBlad

HeBlad products are known for their strength and long lifespan. Through years of experience in making benches, game tables and other concrete products, we know exactly which specializations are needed to make the user satisfied. This starts with the advice we give and continues through to the delivery of our products.

Delivery of the anthracite concrete park bench

Because almost all our products are available from stock, you can use your park bench within a couple of weeks after placing your order. We use a loading/unloading crane with a reach of up to five meters to deliver the park bench. If necessary, the remaining distance is covered by rolling with a pallet truck. If you are unsure whether you have the space for the crane, please contact HeBlad first so we can discuss the options for your location. You may also wish to regard the delivery conditions we've drafted.

Extension of the park bench in anthracite concrete

By placing an anthracite concrete foot volleyball table, you immediately place an

3 April 2025 - Prices subject to change

Our products are delivered from our factory in the Netherlands.



correspondence address

HeBlad - UK

The Balance, 7th floor, Pinfold Street
S1 2GU Sheffield, South Yorkshire
T. 0114 352 0110
info@HeBlad.co.uk
www.HeBlad.co.uk

head office address

HeBlad BV

Diamantweg 22
NL - 5527 LC Hapert

eye-catcher next to your concrete bench. This foot volleyball table guarantees fun and is a true jewel for your location thanks to its shape and colour. Foot volleyball is a relatively new game that is a combination of football and table tennis. Unlike table tennis, here the ball is played with the feet.

Ask your questions about the anthracite concrete park bench
We understand that HeBlad's range is incredibly large and that you could use advice when making your choice. Therefore, please be sure to contact us. We know better than anyone what visitors to your location want and what the possibilities are on your site.

Our products are delivered from our factory in the Netherlands.

Registered under: HeBlad BV • HM Revenue and Customs • Ruby House 8 • Ruby Place • AB10 1ZP Aberdeen
VAT Number GB381060225 • EORI Number GB381060225000 • Commercial register (NL) 170 66 364
Rabobank De Kempen, Markt 7, 5531 BA Bladel (NL) • BIC RABONL2U • Branch code RABONL2UXXX • IBAN NL 20 RABO 0107530112 GBP

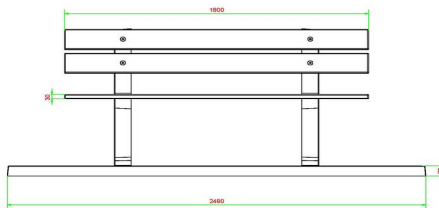
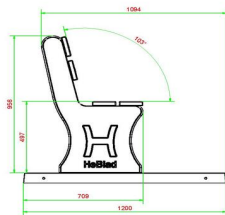
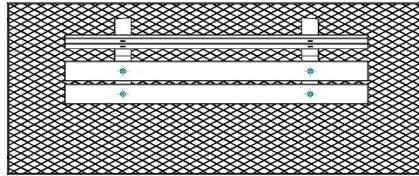
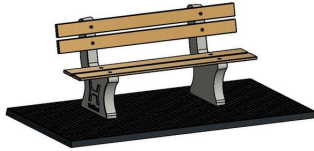

HeBlad
www.HeBlad.com
BB.PBAB.OP
gewicht ± 700 KG.

Specifications Park Bench with bottom plate Anthracite-Concrete

Product code	BB.PBAB.OP	Material seat	Bamboo
Colour	Anthracite concrete	Number of seats	4
Dimensions (L x W x H)	248 x 120 x 103 cm	Dimensions base plate (L x W x H)	1800 x 120 x 7 cm
Dimensions seat	180 x 30 cm	Finishing base plate	Anti-slip (window) profile
Seat height	49 cm	Weight	700 kg

Related products 103 degrees



BB.PB.OP



BB.DL.OP.ZL



BB.DLAB.OP



BB.DL.OV

Our products are delivered from our factory in the Netherlands.



Set of 4 Park Benches with Base Plate

Product code: BB.PB.OP.SET4

£ 5,350.00 excl. VAT
(£ 6,420.00 incl. VAT)

A pallet full of parts that ultimately guarantee years of seating pleasure. You will receive a pallet containing everything you need to install a set of four park benches.

Why use base plates? This package also includes base plates on which the benches can be placed. By working on a base plate, you can more easily level the benches and you can be sure that the surface is strong enough to support the concrete benches. Especially if you do not have an exact location for the set of park benches, it is wise to order this set including a base plate. But at HeBlad you can always order the base plates separately. With a base plate, it ultimately does not matter on which surface you place the benches.

Set of 4 park benches or preferably a single park bench

Do you lack space for the large set of 4 park benches, but are you charmed by the park bench with a bamboo seat? Then choose the DeLuxe concrete bench with backrest. Then you can offer space to four visitors in the same chic look as the set of 4. How is the DeLuxe park bench delivered? The set of 4 park benches is delivered on a pallet and you assemble it yourself. HeBlad's regular benches are delivered fully assembled and immediately placed in the right place. In the delivery terms and conditions you can read what requirements your site must meet for a safe and smooth installation.

Alternatives to the park bench

What are the alternatives to the set of 4 park benches with base plate? If you are a fan of bamboo seats, but a backrest is not absolutely necessary, then the DeLuxe concrete bench is the ideal solution. With the same strength and appearance, easy to install and combine and available in different colours.

3 April 2025 - Prices subject to change

Our products are delivered from our factory in the Netherlands.



correspondence address

HeBlad - UK

The Balance, 7th floor, Pinfold Street
S1 2GU Sheffield, South Yorkshire
T. 0114 352 0110
info@HeBlad.co.uk
www.HeBlad.co.uk

head office address

HeBlad BV

Diamantweg 22
NL - 5527 LC Hapert

We are happy to help you make a choice, always contact us if you have any questions.

Our products are delivered from our factory in the Netherlands.

Registered under: HeBlad BV • HM Revenue and Customs • Ruby House 8 • Ruby Place • AB10 1ZP Aberdeen
VAT Number GB381060225 • EORI Number GB381060225000 • Commercial register (NL) 170 66 364
Rabobank De Kempen, Markt 7, 5531 BA Bladel (NL) • BIC RABONL2U • Branch code RABONL2UXXX • IBAN NL 20 RABO 0107530112 GBP

Specifications Set of 4 Park Benches with Base Plate

head office address

Product code	BB.PB.OP.SET4	Material seat	Bamboo	HeBlad BV
Colour	Natural concrete	Number of seats	4	Diamantweg 22
Dimensions (L x W x H)	248 x 120 x 103 cm	Dimensions base plate (L x W x H)	248 x 120 x 7 cm	NL - 5527 LC Hapert
Dimensions seat	180 x 30 cm	Finishing base plate	Anti-slip (window) profile	
Seat height	49 cm	Weight	4 x 700 kg	
Seating corner	103 degrees			

Related products



BB.PBAB.OP.SET4



BB.PB.OP



BB.PBAB.OP



BB.PB.DUO



BB.PBAB.DUO

Our products are delivered from our factory in the Netherlands.



Set of 4 Park Benches with Base Plate, Anthracite-Concrete

Product code: BB.PBAB.OP.SET4

A beautiful and practical addition to your park or outdoor area. The anthracite concrete colour can give that extra touch and that matches the environment exactly. Does anthracite not seem to be the right colour at the installation location? Then choose the set of 4 concrete park benches natural concrete. Both sets are supplied with base plates in the same colour as the benches themselves.

Anthracite concrete benches

Can the benches and base plates also be ordered separately? At HeBlad you can easily order the benches and base plates separately. This way you decide how many benches you order and whether or not you use a base plate. If you have any doubts about the required space you need to have available or about installing a base plate, please contact us. We think along with you and give you honest advice.

The gaming tables from HeBlad

HeBlad has become world famous for its ping-pong tables that are located at campsites and have been played intensively for decades. We have now grown into the manufacturer of concrete game tables, benches and picnic sets. Why choose HeBlad? Because we do everything in-house, from advice and production to installation of the products, you can be assured of correct handling. But also safety, transparency and fast deliveries. You can contact us with all your questions, we will think along with you and be happy to help you.

£ 5,550.00 excl. VAT
(£ 6,660.00 incl. VAT)

3 April 2025 - Prices subject to change

Our products are delivered from our factory in the Netherlands.

Specifications Set of 4 Park Benches with Base Plate, Anthracite-Concrete

head office address

Product code	BB.PBAB.OP.SET4	Material seat	Bamboo
Colour	Anthracite concrete	Number of seats	4
Dimensions (L x W x H)	248 x 120 x 103 cm	Dimensions base plate (L x W x H)	120 x 7 cm
Dimensions seat	180 x 30 cm	Finishing base plate	Anti-slip (window) profile
Seat height	49 cm	Weight	4 x 700 kg
Seating corner	103 degrees		

HeBlad BV
Diamantweg 22
NL - 5527 LC Hapert

Related products



BB.PB.OP.SET4



BB.PBAB.OP



BB.PB.OP



BB.PBAB.DUO



BB.PB.DUO

Our products are delivered from our factory in the Netherlands.



Ping pong table low, rounded Blue

Product code: PP.AR.LOW.BL

£ 2,900.00 excl. VAT
(£ 3,480.00 incl. VAT)

Did you know that children from the age of 5 start developing their ball handling? Challenge them to a game on the table tennis table and stimulate their development. We have developed a low model of our concrete table tennis table especially for this purpose. On this low table tennis table, smaller children also have the opportunity to return a ball well. When little children play at a regular table tennis table, they often get hit in the face by the ball, or sometimes the ball even flies over their head. To accommodate for younger children, we designed a lower model table tennis table, which offers them the same opportunities the older children have.

This low concrete table tennis table is 25 centimeters lower than a competition table. For extra safety, these table tennis tables have rounded corners, which provides more safety than the regular table tennis table. Games other than table tennis can also easily be played on this lowered game table by older children and adults, such as foot volleyball. This table is ideal if you don't have enough space for an actual foot volleyball table.

Where are HeBlad's low table tennis tables located?

You will find our ping pong tables at campsites, playgrounds, parks and many other public or private areas. Wherever games can be played, you will find HeBlad's robust gaming tables. The low ping pong table with rounded corners is specifically designed for placement on school grounds for children in the lower grades of primary school. The table can certainly also be used for other purposes.

Combine the table tennis tables low with other game tables

The low table tennis table, like the other ping pong tables, can be ordered in the colours green, blue, anthracite and natural. This low table can also be perfectly

3 April 2025 - Prices subject to change

Our products are delivered from our factory in the Netherlands.



correspondence address

HeBlad - UK

The Balance, 7th floor, Pinfold Street
S1 2GU Sheffield, South Yorkshire
T. 0114 352 0110
info@HeBlad.co.uk
www.HeBlad.co.uk

head office address

HeBlad BV

Diamantweg 22
NL - 5527 LC Hapert

combined with all other HeBlad gaming tables, but also with benches and picnic sets. Because almost all our products are cast from one piece of concrete, they have a long lifespan and can be combined very nicely with each other.

Bottom plate for the ping pong tables

When is a base plate required for a ping pong table? This depends on the stability of the surface and whether maintenance can easily be carried out on the ground under the table. An optional base plate can be ordered for each ping pong table. This is not included with the table and certain conditions apply to installing a base plate.

We do recommend that you contact us when you are considering purchasing a base plate. This way we can be well prepared when it comes to the installation of both base plate and the table, and inform you of any conditions that come with the installation of the base plate.

Our products are delivered from our factory in the Netherlands.

Registered under: HeBlad BV • HM Revenue and Customs • Ruby House 8 • Ruby Place • AB10 1ZP Aberdeen
VAT Number GB381060225 • EORI Number GB381060225000 • Commercial register (NL) 170 66 364
Rabobank De Kempen, Markt 7, 5531 BA Bladel (NL) • BIC RABONL2U • Branch code RABONL2UXXX • IBAN NL 20 RABO 0107530112 GBP

Specifications Ping pong table low, rounded Blue

head office address

Product code	PP.AR.LOW.BL	Height tabletop	50 cm	HeBlad BV
Colour	Blue - RAL 5005	Height of the net	14,75 cm NL - 5527 LC Hapert	Diamantweg 22
Dimension playing surface (L x W)	274 x 152 cm	Weight	1380 kg	
Dimensions bottom of playing surface	279 x 157 cm	Distance legs	183 cm (center to center)	
Tabletop thickness	8,4 cm			

Related products



PP.AR.LOW.A



B.S1.pastel



GT.LD.AB4



OP.PP

Our products are delivered from our factory in the Netherlands.



Ping pong table low, rounded Green

Product code: PP.AR.LOW.GR

£ 2,900.00 excl. VAT
(£ 3,480.00 incl. VAT)

We have adapted our well-known concrete ping pong table, especially for children from 5 to about 8 years old. From the age of 5, children start to develop their ball control. Of course you want to encourage that! A regular table tennis table is just too high to return a ball properly. Children often even get the ball in the face, and that is frightening. The low concrete ping pong table is the solution. This low model has rounded corners for extra safety. A nice bonus of this ping pong table: for larger and older children, this ping pong table is perfect for a game of foot volleyball or 'around the table'.

Ping pong table or foot volleyball

By lowering the table it can be used for multiple games. When will you choose this or another HeBlad gaming table? Every HeBlad game table, picnic set or bench is made from a single piece of concrete and is guaranteed to be robust, sturdy and have a long lifespan. If you play a lot of foot volleyball, we have a special table for that. The game can thus be played like intended. But the extremely strong low ping pong table can also be used for this.

Ping pong table low in various designs

All ping pong tables and foot volleyball tables are available in the colours green, blue, natural and anthracite. This also applies to the low ping pong table with rounded corners. A suitable colour for every location.

Low bottom plate for ping pong table

Is a low base plate for the ping pong table recommended? To guarantee the stability of the ping pong table and keep the area around the table tidy, you can choose to order an additional base plate. This base plate is optional and is not

3 April 2025 - Prices subject to change

Our products are delivered from our factory in the Netherlands.



correspondence address

HeBlad - UK

The Balance, 7th floor, Pinfold Street
S1 2GU Sheffield, South Yorkshire
T. 0114 352 0110
info@HeBlad.co.uk
www.HeBlad.co.uk

head office address

HeBlad BV

Diamantweg 22
NL - 5527 LC Hapert

included as standard. Are you unsure about the surface on which you want to place the game table or do you have questions about the maintenance of the table or surface? Please contact us. We can advise you about the base plate and know everything about the delivery conditions of the low ping pong table and the base plate.

Our products are delivered from our factory in the Netherlands.

Registered under: HeBlad BV • HM Revenue and Customs • Ruby House 8 • Ruby Place • AB10 1ZP Aberdeen
VAT Number GB381060225 • EORI Number GB381060225000 • Commercial register (NL) 170 66 364
Rabobank De Kempen, Markt 7, 5531 BA Bladel (NL) • BIC RABONL2U • Branch code RABONL2UXXX • IBAN NL 20 RABO 0107530112 GBP

Specifications Ping pong table low, rounded Green

head office address

Product code	PP.AR.LOW.GR	Height tabletop	50 cm	HeBlad BV
Colour	Green - RAL 6009	Height of the net	14,75 cm NL - 5527 LC Hapert	Diamantweg 22
Dimension playing surface (L x W)	274 x 152 cm	Weight	1380 kg	
Dimensions bottom of playing surface	279 x 157 cm	Distance legs	183 cm (center to center)	
Tabletop thickness	8,4 cm			

Related products



PP.AR.LOW.A



PP.AR.LOW.BL



B.S1.pastel



GT.LD.4



PP.AR.GR

Our products are delivered from our factory in the Netherlands.



Ping pong table low, rounded Anthracite

Product code: PP.AR.LOW.A

£ 2,900.00 excl. VAT
(£ 3,480.00 incl. VAT)

HeBlad continues to develop and improve products and is happy to listen to market demand. Quality, functionality and sustainability come first. For example, the Picnic Set that is suitable for wheelchairs and the backgammon tables have been added to our range in various versions. Our latest addition is the low concrete table tennis table. Specially developed for the lower grades of primary school.

Low ping pong table for better development of ball handling in children
Children develop their sense of ball from the age of 5. Of course, they also like to play outside with other children. Ping-pong and 'around the table' are favourite games at schools, campsites and public spaces. The standard table tennis tables are too high for younger children. They often get the ball in the face and cannot return the ball properly with a bat. That is why we designed a table tennis table that is 25 centimeters lower than a regular table. This way they can see the ball coming and have the opportunity to play the ball back. With rounded corners, the table is a safe object at primary school.

Concrete benches at the table tennis tables

Where younger children play, adults are close by. How do you combine the table tennis tables? For example, place a beautiful concrete bench from HeBlad near the low ping-pong table, so adults have a view of the children playing and can sit comfortably. Both HeBlad's gaming tables and benches are made of sturdy, durable concrete. The products last a long time and can easily be combined with each other. This way you maintain a beautiful unity on your site and offer the users pleasure and comfort.

3 April 2025 - Prices subject to change

Our products are delivered from our factory in the Netherlands.



correspondence address

HeBlad - UK

The Balance, 7th floor, Pinfold Street
S1 2GU Sheffield, South Yorkshire
T. 0114 352 0110
info@HeBlad.co.uk
www.HeBlad.co.uk

head office address

HeBlad BV

Diamantweg 22
NL - 5527 LC Hapert

Which colour table tennis table is the best choice?

Our new model ping pong tables can be ordered in green, blue and anthracite lacquered. Other table tennis tables can also be ordered in the colours natural concrete and anthracite concrete. Because of the wide range, you can match the colour to your location and its surroundings. Are you going for striking, or for peace and unity? Everything is possible.

Bottom plate

The optional base plate can be ordered separately. The table is supplied without a base plate and delivery conditions apply to both the base plate and the game table. Always contact us for this.

When was the table tennis table born?

Table tennis has a long history and is derived from the regular game of tennis. At the end of the 19th century, people already hit a ball on a table, but scoring points was not yet part of the game. The fact that this game has become a well-known game and even an Olympic sport is due to the accessibility of the game and the pleasant way of moving when playing the game.

Our products are delivered from our factory in the Netherlands.

Registered under: HeBlad BV • HM Revenue and Customs • Ruby House 8 • Ruby Place • AB10 1ZP Aberdeen
VAT Number GB381060225 • EORI Number GB381060225000 • Commercial register (NL) 170 66 364

Rabobank De Kempen, Markt 7, 5531 BA Bladel (NL) • BIC RABONL2U • Branch code RABONL2UXXX • IBAN NL 20 RABO 0107530112 GBP

Specifications Ping pong table low, rounded Anthracite

head office address

Product code	PP.AR.LOW.A	Height tabletop	50 cm	HeBlad BV
Colour	Anthracite - RAL 7016	Height of the net	14,75 cm	Diamantweg 22
Dimension playing surface (L x W)	274 x 152 cm	Weight	1380 kg	NL - 5527 LC Hapert
Dimensions bottom of playing surface	279 x 157 cm	Distance legs	183 cm (center to center)	
Tabletop thickness	8,4 cm			

Related products



PP.AR.LOW.BL



PP.AR.LOW.GR



PP.AR.BL



PP.AR.GR



PP.AR.NT

Our products are delivered from our factory in the Netherlands.



Picnic table DeLuxe

Product code: PS.DL

£ 2,700.00 excl. VAT
(£ 3,240.00 incl. VAT)

What is meant by a picnic set?

A table with often two benches attached to it, one bench on either side, is called a picnic set. HeBlad is a leader in the range of picnic sets, in various colours, designs and sizes. The base of these designs is always concrete, resistant to all weather influences and vandalism.

Concrete Picnic Set DeLuxe

This picnic set is made from one piece of sturdy, natural concrete. For extra seating comfort, the concrete picnic set is equipped with 4 cm thick bamboo planks as a seating area. Just like the concrete, the bamboo is also weather-resistant. This means that the DeLuxe picnic set can be left outside for a lifetime. Because of the way the bamboo seats are mounted, they are not easy to remove from the picnic set. Not vandalism friendly, a feast for the eyes and a wonderful place to sit.

Where are concrete picnic sets located?

Because HeBlad products are specifically designed and made for outdoor use, this picnic set can often be found at locations such as schoolyards, parks, campsites, rest areas in nature and sports fields. Because of their beautiful appearance, the concrete picnic sets are also a perfect addition to your own garden or business park. Chic and practical come together in the DeLuxe picnic set.

The base plate for the DeLuxe picnic set

The weight of the DeLuxe picnic set is no less than 720 kg. Because of this, we've

3 April 2025 - Prices subject to change

Our products are delivered from our factory in the Netherlands.



correspondence address

HeBlad - UK

The Balance, 7th floor, Pinfold Street
S1 2GU Sheffield, South Yorkshire
T. 0114 352 0110
info@HeBlad.co.uk
www.HeBlad.co.uk

head office address

HeBlad BV

Diamantweg 22
NL - 5527 LC Hapert

drafted the necessary requirements for installing the set, included in the terms of delivery. The laying surface is also important. When the DeLuxe concrete picnic set is placed on a softer surface, we recommend using a base plate on which the picnic set is placed. This base plate is optional. If you have any doubts about the use of a base plate, please contact us. We will work with you to find the best solution.

Expansion of the DeLuxe picnic set

Thanks to the chic but natural appearance of the DeLuxe picnic set, the set can be combined very well with the concrete benches from HeBlad. Please feel free to contact us for more information about our products, delivery conditions or advice about locations and placements.

Our products are delivered from our factory in the Netherlands.

Registered under: HeBlad BV • HM Revenue and Customs • Ruby House 8 • Ruby Place • AB10 1ZP Aberdeen
VAT Number GB381060225 • EORI Number GB381060225000 • Commercial register (NL) 170 66 364
Rabobank De Kempen, Markt 7, 5531 BA Bladel (NL) • BIC RABONL2U • Branch code RABONL2UXXX • IBAN NL 20 RABO 0107530112 GBP

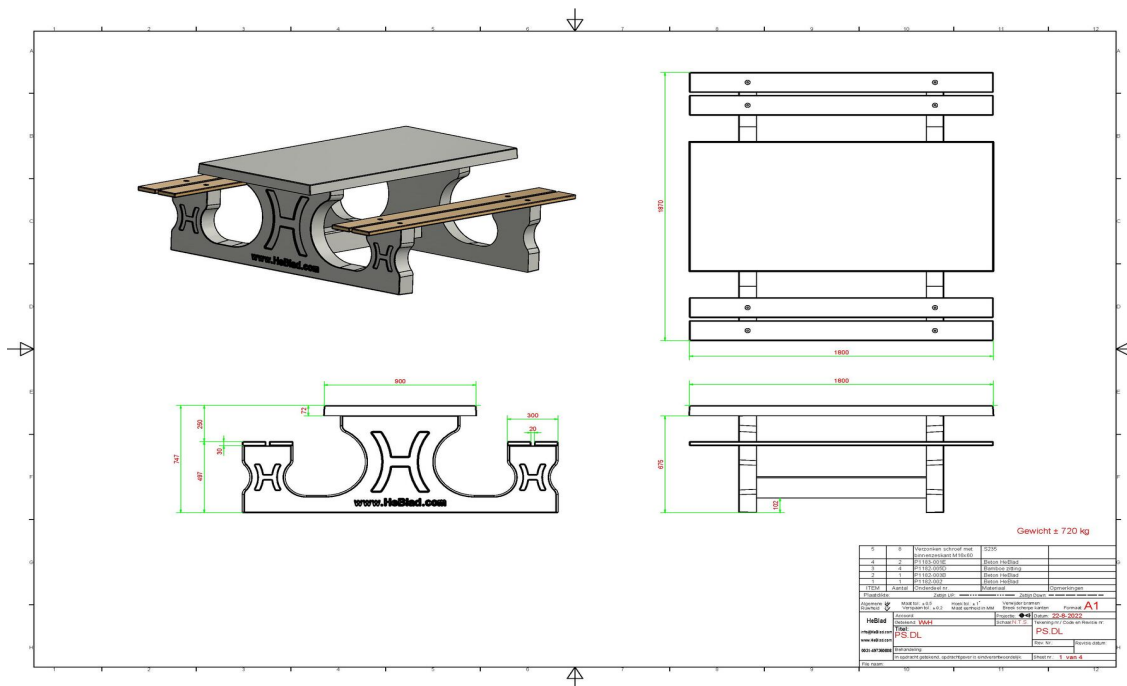

Specifications Picnic table DeLuxe

Product code	PS.DL	Seat height	50 cm
Colour	Natural concrete	Material seat	Bamboo
Dimensions (L x W x H)	180 x 187 x 75 cm	Distance legs	111 cm (center to center)
Dimensions tabletop (L x W)	180 x 90 cm	Weight	720 kg
Tabletop thickness	7 cm	Number of seats	8
Height tabletop	75 cm		

Related products



PS.DL.AB



PS.DL.A



PS.ST



OP.PS



PS.DL.OV

Our products are delivered from our factory in the Netherlands.



Concrete Picnic table DeLuxe Anthracite

Product code: PS.DL.A

£ 2,800.00 excl. VAT
(£ 3,360.00 incl. VAT)

The sleek and comfortable picnic set DeLuxe Anthracite
Sit comfortably with several people at a beautiful picnic set without worrying about theft or destruction of the set. The picnic set is specifically designed and made to provide years of outdoor service and can be placed in supervised and unsupervised areas, parks or gardens. But how much space is needed for a picnic set? Take into account the dimensions of 180 x 187 x 75 cm for the entire set and reserve extra space to move around the picnic set. To be sure, please contact us if you are unsure about the amount of space you have.

What is a good picnic set?

To determine the right picnic set, it is important to know what the seat height and table height are and how they relate to each other. With HeBlad picnic sets you can expect perfect proportions and a comfortable sitting position. Because the DeLuxe anthracite picnic set is cast from one piece of concrete with chic bamboo seats, the set is ideal for the outdoors. Impervious to weather influences and vandalism and, due to the tight coating, the anthracite colour remains beautiful and is very easy to clean.

Concrete picnic sets from HeBlad

The choice of concrete picnic sets at HeBlad is large. If the bamboo seats are not to your taste, you can opt for fully concrete picnic sets. We also have the standard anthracite concrete oval picnic set for you, if your taste or the environment leans more towards round shapes. The colours in which the various picnic sets are offered are natural concrete, anthracite concrete or anthracite lacquered. Take a

3 April 2025 - Prices subject to change

Our products are delivered from our factory in the Netherlands.



correspondence address

HeBlad - UK

The Balance, 7th floor, Pinfold Street
S1 2GU Sheffield, South Yorkshire
T. 0114 352 0110
info@HeBlad.co.uk
www.HeBlad.co.uk

head office address

HeBlad BV

Diamantweg 22
NL - 5527 LC Hapert

look at our selection and contact us if you need help choosing the right set.

Contact HeBlad

HeBlad's range is enormous and we understand that it can sometimes make it hard to choose. What is the right picnic set for your location? What are the delivery conditions? Which gaming tables does HeBlad have? Please contact us with any questions or ideas, we will be happy to help you.

Our products are delivered from our factory in the Netherlands.

Registered under: HeBlad BV • HM Revenue and Customs • Ruby House 8 • Ruby Place • AB10 1ZP Aberdeen
VAT Number GB381060225 • EORI Number GB381060225000 • Commercial register (NL) 170 66 364
Rabobank De Kempen, Markt 7, 5531 BA Bladel (NL) • BIC RABONL2U • Branch code RABONL2UXXX • IBAN NL 20 RABO 0107530112 GBP

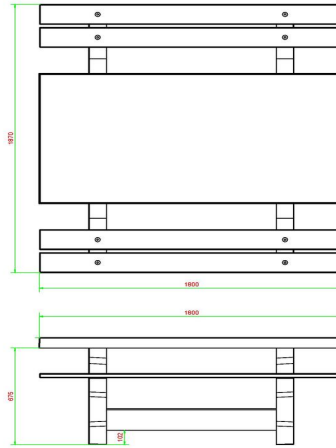
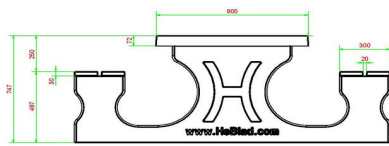

HeBlad
www.HeBlad.com
PS.DL.A
± 720 KG

Specifications Concrete Picnic table DeLuxe Anthracite

Product code	PS.DL.A	Seat height	49.7 cm
Colour	Anthracite lacquered, RAL 7016	Material seat	Bamboo
Dimensions (L x W x H)	180 x 187 x 75 cm	Distance legs	111 cm (center to center)
Dimensions tabletop (L x W)	180 x 90 cm	Weight	720 kg
Tabletop thickness	7.2 cm	Number of seats	8

Related products



PS.DL



PS.DL.AB



PS.ST.A



OP.PS.AB



PS.DL.A.OV

Our products are delivered from our factory in the Netherlands.



Picnic table DeLuxe Anthracite-Concrete

Product code: PS.DL.AB

£ 2,850.00 excl. VAT
(£ 3,420.00 incl. VAT)

The chic, robust picnic set DeLuxe Anthracite Concrete

The perfect and practical decoration of your site, garden or park. The anthracite colour gives the robust picnic set a chic look and makes it fit in anywhere. Thanks to the strength of the material and the method of production, the concrete picnic set is easy to maintain, weather-resistant and vandalism-resistant.

The bamboo seats of the benches provide extra comfort for the four to six seats, without affecting the lifespan of the picnic set.

Specifications of the picnic set DeLuxe Anthracite Concrete

How big is a picnic set? The DeLuxe picnic sets from HeBlad have the total dimensions of 180 x 187 x 75 cm, with the tabletop measuring 180 x 90 cm. The height of the table is 75 cm and the seat height of the benches is 50 cm. Proven to be the ideal height to sit comfortably. The total weight of the DeLuxe anthracite concrete picnic set is 720 kg and the set is made from one piece of anthracite-coloured concrete. If the set is unexpectedly damaged, the anthracite colour will be retained, since the material is the same colour as the exterior. Did you know that you always receive an attractive discount when ordering multiple products from HeBlad? Definitely worth contacting us or requesting a quote immediately.

Concrete picnic sets and benches from HeBlad

Because HeBlad products are all made from the same concrete, it is possible to combine different items with each other. Depending on the available space, taste and needs, the concrete benches can be a perfect addition or variation to the

3 April 2025 - Prices subject to change

Our products are delivered from our factory in the Netherlands.



correspondence address

HeBlad - UK

The Balance, 7th floor, Pinfold Street
S1 2GU Sheffield, South Yorkshire
T. 0114 352 0110
info@HeBlad.co.uk
www.HeBlad.co.uk

head office address

HeBlad BV

Diamantweg 22
NL - 5527 LC Hapert

picnic set.

Picnic set and game tables from HeBlad

All HeBlad gaming tables have the same concrete principle. Guaranteed years of outdoor fun. Place a picnic set next to a game table and you give the visitor the ideal combination of peace and action.

Our products are delivered from our factory in the Netherlands.

Registered under: HeBlad BV • HM Revenue and Customs • Ruby House 8 • Ruby Place • AB10 1ZP Aberdeen
VAT Number GB381060225 • EORI Number GB381060225000 • Commercial register (NL) 170 66 364
Rabobank De Kempen, Markt 7, 5531 BA Bladel (NL) • BIC RABONL2U • Branch code RABONL2UXXX • IBAN NL 20 RABO 0107530112 GBP

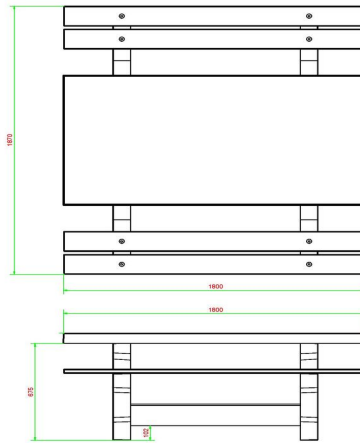
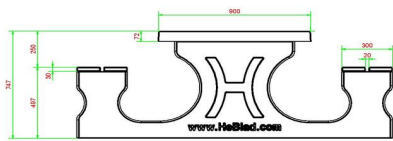

HeBlad
www.HeBlad.com
PS.DL.AB
± 720 KG.

Specifications Picnic table DeLuxe Anthracite-Concrete

Product code	PS.DL.AB	Seat height	50 cm
Colour	Anthracite concrete	Material seat	Bamboo
Dimensions (L x W x H)	180 x 187 x 75 cm	Distance legs	111 cm (center to center)
Dimensions tabletop (L x W)	180 x 90 cm	Weight	720 kg
Tabletop thickness	7 cm	Number of seats	8

Related products 75 cm



PS.DL



PS.DL.A



PS.ST.AB



OP.PS.AB



PS.DLAB.OV

Our products are delivered from our factory in the Netherlands.



Set of chessmen

Product code: GT.CH.Pieces

£ 19.00 excl. VAT
(£ 22.80 incl. VAT)

A chess game without chess pieces is not a game. That is why all HeBlad chess tables, chess benches and multi-game tables are supplied with the corresponding chess pieces as standard. Because the chess pieces can of course be damaged or lost, you can easily order a separate set of chess pieces online.

Specifications set of chess pieces

The set of chess pieces consists of 32 items, 16 pieces in the white, light colour and 16 pieces in the darker, brown colour. The chess pieces are made of wood, the height of the King is almost 8 cm and all pieces have felt on the underside to prevent scratches on the chessboard. Once we have received your order, we will send you the set within two working days.

Chess pieces for chess table and multi game table

As with every chess game, chess pieces are needed, so we supply pawns with a die for every ludo table. We supply checkers with every checkers game and with every multi-game table all the accessories the table needs for optimal gaming fun. All these attributes can be ordered separately via the website or by contacting us. To play safely at the football tables, we have eye protectors and rubber bumpers available. The table football balls can also be ordered separately. This also applies to the bar, the football figures and the handle, so that you can always play table football.

Contact HeBlad

For your convenience and speed, you can easily order all your products online via the website. Just like HeBlad's products, our service is also robust and reliable. With us you can be assured of the right advice, clear agreements and production

3 April 2025 - Prices subject to change

Our products are delivered from our factory in the Netherlands.



correspondence address

HeBlad - UK

The Balance, 7th floor, Pinfold Street
S1 2GU Sheffield, South Yorkshire
T. 0114 352 0110
info@HeBlad.co.uk
www.HeBlad.co.uk

head office address

HeBlad BV

Diamantweg 22
NL - 5527 LC Hapert

and delivery with care. Thanks to years of experience, we know exactly which game table, concrete bench, picnic set or ping-pong table best suits your site. Please feel free to contact us with any questions about HeBlad products, delivery conditions, specifications or if you have any ideas. We have a team of skilled employees ready to assist you.

Our products are delivered from our factory in the Netherlands.

Registered under: HeBlad BV • HM Revenue and Customs • Ruby House 8 • Ruby Place • AB10 1ZP Aberdeen
VAT Number GB381060225 • EORI Number GB381060225000 • Commercial register (NL) 170 66 364
Rabobank De Kempen, Markt 7, 5531 BA Bladel (NL) • BIC RABONL2U • Branch code RABONL2UXXX • IBAN NL 20 RABO 0107530112 GBP

Specifications Set of chessmen

Product code	GT.CH.Pieces
Material	Wood
King height	7,7 cm

head office address

HeBlad BV
Diamantweg 22
NL - 5527 LC Hapert

Related products



GT.CH.G4



HB.FB.A



BB.CH



GT.CH.AB2

Our products are delivered from our factory in the Netherlands.



Set of checkers/drafts

Product code: GT.CK.Pieces

£ 12.00 excl. VAT
(£ 14.40 incl. VAT)

When you order one of our beautiful checkers tables, it will be delivered with 1 set of checkers. Because without checkers, there is no checkers game! Each set of checkers contains 20 light and 20 dark stones. If you ever want to order new checkers, you can also order a separate set of checkers from HeBlad. Simply online or by contacting us.

Receive checkers at a discount

HeBlad offers a very attractive discount when you order multiple products in addition to your checkers. This way you can save up a lot of money on your set of checkers. Once your order has been placed, delivery will take place quickly, because we can often deliver from stock.

Checkers for the HeBlad game tables

The choice is huge in checkers tables or benches at HeBlad. Are you looking for a robust appearance? Then the checkers bank is a good choice. The bench is made in one piece and is available in the natural concrete checkerboard version, with a natural light appearance. The anthracite concrete version has a dark colour based on coloured concrete. Both the inside and outside of the bench have the same anthracite concrete colour.

In addition to checkers benches, we also make checkers tables. The seats are separate from the game table. The checkers tables are available as an anthracite-concrete checkers table for 4 people or an anthracite-concrete checkers table for 2 people. If you prefer a lighter colour for the game table, then the natural concrete checkers table for 4 people or the natural concrete checkers table for 2 people may suit your tastes better.

3 April 2025 - Prices subject to change

Our products are delivered from our factory in the Netherlands.



correspondence address

HeBlad - UK

The Balance, 7th floor, Pinfold Street
S1 2GU Sheffield, South Yorkshire
T. 0114 352 0110
info@HeBlad.co.uk
www.HeBlad.co.uk

head office address

HeBlad BV

Diamantweg 22
NL - 5527 LC Hapert

Checkers and chess pieces

Would you like to place a chess table or bench in addition to your checkers table or bench? That would be a very nice addition! Of course, when you order a chess bench or chess table, you will receive a set of chess pieces as a gift. Wondering what the best gaming table is for your location? Please contact us, we will be happy to inform you about the possibilities.

For a separate order, the following applies: as soon as we receive the order, the package will be shipped to you within 2 working days.

Our products are delivered from our factory in the Netherlands.

Registered under: HeBlad BV • HM Revenue and Customs • Ruby House 8 • Ruby Place • AB10 1ZP Aberdeen
VAT Number GB381060225 • EORI Number GB381060225000 • Commercial register (NL) 170 66 364
Rabobank De Kempen, Markt 7, 5531 BA Bladel (NL) • BIC RABONL2U • Branch code RABONL2UXXX • IBAN NL 20 RABO 0107530112 GBP

Specifications Set of checkers/drafts

Product code	GT.CK.Pieces
Material	Wood

head office address

HeBlad BV
Diamantweg 22
NL - 5527 LC Hapert

Related products



GT.CK.AB2



GT.CK.AB4



HB.FB.A



BB.CK

Our products are delivered from our factory in the Netherlands.



Set of pawns with a dice

Product code: GT.LD.Pieces

£ 10.00 excl. VAT
(£ 12.00 incl. VAT)

When you order a gaming table from HeBlad, you will always receive a set of the necessary accessories. Every ludo table or multi-game table comes with a set of pawns and die. This set is made of wood and the pawns have a height of four centimeters. In order to play the game properly, the set of pawns consists of four times four pawns of different colours.

The whole is housed in a transparent plexiglass cube. After arranging the pieces, you can leave the die in it and shake this container and then place it on the table. Loose set of pawns with die

At HeBlad we understand that pawns and dice can be lost, damaged or simply insufficient for the number of participants. That is why we also offer the set of pawns with die separately.

Accessories from HeBlad

We have included the most vulnerable parts for each gaming table in our range of accessories. Play unlimited table tennis on ping pong tables with plastic bats in sets of four or ten. Or treat yourself to the starter pack of bats and balls. Of course, the ping pong balls are also available separately in different quantities. HeBlad's chess tables, chess benches, ludo tables, checkers tables and checkers benches are supplied with chess pieces or checkers. You can order a separate set if your set is lost or damaged or as a spare set. Do you have a damaged or lost part or accessory to your HeBlad gaming table? Please contact us so that we can help you replace or repair the part.

Game tables and pawns with dice

All HeBlad gaming tables include the necessary accessories. Even with a multi-game table that contains no fewer than three games. You will receive all

3 April 2025 - Prices subject to change

Our products are delivered from our factory in the Netherlands.



correspondence address

HeBlad - UK

The Balance, 7th floor, Pinfold Street
S1 2GU Sheffield, South Yorkshire
T. 0114 352 0110
info@HeBlad.co.uk
www.HeBlad.co.uk

head office address

HeBlad BV

Diamantweg 22
NL - 5527 LC Hapert

pawns, dice, chess pieces or checkers with this versatile game table and you can order all accessories separately or in addition to each other. You can easily order all accessories online, but you are also cordially invited to contact us to place your order or ask your question.

Our products are delivered from our factory in the Netherlands.

Registered under: HeBlad BV • HM Revenue and Customs • Ruby House 8 • Ruby Place • AB10 1ZP Aberdeen
VAT Number GB381060225 • EORI Number GB381060225000 • Commercial register (NL) 170 66 364
Rabobank De Kempen, Markt 7, 5531 BA Bladel (NL) • BIC RABONL2U • Branch code RABONL2UXXX • IBAN NL 20 RABO 0107530112 GBP

Specifications Set of pawns with a dice

Product code	GT.LD.Pieces
Material	Wood
Height pawns	3 cm

head office address

HeBlad BV
Diamantweg 22
NL - 5527 LC Hapert

Related products

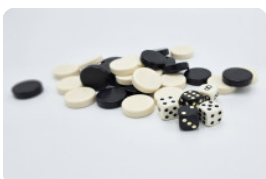

GT.BG.pieces



GT.CK.Pieces



GT.LD.AB4



GT.LD.4



PS.DL.GT.132

Our products are delivered from our factory in the Netherlands.



Backgammon stones and dice

Product code: GT.BG.pieces

£ 19.00 excl. VAT
(£ 22.80 incl. VAT)

A board game cannot be played without associated accessories. For the backgammon game, checkers in black and white and a set of five dice are indispensable. That is why we supply these stones and dice free of charge with the delivery of a multi-game table with backgammon board or another game table in which the backgammon game is integrated. If the accessories are lost or damaged, they can easily be ordered via this website.

Backgammon accessories and game rules

How is the backgammon game played? One player plays with the white stones and the opponent plays with black. The points on the board and the throwing of the dice determine the order in which the stones are moved across the board in order to be the first to get all the stones to the other side. Players can hit each other's stones.

Backgammon and other gaming tables

The game of backgammon dates back to Mesopotamia and is approximately 5,000 years old. Of course, the game has evolved over time to the version we know today.

The great thing about a HeBlad game table is that they can easily be combined with one another. For example, consider a combination of the backgammon table with a foot volleyball table. In this way you create a beautiful balance between mental sport and physical sport. A game as old as time, combined with a relatively new game. Or consider a combination with one of the banks. Thanks to the unity in design and colour, all HeBlad products can easily be combined with each other.

3 April 2025 - Prices subject to change

Our products are delivered from our factory in the Netherlands.



correspondence address

HeBlad - UK

The Balance, 7th floor, Pinfold Street
S1 2GU Sheffield, South Yorkshire
T. 0114 352 0110
info@HeBlad.co.uk
www.HeBlad.co.uk

head office address

HeBlad BV

Diamantweg 22
NL - 5527 LC Hapert

Contact HeBlad

Would you like to decorate your site with a game table or concrete bench from HeBlad? Please contact us. We are happy to think along with you and know exactly what the possibilities are for your space.

Our products are delivered from our factory in the Netherlands.

Registered under: HeBlad BV • HM Revenue and Customs • Ruby House 8 • Ruby Place • AB10 1ZP Aberdeen
VAT Number GB381060225 • EORI Number GB381060225000 • Commercial register (NL) 170 66 364
Rabobank De Kempen, Markt 7, 5531 BA Bladel (NL) • BIC RABONL2U • Branch code RABONL2UXXX • IBAN NL 20 RABO 0107530112 GBP

Specifications Backgammon stones and dice

Product code	GT.BG.pieces
Material	Kunststof

head office address

HeBlad BV
Diamantweg 22
NL - 5527 LC Hapert

Related products



GT.BG.2



GT.BG.4



BB.BG



BB.BG.AB



PS.DL.GT.134

Our products are delivered from our factory in the Netherlands.



Backgammon Table Natural Concrete (2P)

Product code: GT.BG.2

£ 3,300.00 excl. VAT
(£ 3,960.00 incl. VAT)

A light-coloured, aesthetically pleasing, slim and functional game table for the outdoors. With the right seat and table top height, it is a great place to sit. The backgammon board game is integrated into the table top itself. The table and seats are made of concrete and the game board is made of natural stone, specifically designed and made for outdoor use.

What is backgammon?

In the board game backgammon, players have to move stones across the board from one side to the other. The points are determined using a die. The opponent walks across the board in the opposite direction. Along the way the other person's stones can be struck. The goal is to be the first to bring 15 stones to the other side of the board.

Concrete backgammon table from HeBlad

Which backgammon table is best to buy? HeBlad backgammon tables are designed and produced to be used outdoors for many, many years. The strong and durable concrete makes the tables impervious to vandalism, damage and weather influences. Depending on the available space, the location and the number of seats desired, you can choose from different options. The backgammon table for 2 persons is available in natural concrete and anthracite concrete. The backgammon table is also available in the same colours in a 4-person version. The backgammon game is also included in HeBlad's multi-game tables.

3 April 2025 - Prices subject to change

Our products are delivered from our factory in the Netherlands.



correspondence address

HeBlad - UK

The Balance, 7th floor, Pinfold Street
S1 2GU Sheffield, South Yorkshire
T. 0114 352 0110
info@HeBlad.co.uk
www.HeBlad.co.uk

head office address

HeBlad BV

Diamantweg 22
NL - 5527 LC Hapert

Backgammon tables and other game tables from HeBlad

Because all HeBlad gaming tables are made from one piece of concrete, they will last for decades. Rain or sunshine, you can always play and sit at these tables. All products can be perfectly combined due to their similar appearance or to contrast in colour or robustness. For example, place a chess table next to a backgammon table or display a concrete bench on the side of a game table.

For questions or deliveries, please contact us, we will be happy to help you.

*When you order a backgammon table, you will receive one set of backgammon pieces for free. This includes five dice.

Our products are delivered from our factory in the Netherlands.

Registered under: HeBlad BV • HM Revenue and Customs • Ruby House 8 • Ruby Place • AB10 1ZP Aberdeen
VAT Number GB381060225 • EORI Number GB381060225000 • Commercial register (NL) 170 66 364
Rabobank De Kempen, Markt 7, 5531 BA Bladel (NL) • BIC RABONL2U • Branch code RABONL2UXXX • IBAN NL 20 RABO 0107530112 GBP

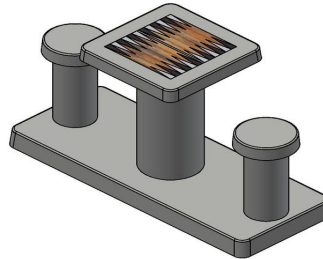
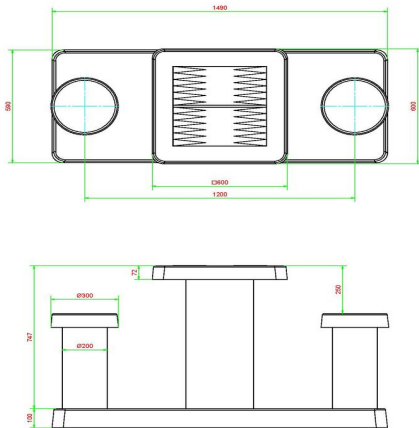

HeBlad
www.HeBlad.com
GT.BG.2
Gewicht ± 490 KG.

Specifications Backgammon Table Natural Concrete (2P)

Product code	GT.BG.2	Height tabletop	75 cm
Colour	Natural concrete	Seat height	50 cm
Dimensions (L x W x H)	149 x 59 x 85 cm	Dimensions base plate (L x W x H)	160 x 10 cm
Dimensions tabletop (L x W)	60 x 60 cm	Weight	425 kg
Tabletop thickness	7 cm		

Related products



GT.BG.AB2



GT.BG.4

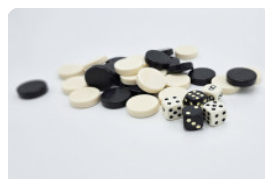

GT.BG.pieces

Our products are delivered from our factory in the Netherlands.



Backgammon Table Anthracite-Concrete (2P)

Product code: GT.BG.AB2

£ 3,400.00 excl. VAT
(£ 4,080.00 incl. VAT)

Durable, subtle and incredibly practical. That describes the backgammon table for 2 persons in anthracite concrete colour. Made to be enjoyed for years to come. The tabletop is equipped with the board game backgammon, so the table can be used as a game table, but also as a regular table with two seats. The concrete anthracite colour retains its original colour for years, because the concrete has this colour through and through. Because it is made entirely from quality concrete, the table is not sensitive to extreme weather conditions or damage. The slim appearance of the table makes it suitable for smaller locations or to combine with other HeBlad game tables, benches or picnic sets.

Specifications of the backgammon table for 2 persons

What makes the backgammon table so special? Both the table and the seats are made of anthracite concrete, which means that the concrete is anthracite through and through. Colour retention is therefore guaranteed. The weight makes the table perfect for (public) outdoor areas. The seats have a height of 50 cm and the tabletop is 75 cm. The backgammon game board is integrated into the tabletop and made of natural stone. The tabletop measurements are 60 x 60 cm x 10 cm.

How is the backgammon table placed?

Due to the weight and size of the 2-person anthracite concrete backgammon table, we transport and install the table for you. We have drafted delivery conditions for a smooth delivery. This is to prevent our truck and crane from not being able to reach the destination. If you want to move the table in the future, you can request a move from us. This way you do not have to arrange any

3 April 2025 - Prices subject to change

Our products are delivered from our factory in the Netherlands.



correspondence address

HeBlad - UK

The Balance, 7th floor, Pinfold Street
S1 2GU Sheffield, South Yorkshire
T. 0114 352 0110
info@HeBlad.co.uk
www.HeBlad.co.uk

head office address

HeBlad BV

Diamantweg 22
NL - 5527 LC Hapert

equipment yourself, and you can be assured of the correct treatment of your beautiful 2-person anthracite concrete backgammon table.

Questions about the HeBlad backgammon table?

Please contact us if you have any questions, need advice or have any questions about our products, working methods, delivery times or options. We are happy to help you and provide your site with a HeBlad product with love.

* When you order a backgammon table, you will receive one set of backgammon pieces for free. This includes five dice.

Our products are delivered from our factory in the Netherlands.

Registered under: HeBlad BV • HM Revenue and Customs • Ruby House 8 • Ruby Place • AB10 1ZP Aberdeen
VAT Number GB381060225 • EORI Number GB381060225000 • Commercial register (NL) 170 66 364
Rabobank De Kempen, Markt 7, 5531 BA Bladel (NL) • BIC RABONL2U • Branch code RABONL2UXXX • IBAN NL 20 RABO 0107530112 GBP

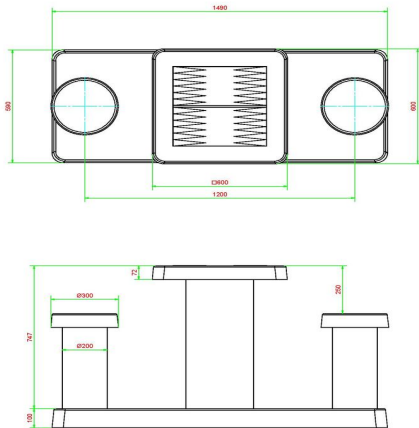

HeBlad
www.HeBlad.com
GT.BG.AB2
Gewicht ± 490 KG.

Specifications Backgammon Table Anthracite-Concrete (2P)

Product code	GT.BG.AB2	Height tabletop	75 cm
Colour	Anthracite concrete	Seat height	50 cm
Dimensions (L x W x H)	149 x 59 x 85 cm	Dimensions base plate (L x W x H)	1200 x 60 x 10 cm
Dimensions tabletop (L x W)	60 x 60 cm	Weight	425 kg
Tabletop thickness	7 cm		

Related products



GT.BG.2



GT.BG.4

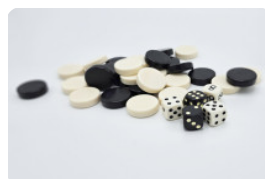

GT.BG.pieces

Our products are delivered from our factory in the Netherlands.



Backgammon Table Natural Concrete (4P)

Product code: GT.BG.4

£ 3,500.00 excl. VAT
(£ 4,200.00 incl. VAT)

The board game backgammon is one of the oldest games in history and has been around for thousands of years. It is said to have originated in Mesopotamia, modern-day Iraq and Iran. The game has evolved over time, but can be traced back far back in history: approximately 5,000 years. The ancient Greeks and Egyptians were depicted playing backgammon. And the game was also very popular during the Renaissance in France.

Concrete backgammon table for 4 people

HeBlad's game tables, benches and picnic sets are designed and produced in our own factory and are made of one piece of concrete. This concrete is intended to serve outdoor locations for many years. The backgammon table has a slim appearance due to the standalone stools, but is incredibly sturdy due to its massive weight.

Where can you place the backgammon table?

This is possible in any outdoor area. The tables can be found in parks, private gardens, campsites, parking lots and schoolyards. Because the table is also perfectly suitable for sitting in addition to playing a game, it is an asset to any site. The 4 seats offer space for up to 4 people to sit and use the game board as intended, or as a regular table.

Backgammon and other game tables from HeBlad

Because HeBlad has made it a mission to bring people together and let them

3 April 2025 - Prices subject to change

Our products are delivered from our factory in the Netherlands.



correspondence address

HeBlad - UK

The Balance, 7th floor, Pinfold Street
S1 2GU Sheffield, South Yorkshire
T. 0114 352 0110
info@HeBlad.co.uk
www.HeBlad.co.uk

head office address

HeBlad BV

Diamantweg 22
NL - 5527 LC Hapert

exercise or think together, our products can be perfectly combined with each other. Whether you choose a ping pong table, foot volleyball table or another game table, everything comes from our own factory and is made of concrete. Thanks to the unity in design and colour, you also have the option to easily combine an active gaming table with a mind sports table. This way you can provide fun for everyone. For all your questions about the 4-person natural concrete backgammon table or other HeBlad products, you can always contact us. We are happy to think along with you.

* When you order a backgammon table, you will receive one set of backgammon pieces for free. This includes five dice.

Our products are delivered from our factory in the Netherlands.

Registered under: HeBlad BV • HM Revenue and Customs • Ruby House 8 • Ruby Place • AB10 1ZP Aberdeen
VAT Number GB381060225 • EORI Number GB381060225000 • Commercial register (NL) 170 66 364
Rabobank De Kempen, Markt 7, 5531 BA Bladel (NL) • BIC RABONL2U • Branch code RABONL2UXXX • IBAN NL 20 RABO 0107530112 GBP

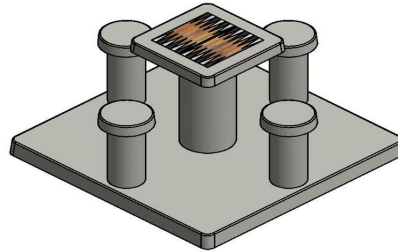
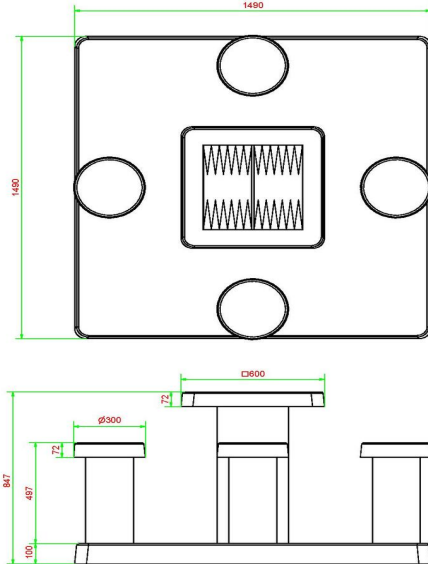

HeBlad
www.HeBlad.com
GT.BG.4

± 900 KG.

Specifications Backgammon Table Natural Concrete (4P)

Product code	GT.BG.4	Height tabletop	75 cm
Colour	Natural concrete	Seat height	50 cm
Dimensions (L x W x H)	149 x 149 x 85 cm	Dimensions base plate (L x W x H)	149 x 149 x 10 cm
Dimensions tabletop (L x W)	60 x 60 cm	Weight	900 kg
Tabletop thickness	7 cm		

Related products



GT.BG.2



GT.BG.AB4

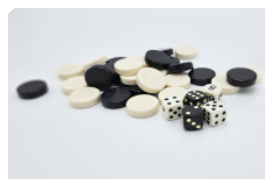

GT.BG.pieces

Our products are delivered from our factory in the Netherlands.



Backgammon Table Anthracite-Concrete (4P)

Product code: GT.BG.AB4

£ 3,600.00 excl. VAT
(£ 4,320.00 incl. VAT)

This backgammon game table is made in anthracite-concrete colour. It has four seats, each placed on one side of the tabletop. A backgammon board game has been placed in this tabletop. There is no height difference in the tabletop itself and the table can also be used as a regular table.

What is backgammon also known as?

Backgammon is an English contraction of back and game. Over the centuries, the original game has changed and evolved. The current backgammon board game is also known in the Netherlands as Tric Tac or Tritrak. In France, the game is called Tric Trac, while in Spain it is called Tables Reales. The backgammon game is internationally well known and fits very well into HeBlad's range of gaming tables.

Backgammon table, ludo table, chess table and checkers table

The 4-person anthracite concrete backgammon table is also available with the same specifications, but in the version of a ludo table, chess table or checkers table. In these versions, the tabletop is equipped with a ludo board, chessboard or checkerboard respectively. All these tables can also be combined, so that each table on your site offers a different board game. If your available space cannot accommodate four tables, you can also opt for one of HeBlad's standard or deluxe multi-game tables. These tables are available in a picnic set version, the tabletop of which contains various board games. You can then offer different types of games and give visitors the opportunity to sit comfortably, while you need less space than if you opted for separate game tables.

Backgammon table and concrete benches

Due to the slim appearance of the backgammon table, it is nice to place a robust

3 April 2025 - Prices subject to change

Our products are delivered from our factory in the Netherlands.



correspondence address

HeBlad - UK

The Balance, 7th floor, Pinfold Street
S1 2GU Sheffield, South Yorkshire
T. 0114 352 0110
info@HeBlad.co.uk
www.HeBlad.co.uk

head office address

HeBlad BV

Diamantweg 22
NL - 5527 LC Hapert

concrete bench with it. These give visitors more space to sit. In addition, the benches can serve as a fence or security for your site. They are quite useful in preventing ram raids for example. The benches are available in many different designs, in the same anthracite concrete colour or in the light natural concrete colour for extra contrast.

How are the backgammontable and other products placed?

Due to the heaviness of HeBlad's products, we will place the products for you at your location in accordance with our delivery conditions. Would you like to know whether your location is suitable for HeBlad products? Please contact us. We know what the possibilities are, and are happy to help you!

* When you order a backgammon table, you will receive one set of backgammon pieces for free. This includes five pieces of dice.

Our products are delivered from our factory in the Netherlands.

Registered under: HeBlad BV • HM Revenue and Customs • Ruby House 8 • Ruby Place • AB10 1ZP Aberdeen
VAT Number GB381060225 • EORI Number GB381060225000 • Commercial register (NL) 170 66 364
Rabobank De Kempen, Markt 7, 5531 BA Bladel (NL) • BIC RABONL2U • Branch code RABONL2UXXX • IBAN NL 20 RABO 0107530112 GBP

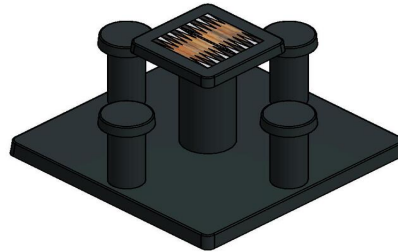
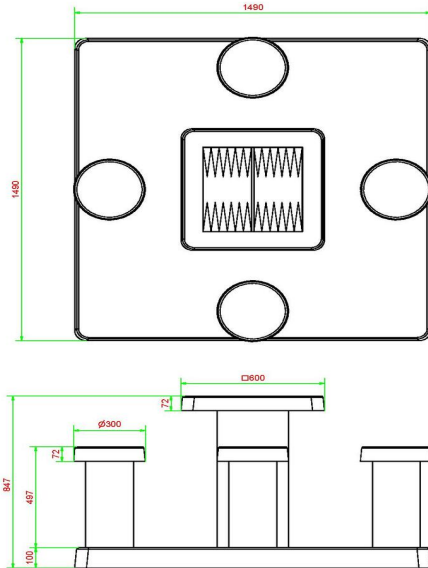

HeBlad
www.HeBlad.com
GT.BG.AB4
± 900 KG.

Specifications Backgammon Table Anthracite-Concrete (4P)

Product code	GT.BG.AB4	Height tabletop	75 cm
Colour	Anthracite concrete	Seat height	50 cm
Dimensions (L x W x H)	149 x 149 x 85 cm	Dimensions base plate (L x W x H)	149 x 149 x 10 cm
Dimensions tabletop (L x W)	60 x 60 cm	Weight	900 kg
Tabletop thickness	7 cm		

Related products



GT.BG.AB2



GT.BG.4

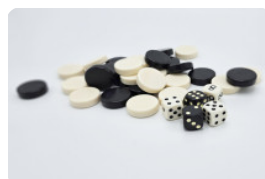

GT.BG.pieces

Our products are delivered from our factory in the Netherlands.



Bench natural concrete oval

Product code: BB.ST.OV

£ 1,750.00 excl. VAT
(£ 2,100.00 incl. VAT)

This oval concrete bench is solid, practical and beautiful! HeBlad products are known for their robustness and indestructibility, but certainly also for their practical and beautiful applications. This natural concrete bench in oval design is no exception. With its high compressive strength and beautiful design, this natural concrete oval concrete bench is a safe, practical and attractive addition to your location.

Very strong oval concrete bench in the colour natural concrete

Because this concrete bench is made of high-quality C45/55 concrete, this gem has a very high compressive strength. The concrete bench is made from one piece of natural concrete and weighs 900 kg, which makes the bench impervious to vandalism and provides your location or facility with security. For extra stability, HeBlad can even supply a matching concrete base plate.

Beautiful through simplicity: oval bench for outdoors

With its subtle oval shape, this concrete bench made of natural concrete is a real decoration for your square, park or garden. The oval shape gives a playful character to the bench and can for example be placed with several benches in a circle or like waves across the schoolyard. This beautiful bench can also be an attractive partition for your border or sandbox. Do you prefer a different version? Then go for the standard concrete bench or make a different colour choice such as the standard anthracite-concrete oval bench.

Enjoy outdoor seating on a robust concrete bench

3 April 2025 - Prices subject to change

Our products are delivered from our factory in the Netherlands.



correspondence address

HeBlad - UK

The Balance, 7th floor, Pinfold Street
S1 2GU Sheffield, South Yorkshire
T. 0114 352 0110
info@HeBlad.co.uk
www.HeBlad.co.uk

head office address

HeBlad BV

Diamantweg 22
NL - 5527 LC Hapert

The high-quality natural concrete from which the concrete bench is made offers resistance to all weather influences and is easy to maintain. The concrete bench has been specifically developed to provide seating comfort to users in the outdoors. With an ideal seat height and depth, four adults can easily sit on the standard oval concrete bench.

Combine a concrete bench with a concrete table tennis table or other game table

The possibilities for combining the standard oval concrete bench with other game tables, benches or picnic sets are endless. Consider, for example, our concrete table tennis table, foot volleyball table or game table. Inquire about all choices by contacting us, we are happy to help you!

Our products are delivered from our factory in the Netherlands.

Registered under: HeBlad BV • HM Revenue and Customs • Ruby House 8 • Ruby Place • AB10 1ZP Aberdeen
VAT Number GB381060225 • EORI Number GB381060225000 • Commercial register (NL) 170 66 364
Rabobank De Kempen, Markt 7, 5531 BA Bladel (NL) • BIC RABONL2U • Branch code RABONL2UXXX • IBAN NL 20 RABO 0107530112 GBP

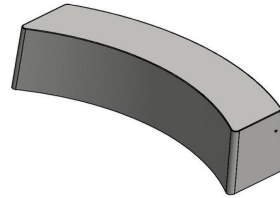
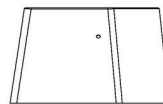
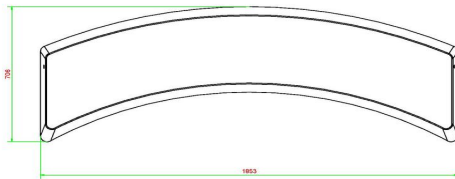

HeBlad
www.HeBlad.com
BB.ST.OV
gewicht ± 900 KG.

Specifications Bench natural concrete oval

Product code	BB.ST.OV	Material seat	Beton
Colour	Natural concrete	Number of seats	4
Dimensions (L x W x H)	185 x 70 x 50 cm	Weight	900 kg
Seat height	50 cm		

Related products



BB.STAB.OV



PS.ST.OV



BB.ST



BB.ST.A



BB.ST.AB

Our products are delivered from our factory in the Netherlands.



Bench standard oval anthracite-concrete

Product code: BB.STAB.OV

£ 1,825.00 excl. VAT
(£ 2,190.00 incl. VAT)

Use this oval concrete bench in anthracite concrete colour as seating or as security against ram raids. Thanks to its robustness, this bench won't look out of place anywhere. The concrete bench with an oval shape is a beautiful addition to the garden, park, city center or parking lot. This bench is ideal to provide seating for passers-by, but also to prevent burglary or to separate part of your location.

Oval bench made of concrete is a practical, playful addition

A sturdy seat and robust appearance make this concrete bench a solid place to seat four people. A pleasant gathering in a comfortable sitting position. Because the bench is cast in anthracite-coloured concrete, the colour can be seen in the entire bench.

Combine concrete bench with other outdoor benches and game tables

Because HeBlad products are specifically designed for outdoor use, this concrete bench for public spaces can be perfectly combined with HeBlad's game tables, other benches and picnic sets. For example, create a circular shape with several concrete oval benches in the same colour or in natural concrete or anthracite lacquered colour. You could also give your location an extra dimension by installing a foot volleyball table, table football table or concrete ping-pong table, so that the concrete bench is a resting place for viewers or resting athletes.

Delivery concrete bench

HeBlad produces all products in our own factory, which is why we almost always

3 April 2025 - Prices subject to change

Our products are delivered from our factory in the Netherlands.



correspondence address

HeBlad - UK

The Balance, 7th floor, Pinfold Street
S1 2GU Sheffield, South Yorkshire
T. 0114 352 0110
info@HeBlad.co.uk
www.HeBlad.co.uk

head office address

HeBlad BV

Diamantweg 22
NL - 5527 LC Hapert

deliver from stock. We have a delivery time of 0 to 4 working weeks in the Netherlands. This may be different in the UK, so be sure to consult the terms and conditions of delivery or contact us for a delivery date.

Due to the weight of the concrete bench, it is delivered via the loading/unloading crane on our truck. It is important that our driver can get the truck close to the place where the concrete bench will be placed.

Always contact HeBlad for the terms and conditions of delivery. We will then discuss the method of delivery, which will prevent any unpleasant surprises. We make every effort to deliver to your satisfaction and will advise you, for example, whether a concrete base plate is advisable in your case.

Our products are delivered from our factory in the Netherlands.

Registered under: HeBlad BV • HM Revenue and Customs • Ruby House 8 • Ruby Place • AB10 1ZP Aberdeen
VAT Number GB381060225 • EORI Number GB381060225000 • Commercial register (NL) 170 66 364

Rabobank De Kempen, Markt 7, 5531 BA Bladel (NL) • BIC RABONL2U • Branch code RABONL2UXXX • IBAN NL 20 RABO 0107530112 GBP

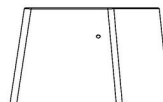
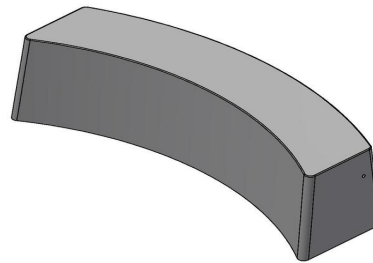
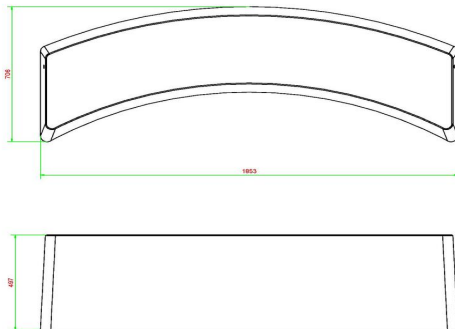

HeBlad
www.HeBlad.com
BB.STAB.OV
gewicht ± 900 KG.

Specifications Bench standard oval anthracite-concrete

Product code	BB.STAB.OV	Material seat	Beton
Colour	Anthracite concrete	Number of seats	4
Dimensions (L x W x H)	185 x 70 x 50 cm	Weight	900 kg
Seat height	50 cm		

Related products



BB.DLA.OV



PS.ST.OV



BB.ST



BB.ST.A



BB.ST.AB

Our products are delivered from our factory in the Netherlands.



Bench standard oval anthracite

Product code: BB.STA.OV

£ 1,800.00 excl. VAT
(£ 2,160.00 incl. VAT)

This oval concrete bench from HeBlad in anthracite concrete colour is a true eye-catcher in any public space. With this concrete bench you are assured of the reliability you've come to expect from HeBlad. The weight of 900 kg and the fully concrete design of the bench guarantee strength and vandalism resistance. This oval standard bench is sprayed with high-quality paint in anthracite colour. This gives you a solid bench with a playful appearance in a warm colour that requires little maintenance.

Oval concrete bench offers pleasant seating

Use this concrete bench in anthracite colour to create seats in your schoolyard, park or garden. A robust addition with a subtle appearance. Four people can sit comfortably on this bench and the appearance is chic thanks to the anthracite colour and oval shape. The bench owes its shape and appearance to the use of concrete and high-quality paint. Weather conditions do not affect this concrete bench.

Oval concrete bench as a partition or security

Due to its solidity, this oval concrete bench anthracite can be used perfectly as a clear separation of a room or area. This concrete bench offers seating for four people at a height of 50 cm, which is also a nice and clear height to indicate a boundary. By placing the bench in front of an entrance or large windows, you subtly build in great security. Ram raids are prevented and burglars are deterred.

Combine oval concrete bench with other concrete benches

Combine this oval standard bench with other concrete benches from HeBlad to

3 April 2025 - Prices subject to change

Our products are delivered from our factory in the Netherlands.



correspondence address

HeBlad - UK

The Balance, 7th floor, Pinfold Street
S1 2GU Sheffield, South Yorkshire
T. 0114 352 0110
info@HeBlad.co.uk
www.HeBlad.co.uk

head office address

HeBlad BV

Diamantweg 22
NL - 5527 LC Hapert

create more seating or provide safety. Place several oval benches for a playful effect and to create a safety obstacle over a greater distance. Or choose the oval standard bench in natural concrete or anthracite concrete.

Delivery of the concrete benches from HeBlad

Due to the size and weight of the concrete bench, extreme care is required for delivery and installation. In addition to production, HeBlad also takes care of delivery and installation. Consult the delivery conditions or contact us for all your questions about the oval standard bench anthracite or HeBlad's other products and services.

Our products are delivered from our factory in the Netherlands.

Registered under: HeBlad BV • HM Revenue and Customs • Ruby House 8 • Ruby Place • AB10 1ZP Aberdeen
VAT Number GB381060225 • EORI Number GB381060225000 • Commercial register (NL) 170 66 364
Rabobank De Kempen, Markt 7, 5531 BA Bladel (NL) • BIC RABONL2U • Branch code RABONL2UXXX • IBAN NL 20 RABO 0107530112 GBP

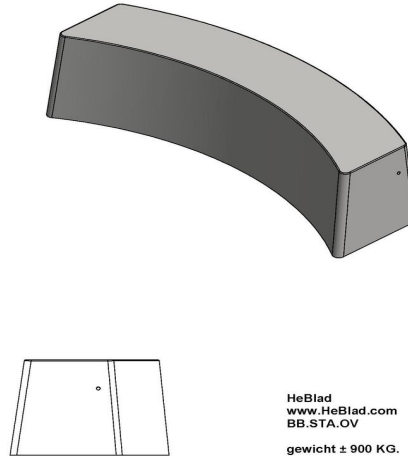
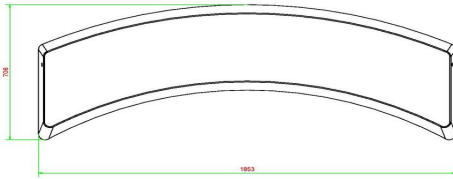

HeBlad
www.HeBlad.com
BB.STA.OV
gewicht ± 900 KG.

Specifications Bench standard oval anthracite

Product code	BB.STA.OV	Material seat	Beton
Colour	Anthracite	Number of seats	4
Dimensions (L x W x H)	185 x 70 x 50 cm	Weight	900 kg
Seat height	50 cm		

Related products



BB.STA.OV



PS.DLA.OV



BB.DL.OV



BB.ST.A



BB.DL.AB

Our products are delivered from our factory in the Netherlands.



Concrete base plate for tennis table

Product code: OP.PP

£ 1,800.00 excl. VAT
(£ 2,160.00 incl. VAT)

Solve any lawn mowing problems in one go with this concrete base plate for the HeBlad ping pong table.

Also suitable for use under a foot volleyball table.

We have developed a concrete base plate with a size of 299 c 179 x 10 cm especially for our rectangular ping pong tables and the ping pong tables with rounded corners. The bottom plate keeps the space under the ping pong table free of weeds and makes the immediate area around the table very easy to keep clean. The base plate also provides the necessary stability. No more sagging gaming table, no more sloping table top: just gaming pleasure.

Supply and installation of concrete base plate for ping pong tables

We can only unload a concrete base plate and products with a base plate if the location is within crane reach, in this case within 5 meters. We can also only supply concrete for this base plate for our ping pong table if we can get close enough. For the exact conditions for delivery of the concrete base plate for ping pong tables, it is advisable to contact the professionals at HeBlad. Because this base plate is placed at ground level, it is important that the truck with loading and unloading crane can reach within 5 meters of the final location. Before the base plate can be laid, the sand bed is first adjusted to height. If the delivery conditions are met, delivery of the concrete base plate comes at no cost for you.

Various versions of concrete base plate for table tennis tables

Because we produce our ping pong tables in different colours, we do the same with the base plates. In addition to this natural concrete base plate, you also have

3 April 2025 - Prices subject to change

Our products are delivered from our factory in the Netherlands.



correspondence address

HeBlad - UK

The Balance, 7th floor, Pinfold Street
S1 2GU Sheffield, South Yorkshire
T. 0114 352 0110
info@HeBlad.co.uk
www.HeBlad.co.uk

head office address

HeBlad BV

Diamantweg 22
NL - 5527 LC Hapert

the option to choose the anthracite concrete base plate. With the same dimensions and specifications, made of coloured concrete. So combine the concrete base plate with other HeBlad game and play tables to your heart's content. Consider, for example, a ping-pong table. A table on which a game of chess, checkers and/or ludo can be played is also ideal.

This way you create an attractive scene in your public space. A place to be together for young and old. A social event where active games, rest and togetherness can be alternated.

Bottom plates will be placed at ground level. When the sand bed is ready at height, we can place the base plates in the right place with the crane, provided this is within 5 meters of our truck.

Our products are delivered from our factory in the Netherlands.

Registered under: HeBlad BV • HM Revenue and Customs • Ruby House 8 • Ruby Place • AB10 1ZP Aberdeen
VAT Number GB381060225 • EORI Number GB381060225000 • Commercial register (NL) 170 66 364
Rabobank De Kempen, Markt 7, 5531 BA Bladel (NL) • BIC RABONL2U • Branch code RABONL2UXXX • IBAN NL 20 RABO 0107530112 GBP

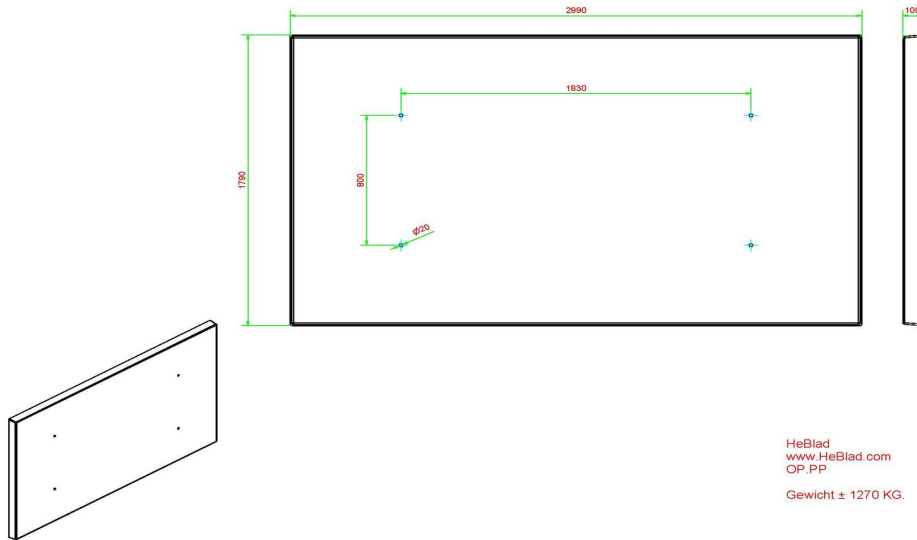

HeBlad
www.HeBlad.com
OP,PP
Gewicht ± 1270 KG.

Specifications Concrete base plate for tennis table

Product code	OP.PP	Finishing base plate	Smooth concrete
Colour	Natural concrete	lifting device	139 x 87 x 99 cm
Dimensions (L x W x H)	299 x 179 x 10 cm	preparation attachment	Holes for bolts M16
Weight	1270 kg		

Related products



PP.AR.BL



PP.AR.GR



PP.BL



PP.GR

Our products are delivered from our factory in the Netherlands.



Concrete base plate for tennis table Anthracite-Concrete

Product code: OP.PP.AB

HeBlad's ping pong tables are legendary, you can find them all over the world. From campsites in France and parks in Belgium to sports fields in the Netherlands, everyone has seen one. Due to their strength and robust appearance, the tables can be placed in any outdoor environment. Guaranteed years of fun for young and old. To keep the base of the ping pong table tidy and to position the table stably, we have designed a base plate especially for our ping pong tables.

Base plate for ping pong tables

With a size of 299 x 179 x 10 cm, you keep the space under the ping pong table rectangular and the ping pong table's rounded corners free of unwanted grass and weeds. The anthracite concrete colour gives a chic look and is made of the same material as HeBlad's other anthracite concrete products. This makes the base plate very suitable for placement under the anthracite concrete ping pong table and the rounded anthracite concrete ping pong table. Because of the size, you can also choose to use the anthracite concrete base plate as a contrast for the natural ping pong tables or the anthracite lacquered ping pong table. This base plate is also used under a HeBlad foot volleyball table.

Delivery of the base plate

The base plate is made from one piece and is supplied with a tap. Therefore, always check in advance whether your location meets the delivery conditions or contact us.

£ 1,900.00 excl. VAT
(£ 2,280.00 incl. VAT)

3 April 2025 - Prices subject to change

Our products are delivered from our factory in the Netherlands.



correspondence address

HeBlad - UK

The Balance, 7th floor, Pinfold Street
S1 2GU Sheffield, South Yorkshire
T. 0114 352 0110
info@HeBlad.co.uk
www.HeBlad.co.uk

head office address

HeBlad BV

Diamantweg 22
NL - 5527 LC Hapert

Base plate and benches.

The base plate provides stability to the products on a less flat or unstable surface. That is why our benches and other gaming tables can also be placed on the base plate. Combinations of different HeBlad products are certainly possible and will complement your site. We provide years of gaming fun and give spectators and passers-by a wonderful moment of rest.

Contact HeBlad

Do you also want to be sure of low-maintenance fun and also add an eye-catcher to your location? We are happy to think along with you about the possibilities and your wishes. Contact us and we will discuss the options.

Our products are delivered from our factory in the Netherlands.

Registered under: HeBlad BV • HM Revenue and Customs • Ruby House 8 • Ruby Place • AB10 1ZP Aberdeen
VAT Number GB381060225 • EORI Number GB381060225000 • Commercial register (NL) 170 66 364
Rabobank De Kempen, Markt 7, 5531 BA Bladel (NL) • BIC RABONL2U • Branch code RABONL2UXXX • IBAN NL 20 RABO 0107530112 GBP

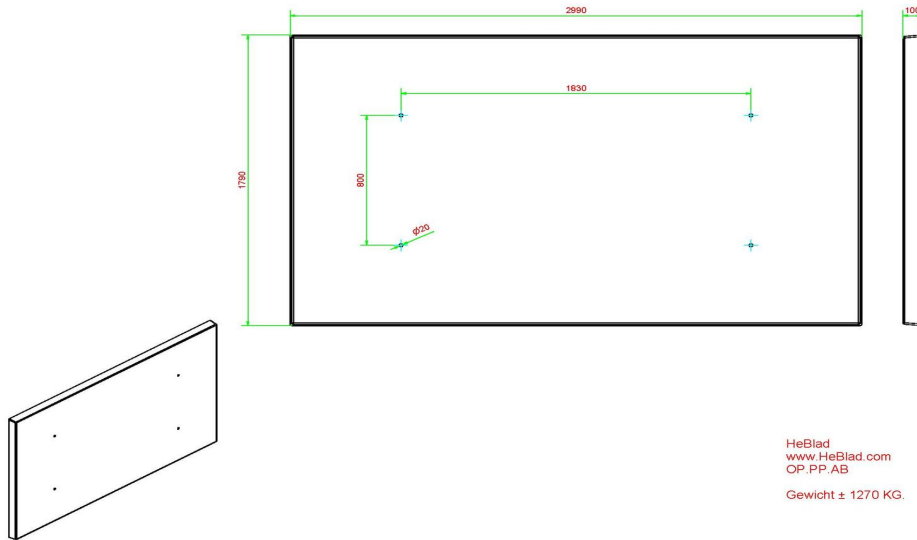

Specifications Concrete base plate for tennis table Anthracite-Concrete

Product code	OP.PP.AB	Finishing base plate	Smooth concrete
Colour	Anthracite concrete	lifting device	139 x 87 x 99 cm
Dimensions (L x W x H)	299 x 179 x 10 cm	preparation attachment	Holes for bolts M16
Weight	1270 kg		

Related products



OP.PP



OP.PS.AB



PP.AR.BL



PP.GR



PP.AR.AB

Our products are delivered from our factory in the Netherlands.



Picnic table DeLuxe Oval Natural Concrete

Product code: PS.DL.OV

£ 2,950.00 excl. VAT
(£ 3,540.00 incl. VAT)

Why an oval picnic set? An oval picnic set gives a charming look to your site thanks to its soft design. The users of the table will be able to see each other better when they take a seat at the table. This natural concrete picnic set is called DeLuxe because of the bamboo seating. Sit comfortably on the soft seating areas that have the same curve of the table, so that they fit perfectly with the oval shape of the tabletop.

The picnic sets from HeBlad

Why choose HeBlad picnic sets? Like all HeBlad products, this oval picnic set is also DeLuxe, cast from one piece of concrete. With a weight of 750 kg, this picnic set is impervious to theft. The materials used, concrete and bamboo, are also resistant to vandalism and extreme weather conditions. The picnic set retains its beautiful colour and shape for years and is easy to maintain.

Installing the DeLuxe oval picnic set

The dimensions of this picnic set are 211 x 205 x 75 cm in total. How much free space do you need to place the table? Take into account sufficient space around the set to be able to move, but also to be able to place the picnic set on your property. If you are unsure whether you have enough space, please read the delivery conditions or contact us. We can tell you whether our truck with a crane can reach your site to install the set.

Base plate for the DeLuxe oval picnic set

3 April 2025 - Prices subject to change

Our products are delivered from our factory in the Netherlands.



correspondence address

HeBlad - UK

The Balance, 7th floor, Pinfold Street
S1 2GU Sheffield, South Yorkshire
T. 0114 352 0110
info@HeBlad.co.uk
www.HeBlad.co.uk

head office address

HeBlad BV

Diamantweg 22
NL - 5527 LC Hapert

For extra strength on the surface, it is advisable to use a base plate. This helps with the stability of the set, but it also helps you make mowing the lawn around the set easier. The base plate is placed at cutting height, so annoying weeds under the table can't grow and the location of the picnic set always looks neat. The base plate is made of the same sturdy concrete as the picnic set and has exactly the right size. The base plate is available separately.

Our products are delivered from our factory in the Netherlands.

Registered under: HeBlad BV • HM Revenue and Customs • Ruby House 8 • Ruby Place • AB10 1ZP Aberdeen
VAT Number GB381060225 • EORI Number GB381060225000 • Commercial register (NL) 170 66 364
Rabobank De Kempen, Markt 7, 5531 BA Bladel (NL) • BIC RABONL2U • Branch code RABONL2UXXX • IBAN NL 20 RABO 0107530112 GBP

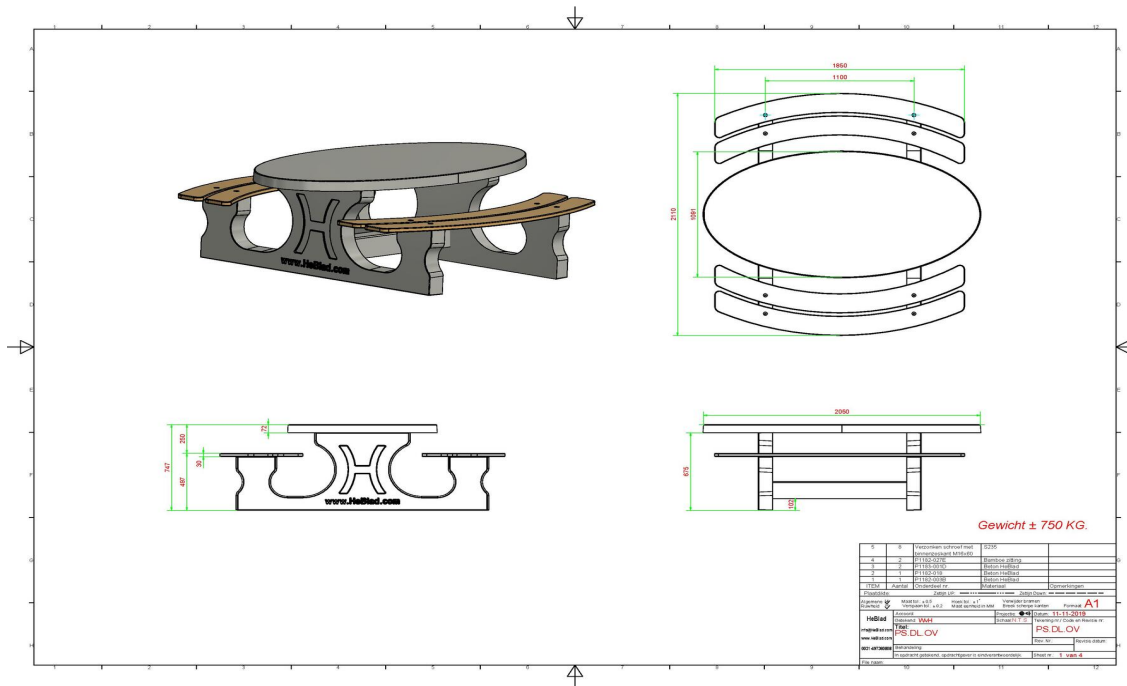

Specifications Picnic table DeLuxe Oval Natural Concrete

Product code	PS.DL.OV	Seat height	50 cm
Colour	Natural concrete	Material seat	Bamboo
Dimensions (L x W x H)	211 x 205 x 75 cm	Distance legs	110 cm (center to center)
Dimensions tabletop (L x W)	205 x 110 cm	Weight	750 kg
Tabletop thickness	7 cm	Number of seats	8

Related products 75 cm



PS.DLAB.OV



PS.DLA.OV



PS.ST



OP.PS



PS.DL.RT

Our products are delivered from our factory in the Netherlands.



Concrete Picnic table DeLuxe Oval Anthracite

Product code: PS.DLA.OV

£ 3,050.00 excl. VAT
(£ 3,660.00 incl. VAT)

What is a picnic set?

A picnic set consists of a table with benches often attached to it, often intended to be (semi-)permanently at an outdoor location. HeBlad manufactures the concrete picnic sets from one piece of cast concrete. The table and benches are made of solid concrete, which gives the set solid strength and makes it impervious to theft or vandalism. You also have the guarantee that this picnic set will provide decades of seating pleasure and will always keep its beautiful appearance.

Where are picnic sets located?

In principle, HeBlad's concrete picnic sets can be placed in any outdoor area, such as schoolyards, parks, gardens, public rest areas, campsites, sports clubs and parking lots. It is important to know the conditions for the delivery of a picnic set. It is important that there is sufficient space to place the set, that our loading and unloading crane can reach the location and that it is indicated on site exactly where the picnic set should be placed.

Picnic set DeLuxe Anthracite Oval

The eye-catching oval picnic set with bamboo seat is lacquered in a beautiful anthracite colour. This gives the robust set a warm appearance that is enhanced by the bamboo used for the seating area of

the set. The concrete, the lacquer layer and the bamboo last a lifetime in all weather conditions. The oval shape gives users a better view of each other and

3 April 2025 - Prices subject to change

Our products are delivered from our factory in the Netherlands.



correspondence address

HeBlad - UK

The Balance, 7th floor, Pinfold Street
S1 2GU Sheffield, South Yorkshire
T. 0114 352 0110
info@HeBlad.co.uk
www.HeBlad.co.uk

head office address

HeBlad BV

Diamantweg 22
NL - 5527 LC Hapert

you have a unique picnic set with a beautiful appearance on your site.

Other models of picnic sets from HeBlad

Picnic sets are available from us in many different designs, both in shape and colour as well as in size and design. In the anthracite lacquered series you can choose from the picnic set standard anthracite, DeLuxe anthracite, standard anthracite oval, DeLuxe anthracite oval, DeLuxe anthracite wheelchair accessible, standard anthracite wheelchair accessible and standard XL anthracite and even more. This same offer also applies to the natural concrete versions and anthracite concrete picnic sets. On the picnic sets page you have a clear view of all types of picnic sets that we offer. If you have any questions about this, please contact us.

Our products are delivered from our factory in the Netherlands.

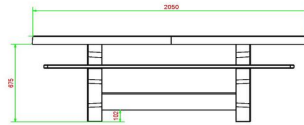
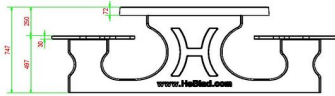
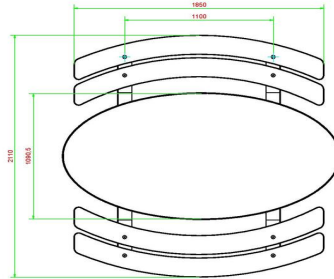
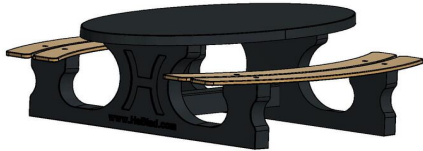

HeBlad
www.HeBlad.com
PS.DLA.OV
± 750 KG.

Specifications Concrete Picnic table DeLuxe Oval Anthracite

Product code	PS.DLA.OV	Seat height	50 cm
Colour	Anthracite lacquered, RAL 7016	Material seat	Bamboo
Dimensions (L x W x H)	211 x 205 x 75 cm	Distance legs	110 cm (center to center)
Dimensions tabletop (L x W)	205 x 110 cm	Weight	750 kg
Tabletop thickness	7 cm	Number of seats	8

Related products



PS.DL.OV

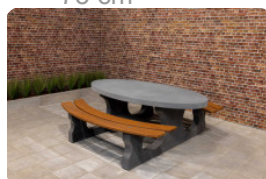

PS.DLAB.OV

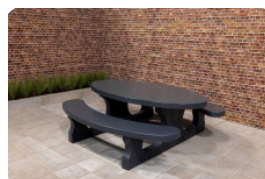

PS.STA.OV



OP.PS.AB



PS.DLA.RT

Our products are delivered from our factory in the Netherlands.



Picnic table DeLuxe Oval Anthracite-Concrete

Product code: PS.DLAB.OV

£ 3,100.00 excl. VAT
(£ 3,720.00 incl. VAT)

DeLuxe at HeBlad means that the seat is made of bamboo. A durable material that remains beautiful and functional even in winter and harsh weather conditions. Bamboo provides slightly more seating comfort than concrete and is a playful addition to the concrete.

What makes HeBlad picnic sets good?

HeBlad picnic sets are made entirely from one piece of concrete, so the benches cannot come loose from the table. Moreover, the weight is so massive that moving the table is impossible and vandalism cannot affect it. The set will also retain its colour if damaged, because the concrete is anthracite coloured throughout.

Thanks to the bamboo seats, visitors also have a comfortable place to sit in winter. The bamboo seats are blindly attached to the concrete surface, so they are not easy to loosen. This means that the picnic set will always retain its beautiful appearance.

Bottom plate picnic sets

For extra stability and a smooth surface for the picnic set, you have the option to order an additional base plate. This is always optional.

Variation in picnic sets

The robustness of the picnic sets is softened in the DeLuxe anthracite concrete oval version by the round shape and the bamboo seat. A playful variation on the standard picnic sets. The oval DeLuxe sets are also available in the colours

3 April 2025 - Prices subject to change

Our products are delivered from our factory in the Netherlands.



correspondence address

HeBlad - UK

The Balance, 7th floor, Pinfold Street
S1 2GU Sheffield, South Yorkshire
T. 0114 352 0110
info@HeBlad.co.uk
www.HeBlad.co.uk

head office address

HeBlad BV

Diamantweg 22
NL - 5527 LC Hapert

anthracite lacquered and natural concrete. When the DeLuxe aspect is removed, we are left with a standard oval. Available in the same three colours, without bamboo seats.

The oval shapes can be perfectly combined with our concrete oval benches. But the curves of the foot volleyball tables also match perfectly with this picnic table.

Contact HeBlad

Do you have any questions about our products, delivery conditions or would you like to place an order? Please contact us or order directly online.

Our products are delivered from our factory in the Netherlands.

Registered under: HeBlad BV • HM Revenue and Customs • Ruby House 8 • Ruby Place • AB10 1ZP Aberdeen
VAT Number GB381060225 • EORI Number GB381060225000 • Commercial register (NL) 170 66 364
Rabobank De Kempen, Markt 7, 5531 BA Bladel (NL) • BIC RABONL2U • Branch code RABONL2UXXX • IBAN NL 20 RABO 0107530112 GBP

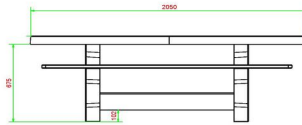
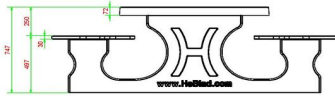
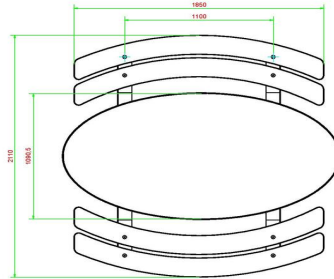
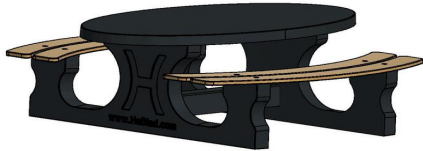

HeBlad
www.HeBlad.com
PS.DLAB.OV
± 750 KG.

Specifications Picnic table DeLuxe Oval Anthracite-Concrete

Product code	PS.DLAB.OV	Seat height	50 cm
Colour	Anthracite concrete	Material seat	Bamboo
Dimensions (L x W x H)	211 x 205 x 75 cm	Distance legs	110 cm (center to center)
Dimensions tabletop (L x W)	205 x 110 cm	Weight	750 kg
Tabletop thickness	7 cm	Number of seats	8

Related products 75 cm



PS.DL.OV



PS.DL.A



PS.STAB.OV



OP.PS.AB



PS.DLAB.RT

Our products are delivered from our factory in the Netherlands.



Bench DeLuxe Oval Natural Concrete

Product code: BB.DL.OV

£ 1,900.00 excl. VAT
(£ 2,280.00 incl. VAT)

The beautiful, playful oval shape of this natural concrete bench makes the bench exceptional. The bamboo seat completes it. DeLuxe is truly a feast for the eyes. A single concrete bench is already a chic addition to your site. A combination of oval concrete benches opens up a world full of possibilities. Consider a combination of a DeLuxe with a standard bench, or a variation in colour.

Did you know that you always receive a significant discount when you purchase two or more products from HeBlad? Worth combining. How about the Concrete Bench DeLuxe Ovaal in anthracite? Both the natural concrete and the anthracite concrete bench are cast from a single piece of concrete. It simply cannot be broken. HeBlad products last a lifetime.

What is an alternative to the DeLuxe concrete bench?

Perhaps you prefer not to have a bamboo seat on the concrete bench. Then a great alternative is the standard oval concrete bench. These benches are also so sturdy that they can even be used to keep buildings safe against ram raids, for example. The simplicity and super high quality of this product make it easy to combine with other HeBlad products.

Questions about the DeLuxe Oval concrete bench

Our team of experts is ready to assist you. Do you have questions about our products? Do you want advice? Are you unsure about your available space? Contact us. We are happy to help you.

3 April 2025 - Prices subject to change

Our products are delivered from our factory in the Netherlands.



correspondence address

HeBlad - UK

The Balance, 7th floor, Pinfold Street
S1 2GU Sheffield, South Yorkshire
T. 0114 352 0110
info@HeBlad.co.uk
www.HeBlad.co.uk

head office address

HeBlad BV

Diamantweg 22
NL - 5527 LC Hapert

Our products are delivered from our factory in the Netherlands.

Registered under: HeBlad BV • HM Revenue and Customs • Ruby House 8 • Ruby Place • AB10 1ZP Aberdeen
VAT Number GB381060225 • EORI Number GB381060225000 • Commercial register (NL) 170 66 364
Rabobank De Kempen, Markt 7, 5531 BA Bladel (NL) • BIC RABONL2U • Branch code RABONL2UXXX • IBAN NL 20 RABO 0107530112 GBP

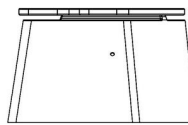
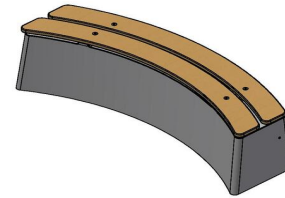
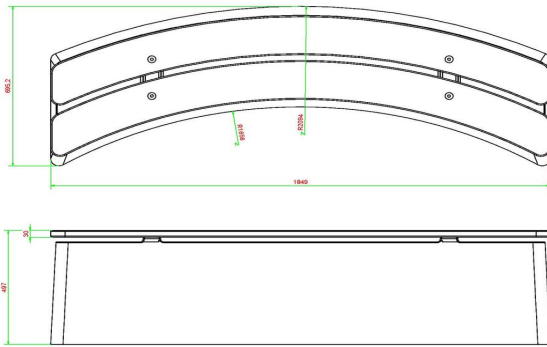

HeBlad
www.HeBlad.com
BB.DL.OV
gewicht ± 825 KG.

Specifications Bench DeLuxe Oval Natural Concrete

Product code	BB.DL.OV	Material seat	Bamboo
Colour	Natural concrete	Number of seats	4
Dimensions (L x W x H)	185 x 70 x 50 cm	Weight	825 kg
Seat height	50 cm		

Related products



BB.DLAB.OV

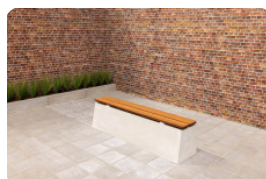

BB.DL



PS.DL.OV



PS.ST.XL



BB.PB.OP

Our products are delivered from our factory in the Netherlands.



Concrete Bench DeLuxe Oval Anthracite

Product code: BB.DLA.OV

£ 1,950.00 excl. VAT
(£ 2,340.00 incl. VAT)

A concrete bench, solid, robust and super strong. Yet elegant and graceful. The DeLuxe Anthracite Oval concrete bench combines beautiful and practical. The warm appearance is due to the sleek anthracite lacquer, the soft bamboo seat and the subtle oval shape. So at first glance it is a modest bench, but that does not apply to its lifespan.

What makes the DeLuxe concrete bench so strong?

The DeLuxe concrete bench, like all HeBlad products, is cast from one piece of concrete. The weight of the bench is therefore 550 kg. Not something that can simply be lifted. The concrete is also resistant to vandalism, the concrete bench is so strong that it is often used as protection for a building, to prevent ram raids. The robustness of the concrete bench makes it ideal for placing in a public outdoor area.

Where are concrete benches?

Public outdoor areas are often decorated with the DeLuxe anthracite oval concrete bench. But the benches are also very popular in private gardens, backyards or in school yards. What about camping areas and sports parks, often in combination with ping-pong tables or picnic sets from HeBlad? Because HeBlad items are produced and designed in the same way, they can all be placed together perfectly.

Concrete bench DeLuxe variants

3 April 2025 - Prices subject to change

Our products are delivered from our factory in the Netherlands.



correspondence address

HeBlad - UK

The Balance, 7th floor, Pinfold Street
S1 2GU Sheffield, South Yorkshire
T. 0114 352 0110
info@HeBlad.co.uk
www.HeBlad.co.uk

head office address

HeBlad BV

Diamantweg 22
NL - 5527 LC Hapert

In addition to the anthracite lacquered version, the DeLuxe oval concrete bench is also available in natural concrete and anthracite concrete. All three versions have the soft bamboo seat in the DeLuxe version. Would you rather not have bamboo on the concrete bench? Then the standard oval concrete benches are exactly what you are looking for. If you prefer straight shapes, you have a wide choice of standard concrete benches in different colours.

Base plate optional

An optional base plate can be ordered for each concrete bench. This gives the bench more stability and makes the space around the concrete bench easier to keep clean. The base plate is always optional and is not automatically supplied with the bench. You can always contact us if you have any questions about the base plate, the concrete bench or other HeBlad products. We'd love to hear from you.

Our products are delivered from our factory in the Netherlands.

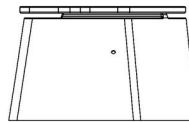
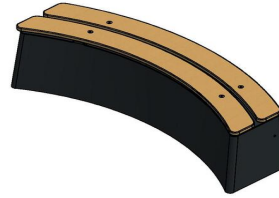
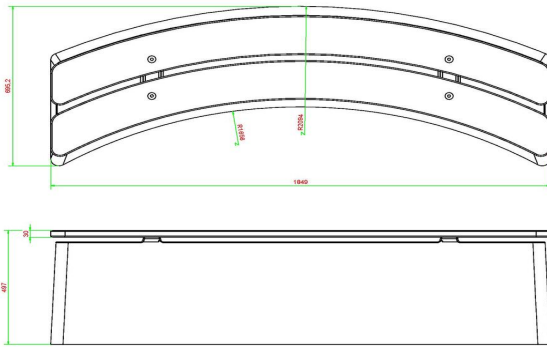

HeBlad
www.HeBlad.com
BB.DLA.OV
gewicht ± 825 KG.

Specifications Concrete Bench DeLuxe Oval Anthracite

Product code	BB.DLA.OV	Material seat	Bamboo
Colour	Anthracite lacquered, RAL 7016	Number of seats	4
Dimensions (L x W x H)	185 x 70 x 50 cm	Weight	825 kg
Seat height	50 cm		

Related products



BB.DL.A



PS.STA.OV



PP.AR.BL



HB.FB.A



GT.CK.G4

Our products are delivered from our factory in the Netherlands.



Bench DeLuxe Oval Anthracite-Concrete

Product code: BB.DLAB.OV

£ 1,975.00 excl. VAT
(£ 2,370.00 incl. VAT)

With the solidity you have come to expect from HeBlad and the beautiful appearance that comes with a chic item. This concrete bench with a bamboo seat has a playful oval shape.

Both the concrete and bamboo are weather-resistant and have a long lifespan. The concrete is coloured anthracite through and through. In the unlikely event of damage, the colour will still be retained.

How big is the DeLuxe concrete bench?

The dimensions of this concrete bench DeLuxe Ovaal are 185 x 70 x 50. The perfect size for a comfortable sitting position. Are you curious whether this bench fits your site? Or would you like to install several benches and do you need help organizing your site? Then be sure to contact us. We are happy to think and calculate along with you.

You can also read in our terms and conditions of delivery what requirements your space must meet in order to be able to install our products.

Why a concrete bench from HeBlad?

HeBlad products are specifically designed to be used outdoors for many years. Intensive use and extreme weather conditions have no influence on the concrete benches. The concrete is cast in one piece and the bamboo is also very strong. HeBlad benches are even used as a barrier for areas, against ram raids in front of a building or to protect trees. These benches are truly that strong and robust. They are also beautiful and a chic addition to any area.

3 April 2025 - Prices subject to change

Our products are delivered from our factory in the Netherlands.



correspondence address

HeBlad - UK

The Balance, 7th floor, Pinfold Street
S1 2GU Sheffield, South Yorkshire
T. 0114 352 0110
info@HeBlad.co.uk
www.HeBlad.co.uk

head office address

HeBlad BV

Diamantweg 22
NL - 5527 LC Hapert

Other products from HeBlad

Because all HeBlad products are made from the same concrete, all items can easily be combined with each other. How about a nice picnic set, sturdy ping pong table or other game table? The possible combinations are endless.

Our products are delivered from our factory in the Netherlands.

Registered under: HeBlad BV • HM Revenue and Customs • Ruby House 8 • Ruby Place • AB10 1ZP Aberdeen
VAT Number GB381060225 • EORI Number GB381060225000 • Commercial register (NL) 170 66 364
Rabobank De Kempen, Markt 7, 5531 BA Bladel (NL) • BIC RABONL2U • Branch code RABONL2UXXX • IBAN NL 20 RABO 0107530112 GBP

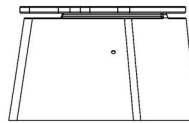
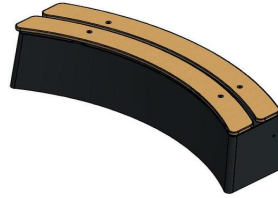
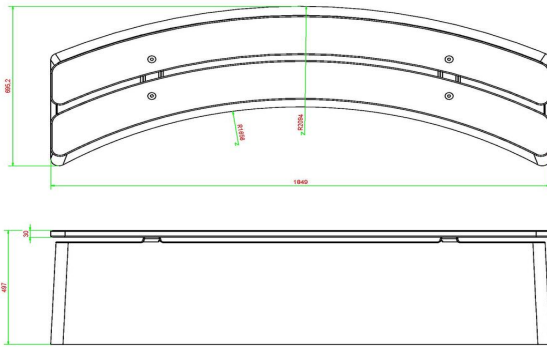

HeBlad
www.HeBlad.com
BB.DLA.OV
gewicht ± 825 KG.

Specifications Bench DeLuxe Oval Anthracite-Concrete

Product code	BB.DLAB.OV	Material seat	Bamboo
Colour	Anthracite concrete	Number of seats	4
Dimensions (L x W x H)	185 x 70 x 50 cm	Weight	825 kg
Seat height	50 cm		

Related products



BB.DL.OV



BB.DLA.OV



BB.PB.OP

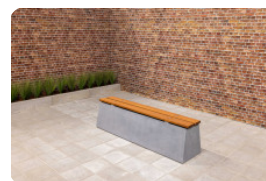

BB.DL.AB



BB.ST.AB

Our products are delivered from our factory in the Netherlands.

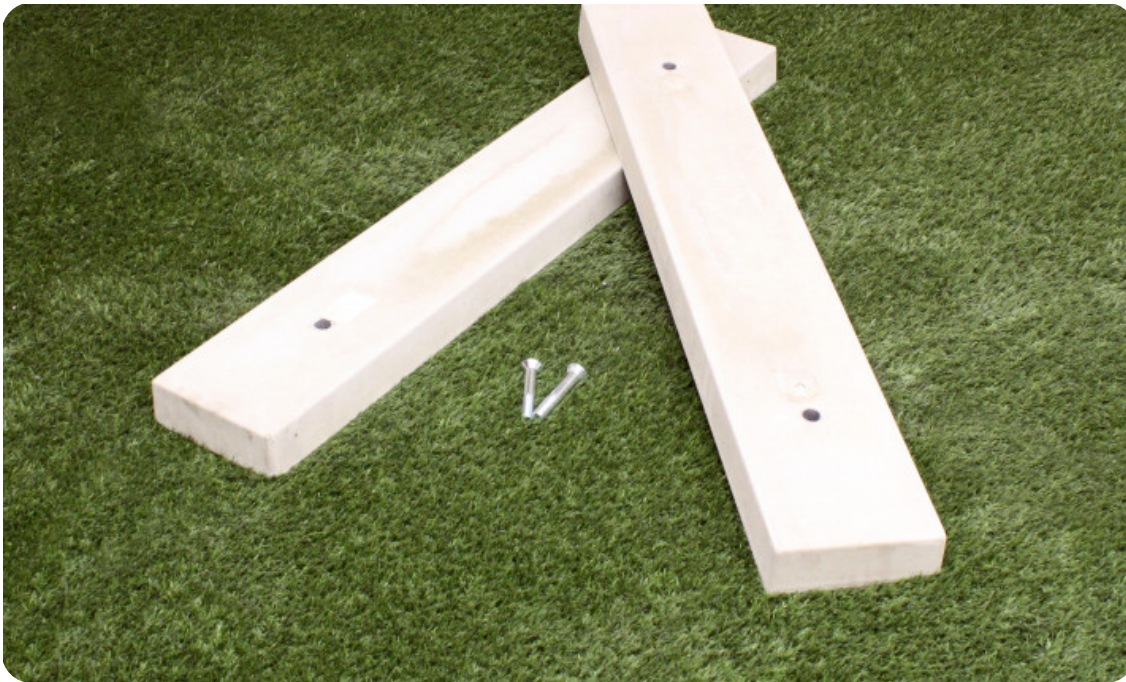

A set of support blocks for different tables

Product code: OV.PP.SET

£ 100.00 excl. VAT
(£ 120.00 incl. VAT)

To better distribute the pressure of HeBlad's robust gaming tables and to prevent the table from sinking into the underlying surface, we have developed bottom feet. The size of each piece in the set is 122.5 x 20 x 6.5 cm and they are therefore suitable for our ping pong tables, foot volleyball tables and table football tables. Because the bottom feet are wider than the legs of the tables, they are less likely to sink into the ground on which they stand. The bottom feet are easy to mount on the bottom of the legs and are made from the well-known sturdy HeBlad concrete.

Set of base feet or base plate

Because our ping pong tables are heavy products, the set of bottom feet may not be sufficient for your surface to prevent collapse. We have devised complete base plates for this purpose, which fit perfectly under our ping-pong tables. By using the base plate you strengthen the surface and protect the ping pong table against unwanted grass or weeds.

If you are unsure about the best solution for you, please contact us. Free delivery applies to both the base set and the base plate in the Netherlands and the average delivery time is only 10 working days. For the UK, this will take a bit longer. On average the delivery time is 6 weeks.

More possibilities with a set of lower feet

Because the set of bases is suitable for several HeBlad gaming tables, you no longer have to worry whether the surface of your location is suitable for a foot volleyball table. This set also makes it possible for you to finally install that football table. Feel free to order the long-cherished ping pong table. Nothing is holding you back anymore.

3 April 2025 - Prices subject to change

Our products are delivered from our factory in the Netherlands.



correspondence address

HeBlad - UK

The Balance, 7th floor, Pinfold Street
S1 2GU Sheffield, South Yorkshire
T. 0114 352 0110
info@HeBlad.co.uk
www.HeBlad.co.uk

head office address

HeBlad BV

Diamantweg 22
NL - 5527 LC Hapert

Contact HeBlad

We'd like to offer everyone a suitable gaming table, picnic set or concrete bench from HeBlad. That is why we are constantly developing and listening to you. By producing the set of base feet and the base plates, more locations have the opportunity to install HeBlad products. Are you curious about our products and would you like to know what is possible in your area? Feel free to contact us.

Our products are delivered from our factory in the Netherlands.

Registered under: HeBlad BV • HM Revenue and Customs • Ruby House 8 • Ruby Place • AB10 1ZP Aberdeen
VAT Number GB381060225 • EORI Number GB381060225000 • Commercial register (NL) 170 66 364
Rabobank De Kempen, Markt 7, 5531 BA Bladel (NL) • BIC RABONL2U • Branch code RABONL2UXXX • IBAN NL 20 RABO 0107530112 GBP

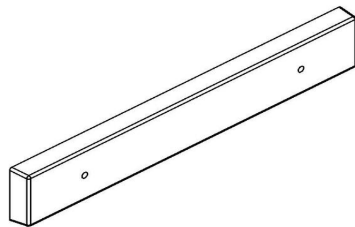
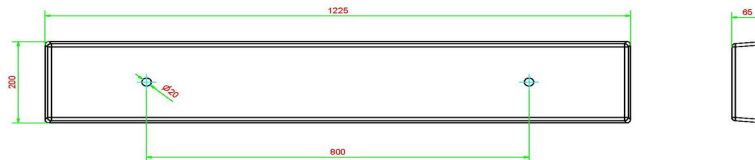

HeBlad
www.HeBlad.com
OV.PP.SET
Gewicht ± 38 KG.
(geleverd per twee)

Specifications A set of support blocks for different tables

Product code	OV.PP.SET
Weight	38 kg

Related products



PS.DL.A



PP.GR



PS.DLAB.RT



PP.AR.BL



PP.R.AB

Our products are delivered from our factory in the Netherlands.

Anthracite-Concrete Base Set for various tables

Product code: OVAB.PP.SET

The weight of the HeBlad game tables is high. Solidity, robustness and resistance to vandalism ensure that the tables last for years and retain their beautiful appearance. However, this can mean that the heavy ping-pong tables, footvolley tables or football tables sink on certain surfaces. How do you prevent such a heavy product from sinking? By placing a base set under the table legs of the tables, more surface area is created and thus the weight of the table is distributed more nicely.

Specifications base set anthracite concrete

This base set is made of anthracite concrete through and through, exactly the same colour anthracite concrete as our game tables are made of. The dimensions of a base piece are 122.5 x 20 x 6.5 cm. As a result, the base protrudes 5 cm all around beyond the original table leg. In what colour are the base sets available? Because we always work with robust concrete and we colour the concrete in its entirety, you can choose between anthracite concrete and natural concrete. For the game tables in the colour natural concrete, you order the set of concrete base pieces for extra load-bearing capacity. With the same properties and specifications, but in a different colour. The right base set for every table.

Base set or base plate

A base set is an inconspicuous aid to provide stability to the gaming table. What if the surface is too soft or uneven? Then play it safe and place the table on a base plate. We have developed a suitable base plate specifically for all gaming tables. This plate can be placed in the surface, so that there are no annoying raised edges, mowing the lawn around the table is no problem and the table is level.

Contact HeBlad about the base set

When do you choose a base set and when is a base plate recommended? Or can the gaming table be placed directly on the surface? We understand that in some cases it is difficult to determine what the best option is. Therefore, if in doubt, always contact us. We are happy to help you with the right advice and explain all the options to you.

£ 1,175.00 excl. VAT

(£ 1,410.00 incl. VAT)

head office address

HeBlad BV
Diamantweg 22
NL - 5527 LC Hapert

Specifications Anthracite-Concrete Base Set for various tables

Product code

OVAB.PP.SET

head office address

HeBlad BV
Diamantweg 22
NL - 5527 LC Hapert

Related products



PS.DLAB.OV



PP.AB



PS.DLAB.GT



PP.R.AB



VV.AB

Our products are delivered from our factory in the Netherlands.



Picnic table DeLuxe Natural Concrete Wheelchair accessible

£ 2,700.00 excl. VAT
(£ 3,240.00 incl. VAT)

Product code: PS.DL.RT

The DeLuxe concrete picnic table from HeBlad is chic, sturdy and wheelchair-friendly. Like all other HeBlad products, HeBlad picnic sets are made from one piece of concrete, extremely strong and a true feast for the eyes. We believe that everyone should be able to sit at this beautiful set, so we made the DeLuxe concrete picnic set wheelchair accessible.

Special dimensions for wheelchair-friendly picnic table

To ensure that almost every wheelchair can actually sit at the picnic table instead of next to it, the tabletop has been placed higher and made longer. This gives a free space of 60 cm deep and 70 cm high at the end of the table. The overhang of the tabletop is extremely sturdy and can therefore withstand a blow.

Picnic set with bamboo seat gives a luxurious look

At HeBlad, DeLuxe stands for a refined seating area made of bamboo. The DeLuxe wheelchair accessible picnic set is made of extremely strong concrete and elegantly finished with bamboo seats. Just like concrete, bamboo is not sensitive to weather influences, so the materials remain beautiful and strong. The bamboo offers the user a soft surface for extra seating comfort. Various benches from HeBlad are also available in the DeLuxe version and can be perfectly combined with this picnic set. The picnic set DeLuxe anthracite concrete wheelchair accessible also fits nicely with the natural concrete version. Same specifications, but in a darker colour.

Combine the picnic table with a concrete bench or game table

3 April 2025 - Prices subject to change

Our products are delivered from our factory in the Netherlands.



correspondence address

HeBlad - UK

The Balance, 7th floor, Pinfold Street
S1 2GU Sheffield, South Yorkshire
T. 0114 352 0110
info@HeBlad.co.uk
www.HeBlad.co.uk

head office address

HeBlad BV

Diamantweg 22
NL - 5527 LC Hapert

Have you ever thought about placing several picnic sets together? This gives you the opportunity to mix colour and design. The DeLuxe wheelchair accessible picnic set can also be perfectly positioned near game tables such as foot volleyball, ping pong table or table football. By placing a wheelchair-accessible picnic set near a game table, the wheelchair user can also be part of the fun.

Please contact us for more information

To be sure whether your site is suitable for the DeLuxe wheelchair accessible picnic set, we recommend contacting HeBlad. No one knows our products better than our own professionals. We know the delivery conditions, carefully calculate your discount when you purchase two or more products and look at the options you have for placing HeBlad products.

* The base plate is optional

Our products are delivered from our factory in the Netherlands.

Registered under: HeBlad BV • HM Revenue and Customs • Ruby House 8 • Ruby Place • AB10 1ZP Aberdeen
VAT Number GB381060225 • EORI Number GB381060225000 • Commercial register (NL) 170 66 364
Rabobank De Kempen, Markt 7, 5531 BA Bladel (NL) • BIC RABONL2U • Branch code RABONL2UXXX • IBAN NL 20 RABO 0107530112 GBP

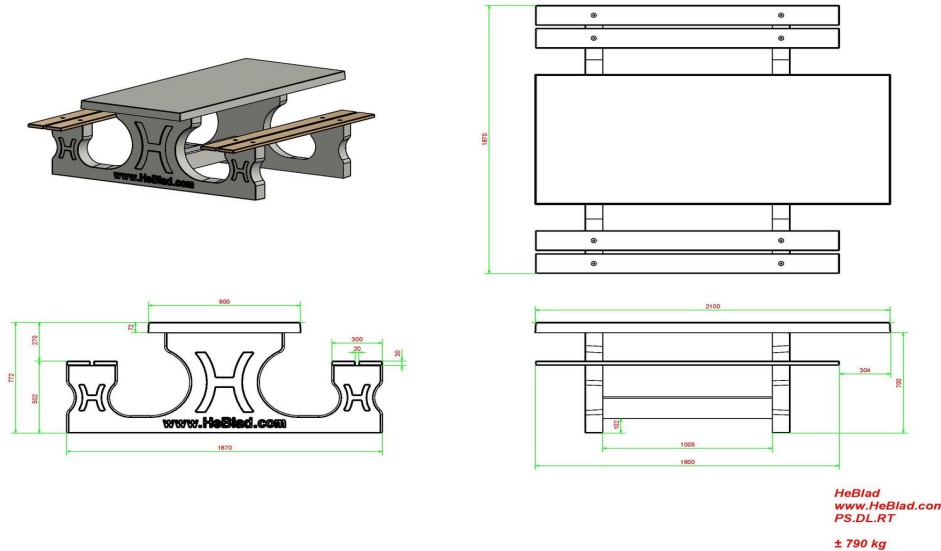

Specifications Picnic table DeLuxe Natural Concrete Wheelchair accessible

Product code	PS.DL.RT	Seat height	50 cm
Colour	Natural concrete	Material seat	Bamboo
Dimensions (L x W x H)	210 x 187 x 77 cm	Distance legs	111 cm (center to center)
Dimensions tabletop (L x W)	210 x 90 cm	Weight	790 kg
Tabletop thickness	7 cm	Number of seats	7

Related products 77 cm



PS.DLAB.RT



PS.DLA.RT



PS.ST.XL



OP.PS



PS.DL

Our products are delivered from our factory in the Netherlands.



Concrete Picnic table DeLuxe Anthracite Wheelchair accessible

£ 2,900.00 excl. VAT
(£ 3,480.00 incl. VAT)

Product code: PS.DLA.RT

Because the benches are attached to a regular picnic table, a wheelchair user cannot easily sit at the picnic table. HeBlad has designed a picnic table that is wheelchair friendly by extending the tabletop on one side. This extension creates a free space of 60 cm deep and 71 cm high at the end of the picnic set. This makes the picnic table wheelchair accessible, the wheelchair user can simply sit at the table instead of next to it. How a small adjustment creates so many more opportunities.

Can the picnic table be placed outside in a wheelchair-accessible way?

All HeBlad products are specifically designed and produced to last a lifetime outdoors. The robust concrete and weather-resistant bamboo are the materials that can withstand all types of weather, even the extreme ones. The materials retain their beautiful appearance, but also their strength. The picnic sets, just like the game tables, benches and ping-pong tables, are also impervious to vandalism. Thanks to the weight and the fact that the products are made in one piece, the tables cannot be moved or damaged. This picnic table therefore remains wheelchair accessible, because the table cannot be rotated and the top cannot be broken off. Wheelchair friendly and lovely to sit at a beautiful picnic table in the open air.

In what colour can the picnic set be ordered?

This anthracite wheelchair accessible picnic set is painted in the colour RAL 7016. But the natural and anthracite concrete picnic sets are also available in a wheelchair-friendly variant. These variants have the same strength, specifications

3 April 2025 - Prices subject to change

Our products are delivered from our factory in the Netherlands.



correspondence address

HeBlad - UK

The Balance, 7th floor, Pinfold Street
S1 2GU Sheffield, South Yorkshire
T. 0114 352 0110
info@HeBlad.co.uk
www.HeBlad.co.uk

head office address

HeBlad BV

Diamantweg 22
NL - 5527 LC Hapert

and dimensions. The choice of colour is yours!

Combine the picnic set wheelchair accessible

Because HeBlad products are all made from concrete and made in our own factory, the products can be combined very nicely with one another. Feel free to place a ludo table, ping pong table or checkers bench near your picnic table. Your site will only become more beautiful and visitors will not be bored.

Contact HeBlad

We only work with professionals who know their stuff. So please contact us if you have any questions, we will be happy to help you.

Our products are delivered from our factory in the Netherlands.

Registered under: HeBlad BV • HM Revenue and Customs • Ruby House 8 • Ruby Place • AB10 1ZP Aberdeen
VAT Number GB381060225 • EORI Number GB381060225000 • Commercial register (NL) 170 66 364
Rabobank De Kempen, Markt 7, 5531 BA Bladel (NL) • BIC RABONL2U • Branch code RABONL2UXXX • IBAN NL 20 RABO 0107530112 GBP

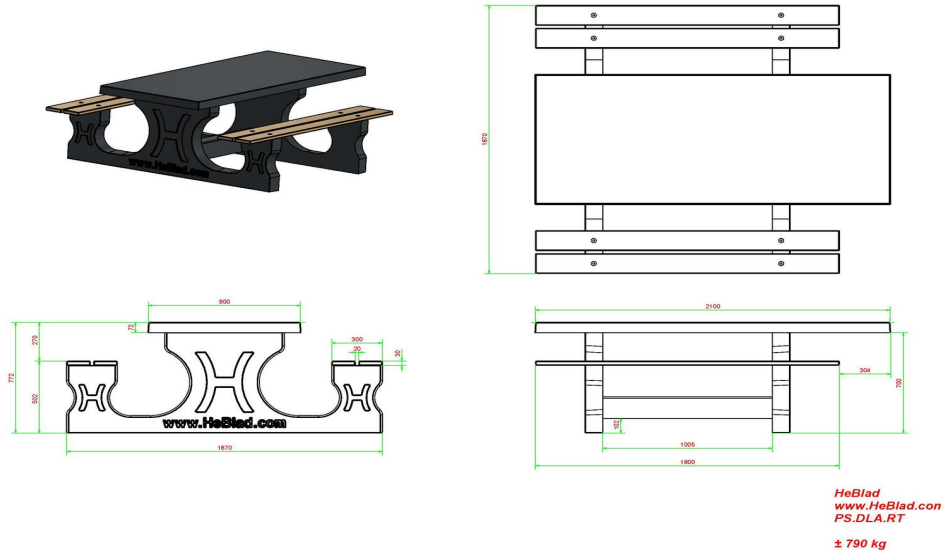

Specifications Concrete Picnic table DeLuxe Anthracite Wheelchair accessible

Product code	PS.DLA.RT	Seat height	50 cm
Colour	Anthracite lacquered, RAL 7016	Material seat	Bamboo
Dimensions (L x W x H)	210 x 187 x 77 cm	Distance legs	111 cm (center to center)
Dimensions tabletop (L x W)	210 x 90 cm	Weight	790 kg
Tabletop thickness	7 cm	Number of seats	7

Related products



PS.DL.OV

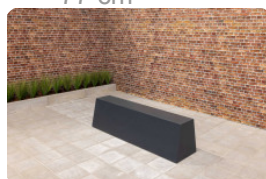

BB.ST.A



HB.FB.A



PP.GR



OP.PS.AB

Our products are delivered from our factory in the Netherlands.



Picnic table DeLuxe Anthracite-Concrete Wheelchair accessible

£ 2,950.00 excl. VAT
(£ 3,540.00 incl. VAT)

Product code: PS.DLAB.RT

A small adjustment makes a big difference. This certainly applies to this Concrete Picnic Table DeLuxe in the colour Anthracite Concrete. With a minor adjustment, this table is a wheelchair-friendly picnic table. With the solidity of the robust concrete and the gracefulness of the bamboo seats, this DeLuxe anthracite concrete picnic table is made wheelchair-friendly. By lifting the tabletop a little higher and making the top longer at the end, almost any wheelchair user can sit at the picnic table. The adjustment to the tabletop creates an extra space with ample space for a wheelchair user.

Which picnic table is the best choice?

HeBlad has several picnic sets in its range. In addition to the DeLuxe anthracite concrete picnic table, we also have the DeLuxe anthracite picnic table lacquered and the DeLuxe natural concrete picnic table also available in a wheelchair-friendly version. At HeBlad, DeLuxe means that the picnic set is finished with a beautiful bamboo seating area instead of concrete seats. Both concrete and bamboo are perfectly resistant to weather influences and retain their luxurious appearance.

Can the picnic set be combined?

The standard oval picnic sets are a nice alternative to the solid and strong standard picnic sets, which are made from one piece of concrete. That same robust concrete is used in a graceful manner in a playful oval shape. This version gives that extra bit of chic to the picnic set. To provide space for many visitors at the same time, HeBlad has designed the standard XL picnic set. An eye-catcher

3 April 2025 - Prices subject to change

Our products are delivered from our factory in the Netherlands.



correspondence address

HeBlad - UK

The Balance, 7th floor, Pinfold Street
S1 2GU Sheffield, South Yorkshire
T. 0114 352 0110
info@HeBlad.co.uk
www.HeBlad.co.uk

head office address

HeBlad BV

Diamantweg 22
NL - 5527 LC Hapert

on your site that will be used frequently.

Which game tables can be placed outside?

All HeBlad products are made to last for years in the outdoors. So feel free to combine the picnic sets with the HeBlad game tables. All HeBlad products are robust and solid and resistant to weather and damage. For example, choose a concrete ping pong table, chess, checkers or ludo table or the popular foot volleyball table.

Contact HeBlad

A passionate team of employees is waiting for you to contact us with your questions or orders. Ask all your questions about the accessibility of your site, the installation of products, the delivery conditions and of course we are happy to discuss discount options. We know what your options are and will give you the right advice about safety, accessibility and, for example, installing a base plate. We'd love to hear from you.

The base plate is always optional and must be ordered separately.

Our products are delivered from our factory in the Netherlands.

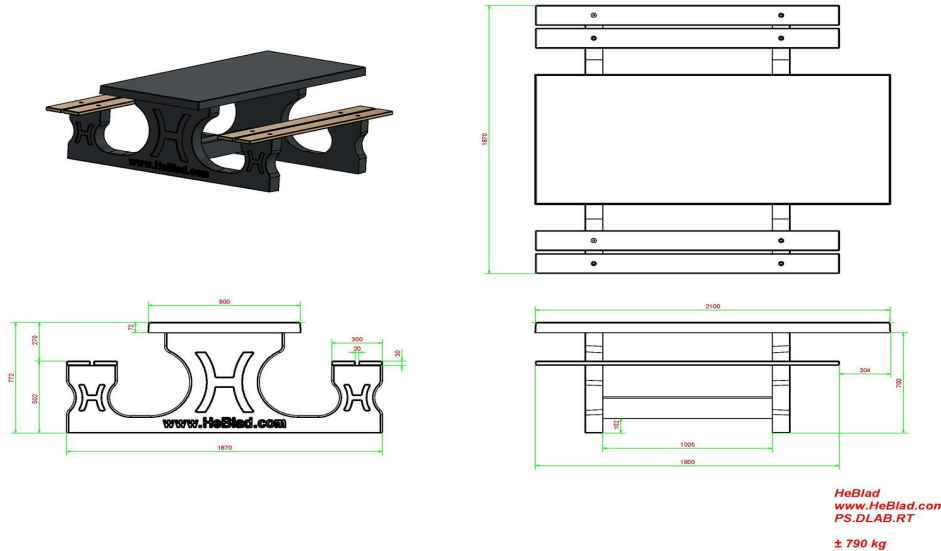

Specifications Picnic table DeLuxe Anthracite-Concrete Wheelchair accessible

Product code	PS.DLAB.RT	Seat height	50 cm
Colour	Anthracite concrete	Material seat	Bamboo
Dimensions (L x W x H)	210 x 187 x 77 cm	Distance legs	111 cm (center to center)
Dimensions tabletop (L x W)	210 x 90 cm	Weight	790 kg
Tabletop thickness	7 cm	Number of seats	7

Related products 77 cm



PS.DL.RT



PS.DLA.RT



PS.STAB.XL



OP.PS.AB



PS.DLAB

Our products are delivered from our factory in the Netherlands.



Bamboo planks

Product code: PS.Plank

£ 60.00 excl. VAT
(£ 72.00 incl. VAT)

The name DeLuxe stands for bamboo in HeBlad's concrete benches. Bamboo seating and, in some cases, also a bamboo backrest. Bamboo is durable, weather-resistant and strong. Unfortunately, bamboo is less resistant to vandalism than concrete. The bamboo planks can be damaged by, for example, being cut into. The weather also has more influence on bamboo than on concrete. Therefore, the concrete bench or picnic set may still be in excellent condition, but the bamboo parts need to be replaced. If this is ever the case, you won't need to purchase an entirely new bench.

Straight bamboo planks for renewal

By replacing the bamboo plank or planks that are damaged or weathered, you will have a completely new-looking bench or seating area. Choose the sustainable and less expensive solution. Can the bamboo planks also be placed on other benches? You can also use this straight bamboo plank to replace planks on benches that do not come from HeBlad. In this case it's good to keep in mind that the shelves are designed for HeBlad products and that the mounting holes are pre-drilled at a distance of 111 cm center to center.

Delivery of the straight bamboo plank

When will the straight bamboo plank be delivered? The plank will be sent to you immediately after placing your order. This allows you to quickly install a new plank if you notice damage or weathering. Use an Allen key to assemble the bamboo plank. You can order this Allen key separately from HeBlad, if you do not have one yourself.

Contact HeBlad

3 April 2025 - Prices subject to change

Our products are delivered from our factory in the Netherlands.



correspondence address

HeBlad - UK

The Balance, 7th floor, Pinfold Street
S1 2GU Sheffield, South Yorkshire
T. 0114 352 0110
info@HeBlad.co.uk
www.HeBlad.co.uk

head office address

HeBlad BV

Diamantweg 22
NL - 5527 LC Hapert

You may have questions about dismantling and assembling the bamboo plank or the accessories needed to replace the bamboo plank. Please feel free to contact us, we will be happy to help you.

Our products are delivered from our factory in the Netherlands.

Registered under: HeBlad BV • HM Revenue and Customs • Ruby House 8 • Ruby Place • AB10 1ZP Aberdeen
VAT Number GB381060225 • EORI Number GB381060225000 • Commercial register (NL) 170 66 364
Rabobank De Kempen, Markt 7, 5531 BA Bladel (NL) • BIC RABONL2U • Branch code RABONL2UXXX • IBAN NL 20 RABO 0107530112 GBP

Specifications Bamboo planks

Product code	PS.Plank
Material	FSC bamboo
Dimensions (L x W x H)	180 x 14 x 3 cm
Weight	12.6 kg

head office address

HeBlad BV
Diamantweg 22
NL - 5527 LC Hapert

Related products



BB.DL.A



PS.Plank.OV



BB.DL.OP



PS.DLA.OV



PS.DL

Our products are delivered from our factory in the Netherlands.



Set of oval bamboo planks

Product code: PS.Plank.OV

£ 170.00 excl. VAT
(£ 204.00 incl. VAT)

The DeLuxe benches and picnic sets oval from HeBlad are equipped with bamboo seats. Wonderfully soft to the buttocks and very chic to the eye. Bamboo is a material that is specifically used to last a long time outdoors in all weather conditions. Despite the strength of the material, bamboo is slightly more sensitive than concrete to extreme weather influences, damage and vandalism. That is why you can order the oval planks for the DeLuxe picnic set separately from us. This way you will have a new, sturdy picnic set in no time.

Where are HeBlad's picnic sets located?

You can find HeBlad products everywhere in Europe, sometimes even beyond. Our products are often found at campsites, such as the well-known table tennis tables. We regularly install football tables or foot volleyball tables at sports clubs. Our other gaming tables are also immensely popular with a large audience. Because the tables are supplied complete with associated accessories, several players can always participate at the same time and the tables are also very popular in parks or in a home or business situation.

How to order the set of oval planks or other products

Our website makes it very simple and clear to place an order immediately. When you order multiple products at the same time, you will automatically receive a nice discount on the second and subsequent products. If you have any questions about your order, the space you have available, delivery times or about HeBlad itself, please contact us. We would like to take you into the world of robust gaming tables.

3 April 2025 - Prices subject to change

Our products are delivered from our factory in the Netherlands.

Specifications Set of oval bamboo planks

Product code	PS.Plank.OV
Dimensions (L x W x H)	185 x 79 x 3 cm
Material	FSC bamboo
Weight	2 x 12 kg

head office address

HeBlad BV
Diamantweg 22
NL - 5527 LC Hapert

Related products

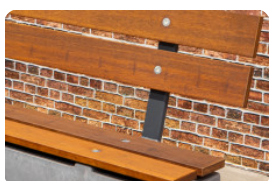

PS.Plank



BB.DL.OV



BB.DLA.OV



BB.STA.OV

Our products are delivered from our factory in the Netherlands.



Parkbench Duo Concrete

Product code: BB.PB.DUO

£ 2,075.00 excl. VAT
(£ 2,490.00 incl. VAT)

What a beautiful bench to provide multiple seats in a practical way. While taking up almost the same amount of space as a regular bench, you create twice as much space to sit. With the hardness of the concrete and the high quality of the wood, this concrete park bench with duo seat has a long lifespan and is not sensitive to weather influences.

Combine the concrete park bench with a duo seat

This park bench offers many possibilities in itself. For example, line them up to form a train and let children play this way. By combining this park bench with other benches from HeBlad, you can create a variety of seating options on your property. To please the more active visitor to your playground, park or garden, HeBlad offers a wide choice of game tables, ping-pong tables and foot volleyball tables.

Table tennis tables go perfectly with a concrete park bench with a duo seat

The concrete table tennis tables from HeBlad are solid and cannot be broken. By placing the park bench near the ping pong table, you'll always have room for the audience during the ping pong game. Both products are made of hard concrete and will last for many many years. Because the table tennis tables are available in many different colours and shapes, there is always a table to suit your taste and can be perfectly combined with the park bench.

Concrete park bench with duo seat and game tables

3 April 2025 - Prices subject to change

Our products are delivered from our factory in the Netherlands.

With a wide range of game tables, we always have a game table that fits very well with the park bench. Do you like natural? Then the natural concrete chess bench is a nice addition to the concrete park bench with duo seat in natural concrete. The chess table in natural concrete also has the same natural concrete appearance.

Do you prefer to combine your park bench with other colours of concrete? That is also no problem for HeBlad. For example, choose the anthracite concrete chess bench or the anthracite concrete checkers bench. The possibilities are endless.

Additional options:

- When placing these duo benches in locations that are more susceptible to vandalism, you can choose to mount an "Anchoring set" on the underside of the legs and collapse them. If you want to use this anchor set on an existing schoolyard, you must dig 2 holes in the sidewalk and pour the anchors with a bucket of concrete after attaching them.
- If you want to place these duo benches on a lawn, we advise you to use concrete base plates. In the photo of the product you see the "Picnic set base plate". This creates a large concrete surface in the grass, which is not always desirable, especially when placing several tables in a row.
- This duo bench also fits on a "Concrete Underfoot Set". By using this underfoot set, more grass remains visible, so that a park does not look like a concrete pavement. These concrete foundation plates protrude 5 cm all around compared to the legs, so that the grass that is difficult to mow cannot directly reach the legs.
- If you have any questions about this, please do not hesitate to contact us. Our professionals are always happy to help you!

Our products are delivered from our factory in the Netherlands.

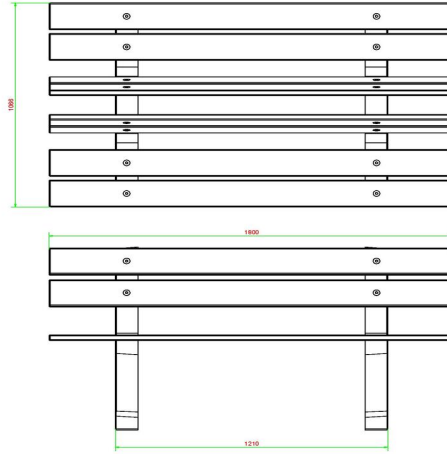
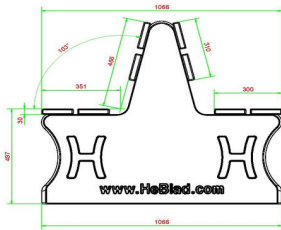
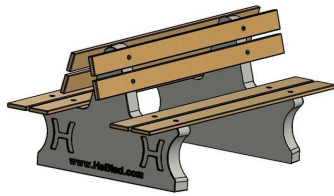

HeBlad
www.HeBlad.com
BB.PB.DUO
±350 KG

Specifications Parkbench Duo Concrete

Product code	BB.PB.DUO	Material seat	Bamboo
Colour	Natural concrete	Seating corner	103 degrees
Dimensions (L x W x H)	180 x 106 x 94 cm	Number of seats	8
Seat height	50 cm	Weight	350 kg
Dimensions seat	180 x 30 cm	Distance legs	111 cm (center to center)

Related products



BB.DLA.OP



BB.PBAB.DUO



PS.Plank

Our products are delivered from our factory in the Netherlands.



Park Bench Duo anthracite-concrete

Product code: BB.PBAB.DUO

£ 2,125.00 excl. VAT
(£ 2,550.00 incl. VAT)

A beautiful and practical addition to your property, playground or park. With its anthracite concrete colour, this concrete bench is a pleasure to the eyes and inviting to visitors to take a seat. The bamboo seat and backrest give the park bench a chic look, without sacrificing quality and durability.

Variants of the concrete park bench anthracite concrete

A fun way to create plenty of seating space is by placing several concrete benches together as a whole, or combine this variant with different versions of the park bench, to play with contrast. The other available version is a concrete bench in natural concrete, which has the same strength and specifications, but is lighter in colour.

Of the anthracite concrete colour appeals to you, we've got a wide selection to offer you. Take the standard anthracite oval concrete bench. With its robust appearance and playful oval shape, you provide your site with an attractive concrete seating area. The standard anthracite concrete bench is the straight version of this and can also be used as a solid blockage in addition to a seat.

Ping pong tables from HeBlad near the concrete park bench with duo seating

HeBlad is known for its solid ping pong tables. These are cast from one piece of concrete and can be found on many schoolyards and campsites. The anthracite concrete ping pong table matches perfectly with the concrete park bench with duo seat in anthracite concrete. This table offers the excitement you would expect from a ping pong table, but has a calm, natural appearance. For a little more safety, the rounded anthracite concrete table tennis table is the best option. The

3 April 2025 - Prices subject to change

Our products are delivered from our factory in the Netherlands.



correspondence address

HeBlad - UK

The Balance, 7th floor, Pinfold Street
S1 2GU Sheffield, South Yorkshire
T. 0114 352 0110
info@HeBlad.co.uk
www.HeBlad.co.uk

head office address

HeBlad BV

Diamantweg 22
NL - 5527 LC Hapert

rounded corners are specifically designed to prevent accidents. To be able to play table tennis with several people at the same time, HeBlad has designed the ping pong table round anthracite concrete. This guarantees a diversity of gaming options.

Wondering which concrete park bench or ping pong table suits you?

Are you curious about HeBlad products and would you like to know which benches or game tables suit your site? Please contact one of our specialists. We are happy to advise you and discuss your wishes and options. Additional options:

- When placing these duo benches in locations that are more susceptible to vandalism, you can choose to mount an "Anchoring set" on the underside of the legs and collapse them. If you want to use this anchor set on an existing schoolyard, you must dig 2 holes in the sidewalk and pour the anchors with a bucket of concrete after attaching them.
- If you want to place these duo benches on a lawn, we advise you to use concrete base plates. These create a large concrete surface in the grass, which is not always desirable, especially when placing several products next to each other.
- This duo bench also fits on a "Concrete Underfoot Set". By using this underfoot set, more grass remains visible, so that a park does not look like a concrete pavement. These concrete foundation plates protrude 5 cm all around compared to the legs, so that the grass that is difficult to mow has no chance directly against the legs.

Our products are delivered from our factory in the Netherlands.

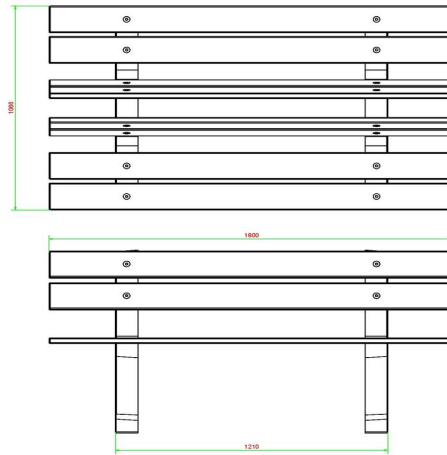
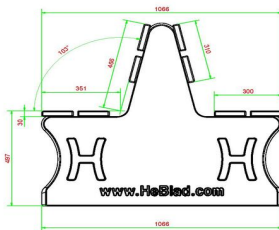
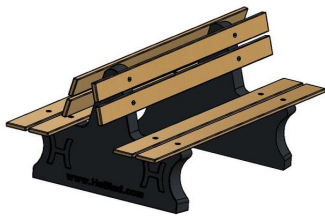

HeBlad
www.HeBlad.com
BB.PBAB.DUO
±350 KG

Specifications Park Bench Duo anthracite-concrete

Product code	BB.PBAB.DUO	Material seat	Bamboo
Colour	Anthracite concrete	Seating corner	103 degrees
Dimensions (L x W x H)	180 x 106 x 94 cm	Number of seats	8
Seat height	50 cm	Weight	350 kg
Dimensions seat	180 x 30 cm	Distance legs	111 cm (center to center)

Related products



BB.DLA.OP



BB.PB.DUO



PS.Plank

Our products are delivered from our factory in the Netherlands.

Park bench Duo set of 4 pieces

Product code: BB.PB.DUO.SET4

Unlike most HeBlad products, the duo park bench is supplied in a set of 4 pieces, in separate parts on a pallet. This way the concrete benches can be delivered more easily and you can decide where to place the park benches. You can also first store the pallets and give them a permanent place on your site at a later time. How is the park bench delivered? We always recommend that you first read the terms and conditions of delivery. Because of the size and weight of our products, we deliver with a loading/unloading crane from our truck. Accessibility for the truck and possible accessibility for the pallet truck is essential. You can also watch the video we made of a delivery, to give you an idea of

how a delivery works. The videos can be found at the bottom of this page.

Park bench concrete and bamboo

What materials are HeBlad park benches made of? These Duo Park Benches are constructed with a concrete base. The seat and backrest are made of bamboo. Both bamboo and concrete are weather resistant and retain their beautiful appearance and comfort. The mounting materials used to assemble the park benches are Allen screws that are resistant to all weather conditions.

Assembly Park bench Duo set of 4 pieces

How is the duo park bench assembled? With the included assembly instructions you can easily mount the concrete benches yourself. You determine the location and position of the benches yourself. The benches are placed with their backs against each other. If you have any questions about the delivery, installation or assembly of the park benches, please contact us. We are happy to help you.

£ 4,650.00 head office address

(£ 5,580.00 incl. VAT)

HeBlad BV
Diamantweg 22
NL - 5527 LC Hapert

Specifications Park bench Duo set of 4 pieces

head office address

Product code	BB.PB.DUO.SET4	Material seat	Bamboo	HeBlad BV
Colour	Natural concrete	Number of seats	8	Diamantweg 22
Dimensions (L x W x H)	180 x 106 x 94 cm	Seating corner	103 degrees	NL - 5527 LC Hapert
Seat height	50 cm	Weight	4 x 350 kg	
Dimensions seat	180 x 30 cm	Distance legs	111 cm (center to center)	

Related products



BB.PBAB.OP.SET4



BB.PB.DUO



BB.PBAB.DUO



BB.PB.OP



BB.PBAB.OP

Our products are delivered from our factory in the Netherlands.

Park bench Duo in Anthracite-Concrete set of 4set of 4 pieces

Product code: BB PBAB DUO.SET

The HeBlad Park Bench Duo as a set of four is delivered to you as a construction kit with clear assembly instructions and the necessary mounting materials and tools. How are the park benches packaged? The materials are stacked on a pallet and covered with protection against damage and moisture.

Where can the duo park benches be placed?

The duo park benches look great on a schoolyard, so that students can sit together in groups during breaks. But they are also great in parking lots, on festival grounds, outdoor recreational areas, campsites or other places where groups of people often come together.

Park bench or picnic set

HeBlad's concrete benches always guarantee intensive use and are a nice addition to your site. If you have a lot of space and often have several visitors at the same time, you can also opt for a picnic set from HeBlad. Why a picnic set? In addition to a comfortable seat, a picnic set also offers a large table top. It takes up slightly more space than a regular concrete bench, but also offers more options.

Why a park bench from HeBlad?

HeBlad means solid, robust, functional and at the same time beautiful and contemporary. We are the manufacturer of concrete game tables, benches, picnic sets and owe our fame to our table tennis tables. We manage everything ourselves. We provide advice, production and delivery ourselves with a team of enthusiastic professionals. You will find our products all over the world, always shining outdoors. Are you also curious about our products? Contact us and we will discuss the options with you.

£ 4,850.00 excl. VAT

(£ 5,820.00 incl. VAT)

head office address

HeBlad BV
Diamantweg 22
NL - 5527 LC Hapert

3 April 2025 - Prices subject to change

Our products are delivered from our factory in the Netherlands.

Specifications Park bench Duo in Anthracite-Concrete set of 4set of 4 pieces

head office address

Product code	BB.PBAB.DUO.SET	Material seat	Bamboo
Colour	Anthracite concrete	Seating corner	103 degrees
Dimensions (L x W x H)	180 x 106 x 94 cm	Number of seats	8
Seat height	50 cm	Weight	4 x 350 kg
Dimensions seat	180 x 30 cm	Distance legs	111 cm (center to center)

HeBlad BV
Diamantweg 22

Related products



BB.PB.OP.SET4



BB.PB.DUO



BB.PBAB.OP



BB.PB.OP

Our products are delivered from our factory in the Netherlands.



Picnic set Standard 246cm

Product code: PS.ST.246

£ 3,050.00 excl. VAT
(£ 3,660.00 incl. VAT)

Sleek, robust, rock-solid and soft in colour. This standard picnic set in natural concrete colour is no less than 246 cm long, which means that more people can sit on this set than on a regular picnic set. This makes this large picnic table ideal for schoolyards or parks. Is a base plate needed for the large picnic set? Due to the weight of the table, it is important to check the surface for suitability. A possible base plate could be a solution against sinking or to make it easier to level the picnic set.

Is there a possibility for a discount?

Did you know that when you order a second or subsequent product from HeBlad in one order, you will automatically receive a discount? It is worth combining with other HeBlad game tables or ordering multiple picnic sets at the same time.

Combine and maximize

For example, by placing a multi-games table next to this large picnic set, you create even more seating for your visitors. But at the same time you give visitors the opportunity to play different games. For each integrated game in the multi-game table, you will receive a free set of associated accessories, such as chess pieces, dice and pawns.

Contact HeBlad

We understand that our offering consists of a wide variety. That's because we don't want you to lack anything to provide your site with a solid addition that will last for years. Do you have any questions about our products, their delivery or would you like advice first? Then be sure to contact us. We are happy to help you.

3 April 2025 - Prices subject to change

Our products are delivered from our factory in the Netherlands.

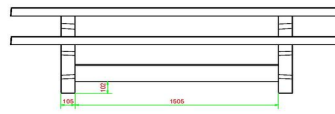
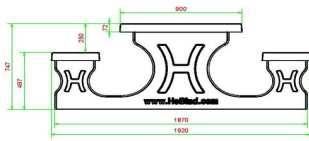
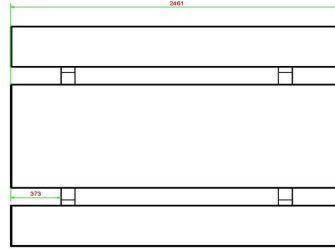
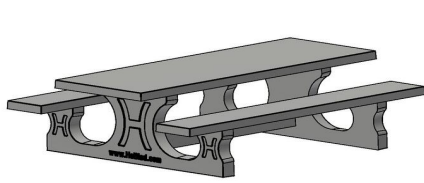

HeBlad
www.HeBlad.com
PS.ST.246
± 1100 KG.

Specifications Picnic set Standard 246cm

Product code	PS.ST.246	Seat height	50 cm
Colour	Natural concrete	Material seat	Beton
Dimensions (L x W x H)	246 x 193 x 75 cm	Distance legs	161 cm (hart op hart)
Dimensions tabletop (L x W)	246 x 90 cm	Weight	1135 kg
Tabletop thickness	7 cm	Number of seats	10
Height tabletop	75 cm		

Related products



PS.DL.246



PS.DLA.246



OP.PS.246



OP.PS.AB.246

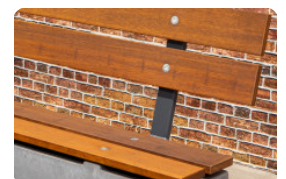

PS.Plank

Our products are delivered from our factory in the Netherlands.



Picnic set Standard Anthracite 246cm

Product code: PS.STA.246

£ 3,150.00 excl. VAT
(£ 3,780.00 incl. VAT)

3 April 2025 - Prices subject to change

Our products are delivered from our factory in the Netherlands.

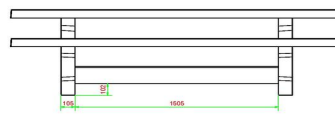
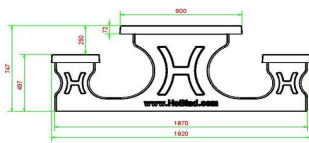
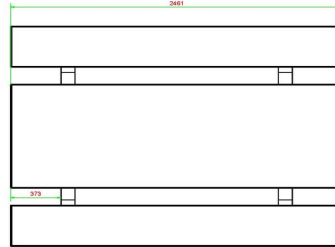
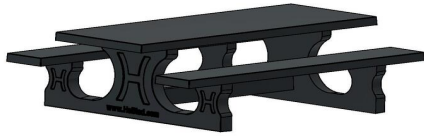

HeBlad
www.HeBlad.com
PS.STA.246
± 1100 KG.

Specifications Picnic set Standard Anthracite 246cm

Product code	PS.STA.246	Seat height	50 cm
Colour	Anthracite lacquered, RAL 7016	Material seat	Beton
Dimensions (L x W x H)	246 x 193 x 75 cm	Distance legs	161 cm (hart op hart)
Dimensions tabletop (L x W)	246 x 90 cm	Weight	1135 kg
Tabletop thickness	7 cm	Number of seats	10

Height tabletop 75 cm

Related products



PS.ST.A



PS.DLA.246



PS.STAB.246



PS.ST.246



PS.STA.XL

Our products are delivered from our factory in the Netherlands.



Picnic set Standard Anthracite-Concrete 246cm

Product code: PS.STAB.246

£ 3,200.00 excl. VAT
(£ 3,840.00 incl. VAT)

3 April 2025 - Prices subject to change

Our products are delivered from our factory in the Netherlands.

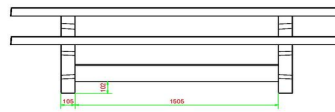
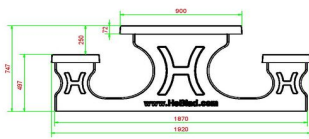
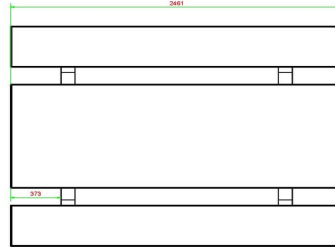

HeBlad
www.HeBlad.com
PS.STAB.246
± 1100 KG.

Specifications Picnic set Standard Anthracite-Concrete 246cm

Product code	PS.STAB.246	Seat height	50 cm
Colour	Anthracite concrete	Material seat	Beton
Dimensions (L x W x H)	246 x 193 x 75 cm	Distance legs	161 cm (hart op hart)
Dimensions tabletop (L x W)	246 x 90 cm	Weight	1135 kg
Tabletop thickness	7 cm	Number of seats	10

Related products 75 cm



PS.DL.246



PS.DLA.246



OP.PS.AB.246

Our products are delivered from our factory in the Netherlands.



Bamboo planks

Product code: PS.Plank

£ 60.00 excl. VAT
(£ 72.00 incl. VAT)

The name DeLuxe stands for bamboo in HeBlad's concrete benches. Bamboo seating and, in some cases, also a bamboo backrest. Bamboo is durable, weather-resistant and strong. Unfortunately, bamboo is less resistant to vandalism than concrete. The bamboo planks can be damaged by, for example, being cut into. The weather also has more influence on bamboo than on concrete. Therefore, the concrete bench or picnic set may still be in excellent condition, but the bamboo parts need to be replaced. If this is ever the case, you won't need to purchase an entirely new bench.

Straight bamboo planks for renewal

By replacing the bamboo plank or planks that are damaged or weathered, you will have a completely new-looking bench or seating area. Choose the sustainable and less expensive solution. Can the bamboo planks also be placed on other benches? You can also use this straight bamboo plank to replace planks on benches that do not come from HeBlad. In this case it's good to keep in mind that the shelves are designed for HeBlad products and that the mounting holes are pre-drilled at a distance of 111 cm center to center.

Delivery of the straight bamboo plank

When will the straight bamboo plank be delivered? The plank will be sent to you immediately after placing your order. This allows you to quickly install a new plank if you notice damage or weathering. Use an Allen key to assemble the bamboo plank. You can order this Allen key separately from HeBlad, if you do not have one yourself.

Contact HeBlad

3 April 2025 - Prices subject to change

Our products are delivered from our factory in the Netherlands.



correspondence address

HeBlad - UK

The Balance, 7th floor, Pinfold Street
S1 2GU Sheffield, South Yorkshire
T. 0114 352 0110
info@HeBlad.co.uk
www.HeBlad.co.uk

head office address

HeBlad BV

Diamantweg 22
NL - 5527 LC Hapert

You may have questions about dismantling and assembling the bamboo plank or the accessories needed to replace the bamboo plank. Please feel free to contact us, we will be happy to help you.

Our products are delivered from our factory in the Netherlands.

Registered under: HeBlad BV • HM Revenue and Customs • Ruby House 8 • Ruby Place • AB10 1ZP Aberdeen
VAT Number GB381060225 • EORI Number GB381060225000 • Commercial register (NL) 170 66 364
Rabobank De Kempen, Markt 7, 5531 BA Bladel (NL) • BIC RABONL2U • Branch code RABONL2UXXX • IBAN NL 20 RABO 0107530112 GBP

Specifications Bamboo planks

Product code	PS.Plank
Material	FSC bamboo
Dimensions (L x W x H)	180 x 14 x 3 cm
Weight	12.6 kg

head office address

HeBlad BV
Diamantweg 22
NL - 5527 LC Hapert

Related products



BB.DL.A



PS.Plank.OV



BB.DL.OP

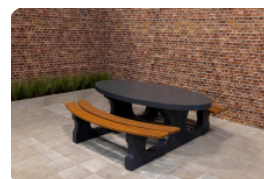

PS.DLA.OV



PS.DL

Our products are delivered from our factory in the Netherlands.



Set of oval bamboo planks

Product code: PS.Plank.OV

£ 170.00 excl. VAT
(£ 204.00 incl. VAT)

The DeLuxe benches and picnic sets oval from HeBlad are equipped with bamboo seats. Wonderfully soft to the buttocks and very chic to the eye. Bamboo is a material that is specifically used to last a long time outdoors in all weather conditions. Despite the strength of the material, bamboo is slightly more sensitive than concrete to extreme weather influences, damage and vandalism. That is why you can order the oval planks for the DeLuxe picnic set separately from us. This way you will have a new, sturdy picnic set in no time.

Where are HeBlad's picnic sets located?

You can find HeBlad products everywhere in Europe, sometimes even beyond. Our products are often found at campsites, such as the well-known table tennis tables. We regularly install football tables or foot volleyball tables at sports clubs. Our other gaming tables are also immensely popular with a large audience. Because the tables are supplied complete with associated accessories, several players can always participate at the same time and the tables are also very popular in parks or in a home or business situation.

How to order the set of oval planks or other products

Our website makes it very simple and clear to place an order immediately. When you order multiple products at the same time, you will automatically receive a nice discount on the second and subsequent products. If you have any questions about your order, the space you have available, delivery times or about HeBlad itself, please contact us. We would like to take you into the world of robust gaming tables.

3 April 2025 - Prices subject to change

Our products are delivered from our factory in the Netherlands.

Specifications Set of oval bamboo planks

Product code	PS.Plank.OV
Dimensions (L x W x H)	185 x 79 x 3 cm
Material	FSC bamboo
Weight	2 x 12 kg

head office address

HeBlad BV
Diamantweg 22
NL - 5527 LC Hapert

Related products

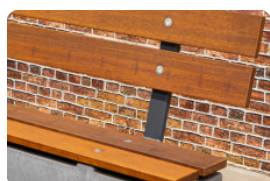

PS.Plank



BB.DL.OV



BB.DLA.OV



BB.STA.OV

Our products are delivered from our factory in the Netherlands.



Set of pawns with a dice

Product code: GT.LD.Pieces

£ 10.00 excl. VAT
(£ 12.00 incl. VAT)

When you order a gaming table from HeBlad, you will always receive a set of the necessary accessories. Every ludo table or multi-game table comes with a set of pawns and die. This set is made of wood and the pawns have a height of four centimeters. In order to play the game properly, the set of pawns consists of four times four pawns of different colours.

The whole is housed in a transparent plexiglass cube. After arranging the pieces, you can leave the die in it and shake this container and then place it on the table. Loose set of pawns with die

At HeBlad we understand that pawns and dice can be lost, damaged or simply insufficient for the number of participants. That is why we also offer the set of pawns with die separately.

Accessories from HeBlad

We have included the most vulnerable parts for each gaming table in our range of accessories. Play unlimited table tennis on ping pong tables with plastic bats in sets of four or ten. Or treat yourself to the starter pack of bats and balls. Of course, the ping pong balls are also available separately in different quantities. HeBlad's chess tables, chess benches, ludo tables, checkers tables and checkers benches are supplied with chess pieces or checkers. You can order a separate set if your set is lost or damaged or as a spare set. Do you have a damaged or lost part or accessory to your HeBlad gaming table? Please contact us so that we can help you replace or repair the part.

Game tables and pawns with dice

All HeBlad gaming tables include the necessary accessories. Even with a multi-game table that contains no fewer than three games. You will receive all

3 April 2025 - Prices subject to change

Our products are delivered from our factory in the Netherlands.



correspondence address

HeBlad - UK

The Balance, 7th floor, Pinfold Street
S1 2GU Sheffield, South Yorkshire
T. 0114 352 0110
info@HeBlad.co.uk
www.HeBlad.co.uk

head office address

HeBlad BV

Diamantweg 22
NL - 5527 LC Hapert

pawns, dice, chess pieces or checkers with this versatile game table and you can order all accessories separately or in addition to each other. You can easily order all accessories online, but you are also cordially invited to contact us to place your order or ask your question.

Our products are delivered from our factory in the Netherlands.

Registered under: HeBlad BV • HM Revenue and Customs • Ruby House 8 • Ruby Place • AB10 1ZP Aberdeen
VAT Number GB381060225 • EORI Number GB381060225000 • Commercial register (NL) 170 66 364
Rabobank De Kempen, Markt 7, 5531 BA Bladel (NL) • BIC RABONL2U • Branch code RABONL2UXXX • IBAN NL 20 RABO 0107530112 GBP

Specifications Set of pawns with a dice

Product code	GT.LD.Pieces
Material	Wood
Height pawns	3 cm

head office address

HeBlad BV
Diamantweg 22
NL - 5527 LC Hapert

Related products

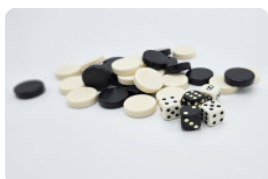

GT.BG.pieces



GT.CK.Pieces



GT.LD.AB4



GT.LD.4



PS.DL.GT.132

Our products are delivered from our factory in the Netherlands.



Set of chessmen

Product code: GT.CH.Pieces

£ 19.00 excl. VAT
(£ 22.80 incl. VAT)

A chess game without chess pieces is not a game. That is why all HeBlad chess tables, chess benches and multi-game tables are supplied with the corresponding chess pieces as standard. Because the chess pieces can of course be damaged or lost, you can easily order a separate set of chess pieces online.

Specifications set of chess pieces

The set of chess pieces consists of 32 items, 16 pieces in the white, light colour and 16 pieces in the darker, brown colour. The chess pieces are made of wood, the height of the King is almost 8 cm and all pieces have felt on the underside to prevent scratches on the chessboard. Once we have received your order, we will send you the set within two working days.

Chess pieces for chess table and multi game table

As with every chess game, chess pieces are needed, so we supply pawns with a die for every ludo table. We supply checkers with every checkers game and with every multi-game table all the accessories the table needs for optimal gaming fun. All these attributes can be ordered separately via the website or by contacting us. To play safely at the football tables, we have eye protectors and rubber bumpers available. The table football balls can also be ordered separately. This also applies to the bar, the football figures and the handle, so that you can always play table football.

Contact HeBlad

For your convenience and speed, you can easily order all your products online via the website. Just like HeBlad's products, our service is also robust and reliable. With us you can be assured of the right advice, clear agreements and production

3 April 2025 - Prices subject to change

Our products are delivered from our factory in the Netherlands.



correspondence address

HeBlad - UK

The Balance, 7th floor, Pinfold Street
S1 2GU Sheffield, South Yorkshire
T. 0114 352 0110
info@HeBlad.co.uk
www.HeBlad.co.uk

head office address

HeBlad BV

Diamantweg 22
NL - 5527 LC Hapert

and delivery with care. Thanks to years of experience, we know exactly which game table, concrete bench, picnic set or ping-pong table best suits your site. Please feel free to contact us with any questions about HeBlad products, delivery conditions, specifications or if you have any ideas. We have a team of skilled employees ready to assist you.

Our products are delivered from our factory in the Netherlands.

Registered under: HeBlad BV • HM Revenue and Customs • Ruby House 8 • Ruby Place • AB10 1ZP Aberdeen
VAT Number GB381060225 • EORI Number GB381060225000 • Commercial register (NL) 170 66 364
Rabobank De Kempen, Markt 7, 5531 BA Bladel (NL) • BIC RABONL2U • Branch code RABONL2UXXX • IBAN NL 20 RABO 0107530112 GBP

Specifications Set of chessmen

Product code	GT.CH.Pieces
Material	Wood
King height	7,7 cm

head office address

HeBlad BV
Diamantweg 22
NL - 5527 LC Hapert

Related products



GT.CH.G4



HB.FB.A



BB.CH



GT.CH.AB2

Our products are delivered from our factory in the Netherlands.



Set of checkers/drafts

Product code: GT.CK.Pieces

£ 12.00 excl. VAT
(£ 14.40 incl. VAT)

When you order one of our beautiful checkers tables, it will be delivered with 1 set of checkers. Because without checkers, there is no checkers game! Each set of checkers contains 20 light and 20 dark stones. If you ever want to order new checkers, you can also order a separate set of checkers from HeBlad. Simply online or by contacting us.

Receive checkers at a discount

HeBlad offers a very attractive discount when you order multiple products in addition to your checkers. This way you can save up a lot of money on your set of checkers. Once your order has been placed, delivery will take place quickly, because we can often deliver from stock.

Checkers for the HeBlad game tables

The choice is huge in checkers tables or benches at HeBlad. Are you looking for a robust appearance? Then the checkers bank is a good choice. The bench is made in one piece and is available in the natural concrete checkerboard version, with a natural light appearance. The anthracite concrete version has a dark colour based on coloured concrete. Both the inside and outside of the bench have the same anthracite concrete colour.

In addition to checkers benches, we also make checkers tables. The seats are separate from the game table. The checkers tables are available as an anthracite-concrete checkers table for 4 people or an anthracite-concrete checkers table for 2 people. If you prefer a lighter colour for the game table, then the natural concrete checkers table for 4 people or the natural concrete checkers table for 2 people may suit your tastes better.

3 April 2025 - Prices subject to change

Our products are delivered from our factory in the Netherlands.



correspondence address

HeBlad - UK

The Balance, 7th floor, Pinfold Street
S1 2GU Sheffield, South Yorkshire
T. 0114 352 0110
info@HeBlad.co.uk
www.HeBlad.co.uk

head office address

HeBlad BV

Diamantweg 22
NL - 5527 LC Hapert

Checkers and chess pieces

Would you like to place a chess table or bench in addition to your checkers table or bench? That would be a very nice addition! Of course, when you order a chess bench or chess table, you will receive a set of chess pieces as a gift. Wondering what the best gaming table is for your location? Please contact us, we will be happy to inform you about the possibilities.

For a separate order, the following applies: as soon as we receive the order, the package will be shipped to you within 2 working days.

Our products are delivered from our factory in the Netherlands.

Registered under: HeBlad BV • HM Revenue and Customs • Ruby House 8 • Ruby Place • AB10 1ZP Aberdeen
VAT Number GB381060225 • EORI Number GB381060225000 • Commercial register (NL) 170 66 364
Rabobank De Kempen, Markt 7, 5531 BA Bladel (NL) • BIC RABONL2U • Branch code RABONL2UXXX • IBAN NL 20 RABO 0107530112 GBP

Specifications Set of checkers/drafts

Product code	GT.CK.Pieces
Material	Wood

head office address

HeBlad BV
Diamantweg 22
NL - 5527 LC Hapert

Related products



GT.CK.AB2



GT.CK.AB4



HB.FB.A



BB.CK

Our products are delivered from our factory in the Netherlands.



Backgammon stones and dice

Product code: GT.BG.pieces

£ 19.00 excl. VAT
(£ 22.80 incl. VAT)

A board game cannot be played without associated accessories. For the backgammon game, checkers in black and white and a set of five dice are indispensable. That is why we supply these stones and dice free of charge with the delivery of a multi-game table with backgammon board or another game table in which the backgammon game is integrated. If the accessories are lost or damaged, they can easily be ordered via this website.

Backgammon accessories and game rules

How is the backgammon game played? One player plays with the white stones and the opponent plays with black. The points on the board and the throwing of the dice determine the order in which the stones are moved across the board in order to be the first to get all the stones to the other side. Players can hit each other's stones.

Backgammon and other gaming tables

The game of backgammon dates back to Mesopotamia and is approximately 5,000 years old. Of course, the game has evolved over time to the version we know today.

The great thing about a HeBlad game table is that they can easily be combined with one another. For example, consider a combination of the backgammon table with a foot volleyball table. In this way you create a beautiful balance between mental sport and physical sport. A game as old as time, combined with a relatively new game. Or consider a combination with one of the banks. Thanks to the unity in design and colour, all HeBlad products can easily be combined with each other.

3 April 2025 - Prices subject to change

Our products are delivered from our factory in the Netherlands.



correspondence address

HeBlad - UK

The Balance, 7th floor, Pinfold Street
S1 2GU Sheffield, South Yorkshire
T. 0114 352 0110
info@HeBlad.co.uk
www.HeBlad.co.uk

head office address

HeBlad BV

Diamantweg 22
NL - 5527 LC Hapert

Contact HeBlad

Would you like to decorate your site with a game table or concrete bench from HeBlad? Please contact us. We are happy to think along with you and know exactly what the possibilities are for your space.

Our products are delivered from our factory in the Netherlands.

Registered under: HeBlad BV • HM Revenue and Customs • Ruby House 8 • Ruby Place • AB10 1ZP Aberdeen
VAT Number GB381060225 • EORI Number GB381060225000 • Commercial register (NL) 170 66 364
Rabobank De Kempen, Markt 7, 5531 BA Bladel (NL) • BIC RABONL2U • Branch code RABONL2UXXX • IBAN NL 20 RABO 0107530112 GBP

Specifications Backgammon stones and dice

Product code	GT.BG.pieces
Material	Kunststof

head office address

HeBlad BV
Diamantweg 22
NL - 5527 LC Hapert

Related products



GT.BG.2



GT.BG.4



BB.BG



BB.BG.AB



PS.DL.GT.134

Our products are delivered from our factory in the Netherlands.



Bench DeLuxe with backrest Natural Concrete

Product code: BB.DL.ML

£ 1,975.00 excl. VAT
(£ 2,370.00 incl. VAT)

DeLuxe at HeBlad means that the seat is made of high-quality bamboo. Comfortable to sit on, a pleasure to the eyes and resistant to all weather influences. In addition to a bamboo seat, this DeLuxe concrete bench is also equipped with a bamboo backrest. A real eye-catcher on your site. The concrete bench is executed in natural concrete, cast from one piece of robust material. The seat and backrest are firmly mounted onto the concrete. To give the bench more strength to the surface, we recommend that you place the concrete bench on a base plate.

DeLuxe concrete bench without backrest

The concrete bench with a backrest offers more seating comfort and may be more pleasant to look at, but it can be more susceptible to vandalism because it can be pushed over with brute force. This can be prevented by using the base plate, placing the bench with the backrest against a wall or placing two benches with the backrests against each other. We have also developed the Concrete Bench DeLuxe without a backrest. This bench has the same natural concrete base and the same bamboo seat. This is what makes the concrete impervious to destruction.

Combine the concrete benches from HeBlad

HeBlad products are often made of rock-solid concrete. Because the Concrete Bench DeLuxe with backrest is also available in the colours anthracite and anthracite concrete, various combinations with the Concrete Bench DeLuxe are possible. You can also combine the Concrete Bench DeLuxe with the concrete

3 April 2025 - Prices subject to change

Our products are delivered from our factory in the Netherlands.



correspondence address

HeBlad - UK

The Balance, 7th floor, Pinfold Street
S1 2GU Sheffield, South Yorkshire
T. 0114 352 0110
info@HeBlad.co.uk
www.HeBlad.co.uk

head office address

HeBlad BV

Diamantweg 22
NL - 5527 LC Hapert

bench standard, which has the same soft natural colour, and is also insensitive to destruction. For a more playful twist, you can choose the standard oval concrete bench.

Game tables and concrete benches

The combination of the HeBlad concrete benches with the HeBlad game tables guarantees a chic, lasting decoration of your site with endless seating and gaming pleasure. Please contact us if you would like more information about HeBlad products or if you would like to know which game tables and benches are suitable for your site.

Our products are delivered from our factory in the Netherlands.

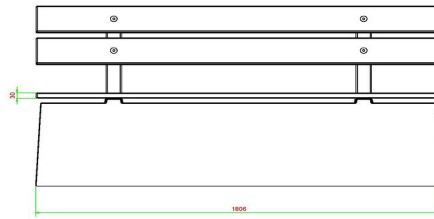
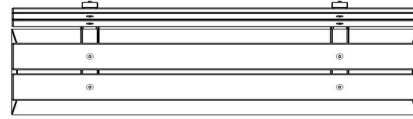
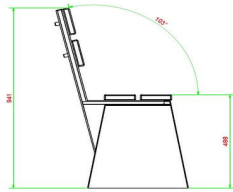
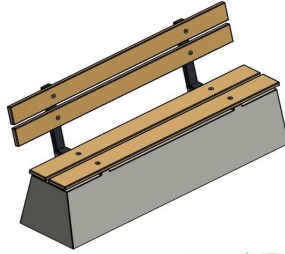

HeBlad
www.HeBlad.com
BB.DL.ML
gewicht ± 480 KG.

Specifications Bench DeLuxe with backrest Natural Concrete

Product code	BB.DL.ML	Material seat	Bamboo
Colour	Natural concrete	Seating corner	103 degrees
Dimensions (L x W x H)	180 x 45 x 95 cm	Number of seats	4
Seat height	48,5 cm	Weight	630 kg
Dimensions seat	180 x 30 cm		

Related products



BB.PB.OP



BB.DLAB.ML



BB.PBAB.OP



BB.DL.OV

Our products are delivered from our factory in the Netherlands.



Concrete bench DeLuxe with backrest Anthracite

Product code: BB.DLA.ML

£ 2,025.00 excl. VAT
(£ 2,430.00 incl. VAT)

Do you also like to offer you and your visitors comfortable seating? The Concrete Bench DeLuxe Anthracite with backrest provides seating pleasure and is a beautiful addition to your site. The base is made of robust concrete, but is chicly finished with two-component paint in anthracite. The sleek anthracite colour matches perfectly with the bamboo from which the backrest and seating area are made. The concrete, paint and bamboo are suitable to be left outside for years without the concrete bench becoming weathered. HeBlad products are specifically designed for outdoor installation.

The concrete benches from HeBlad

Just like the Concrete Bench DeLuxe Anthracite with backrest, the other benches from HeBlad are also made from one piece of robust concrete. Resistant to weather influences and vandalism, guaranteed seating pleasure and no loss of the beautiful appearance. Do you not like the bamboo decoration of the concrete bench? Then we have various concrete benches for you, without bamboo seat and/or backrest.

Concrete benches in different shapes

What do you think of the standard anthracite oval concrete bench? A sturdy concrete bench, lacquered with the same two-component paint in anthracite colour in a playful oval shape. Robustness with a chic finish. The standard anthracite concrete bench is recommended if you like the colour anthracite, but prefer straight shapes. So vary in shape or decoration, but alternating in colour is of course also possible.

3 April 2025 - Prices subject to change

Our products are delivered from our factory in the Netherlands.



correspondence address

HeBlad - UK

The Balance, 7th floor, Pinfold Street
S1 2GU Sheffield, South Yorkshire
T. 0114 352 0110
info@HeBlad.co.uk
www.HeBlad.co.uk

head office address

HeBlad BV

Diamantweg 22
NL - 5527 LC Hapert

Vary the colour with concrete benches

At HeBlad you have a wide choice of benches, game tables and picnic sets. Because most HeBlad products are made of concrete, you can choose from the colours natural concrete, anthracite concrete and anthracite lacquered. Both concrete colours are cast from one piece of concrete so that the colour is retained, even if minor damage occurs.

Contact HeBlad

You can easily order the DeLuxe Anthracite concrete bench with backrest online. Do you have any questions about this concrete bench or about HeBlad's other products? Please contact us, we will be happy to help you.

Our products are delivered from our factory in the Netherlands.

Registered under: HeBlad BV • HM Revenue and Customs • Ruby House 8 • Ruby Place • AB10 1ZP Aberdeen
VAT Number GB381060225 • EORI Number GB381060225000 • Commercial register (NL) 170 66 364
Rabobank De Kempen, Markt 7, 5531 BA Bladel (NL) • BIC RABONL2U • Branch code RABONL2UXXX • IBAN NL 20 RABO 0107530112 GBP

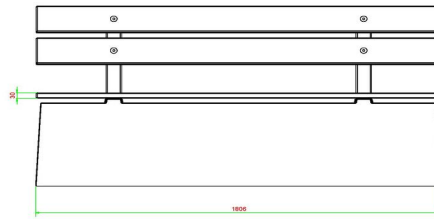
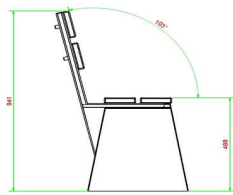
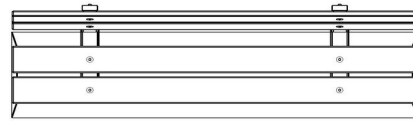
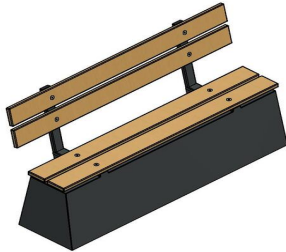

HeBlad
www.HeBlad.com
BB.DLA.ML
gewicht ± 480 KG.

Specifications Concrete bench DeLuxe with backrest Anthracite

Product code	BB.DLA.ML	Material seat	Bamboo
Colour	Anthracite lacquered, RAL 7016	Seating corner	103 degrees
Dimensions (L x W x H)	180 x 45 x 95 cm	Number of seats	4
Seat height	48,5 cm	Weight	630 kg
Dimensions seat	180 x 30 cm		

Related products



BB.DLAB.ML



BB.DL.ML



BB.PB.OP



BB.DL.OV

Our products are delivered from our factory in the Netherlands.



Bench DeLuxe with backrest Anthracite-Concrete

Product code: BB.DLAB.ML

£ 2,050.00 excl. VAT
(£ 2,460.00 incl. VAT)

A concrete bench for the park in your municipality, on the schoolyard or on a walking or cycling route. The benches have become an indispensable part of the street scene. A concrete bench is a perfect spot for a short break during a walk or to meet outside. This encourages people to go outside more often. You can find more information about our products on our website.

Top quality concrete and wood bench

A bench that is ready for passers-by in all weather conditions must be of top quality. The strength of our concrete and wood benches means you can enjoy these items for years to come. The concrete bench has different colour variants. The three colours that HeBlad supplies are Natural Concrete, Anthracite and Anthracite-Concrete.

Concrete base plates for bench

This concrete bench is not supplied with a base plate as standard. If you want to place the bench somewhere on its own, it is important to ensure a sturdy or paved surface. You can also order the base plate online. That would ensure that your bench is stable. An additional advantage of a concrete base plate under a bench is that it is easy to keep the area around the bench clean.

Sustainability

The backrests and seats of our DeLuxe concrete bench are made of high-quality pressed bamboo. Bamboo is a very strong raw material. Bamboo is also very

3 April 2025 - Prices subject to change

Our products are delivered from our factory in the Netherlands.



correspondence address

HeBlad - UK

The Balance, 7th floor, Pinfold Street
S1 2GU Sheffield, South Yorkshire
T. 0114 352 0110
info@HeBlad.co.uk
www.HeBlad.co.uk

head office address

HeBlad BV

Diamantweg 22
NL - 5527 LC Hapert

durable, a major advantage of this material. Bamboo grows quickly and is therefore widely available. It even benefits the plant if you cut bamboo regularly, because it makes it grow faster.

Combine a concrete bench with a ping-pong table

A bench is a welcome addition in a park to a table tennis table or foot volleyball table. Or you could opt for a game table, a bench with a table containing a checkers, chess or ludo game. Do you have any questions about Bench DeLuxe Anthracite-Concrete with backrest or about another product? Please take a look at our frequently asked questions or feel free to contact us, we will be happy to help you.

Our products are delivered from our factory in the Netherlands.

Registered under: HeBlad BV • HM Revenue and Customs • Ruby House 8 • Ruby Place • AB10 1ZP Aberdeen
VAT Number GB381060225 • EORI Number GB381060225000 • Commercial register (NL) 170 66 364
Rabobank De Kempen, Markt 7, 5531 BA Bladel (NL) • BIC RABONL2U • Branch code RABONL2UXXX • IBAN NL 20 RABO 0107530112 GBP

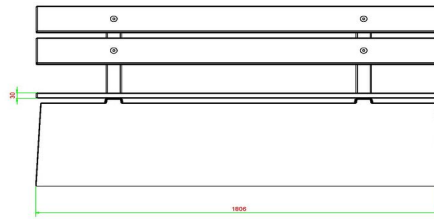
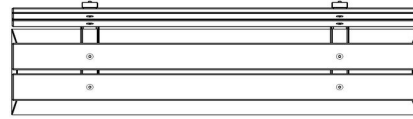
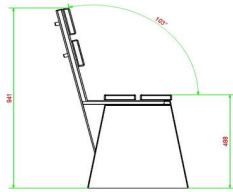
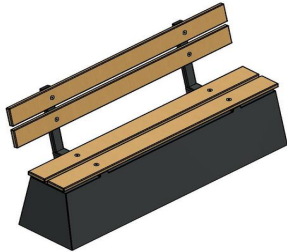

HeBlad
www.HeBlad.com
BB.DLAB.ML
gewicht ± 480 KG.

Specifications Bench DeLuxe with backrest Anthracite-Concrete

Product code	BB.DLAB.ML	Material seat	Bamboo
Colour	Anthracite concrete	Seating corner	103 degrees
Dimensions (L x W x H)	180 x 45 x 95 cm	Number of seats	4
Seat height	48,5 cm	Weight	630 kg
Dimensions seat	180 x 30 cm		

Related products



BB.PB.OP



BB.DLA.ML



BB.PBAB.OP



BB.DL.OV

Our products are delivered from our factory in the Netherlands.



Starter package table tennis bats & balls

Product code: B.DS.SP

£ 72.00 excl. VAT
(£ 86.40 incl. VAT)

A table tennis table is nothing without bats and balls. Every HeBlad ping pong table comes standard with four bats and two balls. Of course you never want to be without these accessories. That is why it is wise to build up a large stock.

The starter package consists of 100 ping pong balls and 10 bats. The balls are white and the bats have the colours red, yellow, blue and green.

What is the delivery time of the starter pack of bats and balls?

When ordering accessories from HeBlad you are assured of fast delivery. We ship immediately the day after the order is received and paid for.

If you ordered the starter package together with a table tennis table from HeBlad, you will receive the package together with the game table and you will also benefit from a nice discount.

Bats and balls and other accessories

We offer various accessories for the table tennis game. You can choose other colours of bats, like pink and blue. Or you can create a large assortment of 10 sets with plastic bats and balls. Are you afraid that the balls will quickly get lost? We also have a solution for that: 100 ping pong balls in one box.

Contact HeBlad

Do you have any questions about HeBlad table tennis table accessories or our other products? Please contact us. We are happy to advise you.

3 April 2025 - Prices subject to change

Our products are delivered from our factory in the Netherlands.

Specifications Starter package table tennis bats & balls

Product code	B.DS.SP
Material	Kunststof

head office address

HeBlad BV
Diamantweg 22
NL - 5527 LC Hapert

Related products



PP.AR.BL



HB.FB.A



B.DS10

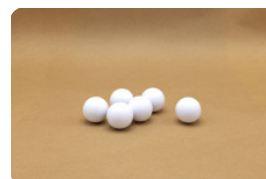

HB.FB.Ball6

Our products are delivered from our factory in the Netherlands.



Plastic all-weather table tennis paddles in 4 colours

Product code: B.S1

£ 15.00 excl. VAT
(£ 18.00 incl. VAT)

To make optimal use of your ping pong table, you need a table tennis bat and ball. At HeBlad you can also order the necessary accessories for your ping pong table. This set consists of 4 table tennis bats in different colours and 2 ping pong balls.

Table tennis bats for outdoor use

The table tennis bats are ideal for outdoor use. They are made of plastic, which makes the bats very sturdy and able to withstand a blow. Very useful if groups of children are going to use this. Because the ping pong bats are made of plastic, they are easy to wash. This is of course pleasant for large-scale use at schools and campsites, for example. The table tennis bats can be cleaned with a simple cleaning agent or dishwashing soap. You don't have to worry about a ping pong bat losing its colour.

Table tennis bats in bright colours

These table tennis bats are available in four different bright colours, namely yellow, green, red and blue. These colours are appealing to children. They pick up the bats and start playing actively quicker. But that's not the only reason. The bright colours make the bats clearly visible and you can easily find them if children leave them in a random place.

Accessories for table tennis table

You can easily order the ping pong bats on our website. In addition to this set of 4 bats with 2 balls, you can also choose a package containing 10 of these sets. Or choose the starter package. A box with no less than 100 ping pong balls and 10 table tennis bats in the colours red, yellow, blue and green. The ping pong balls

3 April 2025 - Prices subject to change

Our products are delivered from our factory in the Netherlands.



correspondence address

HeBlad - UK

The Balance, 7th floor, Pinfold Street
S1 2GU Sheffield, South Yorkshire
T. 0114 352 0110
info@HeBlad.co.uk
www.HeBlad.co.uk

head office address

HeBlad BV

Diamantweg 22
NL - 5527 LC Hapert

are available per 6 or per 100. You will also find the necessary accessories for our other game and play tables: chess pieces, checkers, table football figures and balls: view our page about the various accessories.

Our products are delivered from our factory in the Netherlands.

Registered under: HeBlad BV • HM Revenue and Customs • Ruby House 8 • Ruby Place • AB10 1ZP Aberdeen
VAT Number GB381060225 • EORI Number GB381060225000 • Commercial register (NL) 170 66 364
Rabobank De Kempen, Markt 7, 5531 BA Bladel (NL) • BIC RABONL2U • Branch code RABONL2UXXX • IBAN NL 20 RABO 0107530112 GBP

Specifications Plastic all-weather table tennis paddles in 4 colours

Product code	B.S1
Material	Kunststof

head office address

HeBlad BV
Diamantweg 22
NL - 5527 LC Hapert

Related products



PP.AR.GR



HB.FB.A



B.DS.SP



GT.CH.Pieces



HB.FB.Ball6

Our products are delivered from our factory in the Netherlands.



box with 10 sets of table tennis bats

Product code: B.DS10

£ 125.00 excl. VAT
(£ 150.00 incl. VAT)

Always be sure of playing fun on the table tennis table. With this stock of 10 sets of bats and balls, you can never go wrong. Because the sets are packaged separately, four bats with two balls, these plastic sets are also very easy to resell in, for example, the camping shop. This way you can offer your customers extra playing pleasure during their stay at your campsite.

Accessories from HeBlad

Every HeBlad game table, ping pong table, foot volleyball table or table football table comes with accessories to play the game properly. Each table is supplied with the associated accessories as standard, but these parts can also be ordered separately. This way you ensure that you always have the right materials to play the games. Just like HeBlad's gaming tables, the accessories are also made from raw materials that can be used outdoors without losing their colour or shape. HeBlad stands for reliability and honesty.

What is the delivery time of the plastic bats (10 sets)

When you place your order, we will ship your order immediately the next working day. If you have ordered the accessories from a gaming table, we will deliver everything in one delivery. Because we design, produce and deliver everything in-house, delivery times are short and communication is clear. If you have any questions about HeBlad's delivery conditions, products or accessories, please contact us.

3 April 2025 - Prices subject to change

Our products are delivered from our factory in the Netherlands.

Specifications box with 10 sets of table tennis bats

Product code	B.DS10
Material	Kunststof

head office address

HeBlad BV
Diamantweg 22
NL - 5527 LC Hapert

Related products



PP.R.BL



HB.FB.A

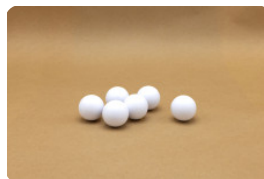

HB.FB.Ball6

Our products are delivered from our factory in the Netherlands.



Table tennis bats Pastel, set of 4

Product code: B.S1.pastel

£ 18.00 excl. VAT
(£ 21.60 incl. VAT)

With the same quality as the regular bats, we now have the version in the pastel colours pink and blue. A gentler approach to the game of table tennis. For example, this set of four bats and two balls fits very well with the low ping pong table from HeBlad, especially for the youngest children. The lower secondary students will be able to identify with the low table and soft colours of the bats. But the choice can of course also be made based on personal taste.

What are table tennis bats and balls made of?

Both the bats and balls are made of plastic. This makes them ideal for outdoor use: they can take a beating and are not sensitive to extreme weather conditions. The plastic is very easy to clean: just use detergent or dishwashing soap and warm water.

How much delivery time is there for the pink and blue table tennis bats? HeBlad's delivery times are short. If you order an accessory, we will ship it immediately the next working day. If you ordered the table tennis bats together with a ping pong table, you will receive the set of bats together with the table.

What is the alternative to the pink and blue table tennis bats

Tastes differ. That is why, in addition to this pastel set of table tennis bats, we also have the more standard colours red, yellow, green and blue. These four colours come in one set with two balls.

You can also purchase this standard set in bulk packaging. The starter pack of bats and balls consists of 100 balls and 10 bats. Or you order 10 sets of plastic bats, where a set consists of 4 bats and 2 balls.

Ask your question to HeBlad

Do you have any questions about our accessories, table tennis tables or other

3 April 2025 - Prices subject to change

Our products are delivered from our factory in the Netherlands.



correspondence address

HeBlad - UK
The Balance, 7th floor, Pinfold Street
S1 2GU Sheffield, South Yorkshire
T. 0114 352 0110
info@HeBlad.co.uk
www.HeBlad.co.uk

head office address

HeBlad BV
Diamantweg 22
NL - 5527 LC Hapert

game tables? Please contact us, we will be happy to advise you.

Our products are delivered from our factory in the Netherlands.

Registered under: HeBlad BV • HM Revenue and Customs • Ruby House 8 • Ruby Place • AB10 1ZP Aberdeen
VAT Number GB381060225 • EORI Number GB381060225000 • Commercial register (NL) 170 66 364
Rabobank De Kempen, Markt 7, 5531 BA Bladel (NL) • BIC RABONL2U • Branch code RABONL2UXXX • IBAN NL 20 RABO 0107530112 GBP

Specifications Table tennis bats Pastel, set of 4

Product code	B.S1.pastel
Material	Kunststof

head office address

HeBlad BV
Diamantweg 22
NL - 5527 LC Hapert

Related products



PP.AR.LOW.GR



PP.AR.LOW.BL



PP.AR.LOW.A



B.S1



B.DS10

Our products are delivered from our factory in the Netherlands.



Bag with 6 ping-pong balls

Product code: B.Z6

£ 8.00 excl. VAT
(£ 9.60 incl. VAT)

HeBlad's ping pong balls are of good quality and in the familiar white colour. Did you know that these ping pong balls are used as practice balls by table tennis clubs? They are that good! Because a ping pong table cannot do without ping pong balls and bats, HeBlad always supplies the ping pong tables with a free set of 4 bats and 2 balls. If you have lost these balls over time, you can also order separate accessories here, such as a set of 6 pieces of ping pong balls.

Order ping pong balls per bag of 6 pieces

You can easily order this set of ping pong balls in a bag of 6 by placing the order online. If you order multiple products you will also receive a discount. If you order the ping pong balls in combination with a ping pong table, both products will be delivered at the same time and you will automatically receive a discount.

Ping pong balls, bats and other accessories

In addition to the ping pong balls in a bag of 6, HeBlad supplies various other accessories associated with a ping pong table. Consider a complete Starter Package of Bats & Balls, consisting of no less than 100 balls and 10 bats. With high-quality plastic and bright colours, the bats are very appealing and with so many ping pong balls the players can play for a long time.

If the starter package is a bit too extensive for the way your ping pong table is used, we also have the option to opt for, for example, a set of 4 plastic table tennis bats. With this set you will receive 4 bats in different colours and 2 ping pong balls.

Big box of ping pong balls

Do you have several table tennis tables? Or would you simply like to have a stock

3 April 2025 - Prices subject to change

Our products are delivered from our factory in the Netherlands.



correspondence address

HeBlad - UK

The Balance, 7th floor, Pinfold Street
S1 2GU Sheffield, South Yorkshire
T. 0114 352 0110
info@HeBlad.co.uk
www.HeBlad.co.uk

head office address

HeBlad BV

Diamantweg 22
NL - 5527 LC Hapert

of table tennis balls? HeBlad has a box of ping pong balls (100 pieces) for heavy users and intensive table tennis players. If you order a box of 100 ping pong balls, you will receive a discount when you expand your order.

Order accessories online or by telephone

All HeBlad accessories can easily be ordered online, but we can also be reached by telephone for orders. Please feel free to contact us to order or to receive additional information about our gaming tables or accessories. We are happy to explain the specifications of a product to you or calculate your discount when placing an order.

Our products are delivered from our factory in the Netherlands.

Registered under: HeBlad BV • HM Revenue and Customs • Ruby House 8 • Ruby Place • AB10 1ZP Aberdeen
VAT Number GB381060225 • EORI Number GB381060225000 • Commercial register (NL) 170 66 364
Rabobank De Kempen, Markt 7, 5531 BA Bladel (NL) • BIC RABONL2U • Branch code RABONL2UXXX • IBAN NL 20 RABO 0107530112 GBP

Specifications Bag with 6 ping-pong balls

Product code	B.Z6
Material	Kunststof

head office address

HeBlad BV
Diamantweg 22
NL - 5527 LC Hapert

Related products



PP.R.GR



HB.FB.A



B.S1

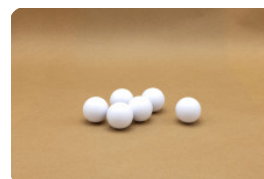

HB.FB.Ball6

Our products are delivered from our factory in the Netherlands.



Box of ping-pong balls packed per 100 pieces

Product code: B.DS100

£ 50.00 excl. VAT
(£ 60.00 incl. VAT)

With a large stock of ping pong balls, you always play the table tennis game with the right attributes. Just like the bats, the balls are made of plastic. This material can be easily cleaned and can be used outdoors.

The quality of the balls is so good that they are used by table tennis clubs as practice balls. But other associations and schools also order large quantities of balls from HeBlad. The delivery time is short, because we ship your order the day after you place the order with us.

There is also a discount for the box of 100 ping pong balls if you purchase multiple products at the same time from HeBlad.

Ping pong balls and table tennis tables

We will provide you with a free set of bats and balls with each table tennis table. And it is always up to you to decide what additional accessories to order. Do you have any questions about the delivery of the products and accessories? Please contact us, we will be happy to tell you more about the conditions and options.

3 April 2025 - Prices subject to change

Our products are delivered from our factory in the Netherlands.

Specifications Box of ping-pong balls packed per 100 pieces

Product code	B.DS100
Material	Kunststof

head office address

HeBlad BV
Diamantweg 22
NL - 5527 LC Hapert

Related products



PP.AR.AB



PP.BL



B.S1



B.DS.SP

Our products are delivered from our factory in the Netherlands.



Picnic set DeLuxe 246cm

Product code: PS.DL.246

£ 3,200.00 excl. VAT
(£ 3,840.00 incl. VAT)

An extra long table with multiple seats. The bamboo seats in this DeLuxe version give the table a luxurious look and offer a softer seat to the visitors of the picnic set. Just like the robust concrete from which the picnic set is made, the bamboo is also weather-resistant and will last for years.

Loose planks for the Picnic Set Deluxe 246 cm.

What to do if a plank breaks or becomes damaged? We understand that bamboo is slightly less sturdy than concrete, which is why you can also order separate planks from us for the DeLuxe picnic set 246 cm. You can easily assemble the shelves yourself, but do not hesitate to contact us for assembly assistance. This can be done remotely or on location.

What are alternatives to the DeLuxe Picnic Set 246 cm?

If you believe that the 246 cm picnic set is too large for the terrain on which you want to place the set, you can always choose a different variant. We also have the DeLuxe Picnic Set in standard sizes. The same beautiful natural concrete colour and also beautiful bamboo seats. This set offers slightly fewer seats, but therefore fits on any playground, campsite or other outdoor area. Is it not big enough for you? Then we advise you to take a look at the Picnic Set Standard XL. This could accommodate an entire football team. The table is 450 cm long, which also applies to the seating area.

Questions about the Picnic Set

Do you have questions about the specifications of HeBlad picnic sets or would you like to combine multiple products and thus benefit from attractive discounts? Please feel free to contact us. We are happy to advise you.

3 April 2025 - Prices subject to change

Our products are delivered from our factory in the Netherlands.

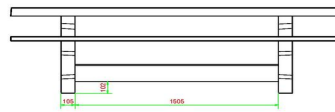
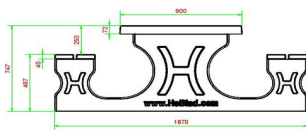
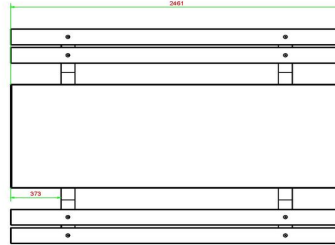
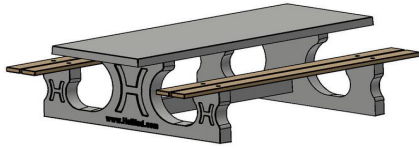

HeBlad
www.HeBlad.com
PS.DL.246
± 875 KG.

Specifications Picnic set DeLuxe 246cm

Product code	PS.DL.246	Seat height	50 cm
Colour	Natural concrete	Material seat	Bamboo
Dimensions (L x W x H)	246 x 193 x 75 cm	Distance legs	161 cm (hart op hart)
Dimensions tabletop (L x W)	246 x 90 cm	Weight	880 kg
Tabletop thickness	7 cm	Number of seats	10
Height tabletop	75 cm		

Related products



PS.DLAB.246



PS.ST.246



OP.PS.246



OP.PS.AB.246

Our products are delivered from our factory in the Netherlands.



Picnic set DeLuxe Anthracite 246cm

Product code: PS.DLA.246

£ 3,300.00 excl. VAT
(£ 3,960.00 incl. VAT)

3 April 2025 - Prices subject to change

Our products are delivered from our factory in the Netherlands.

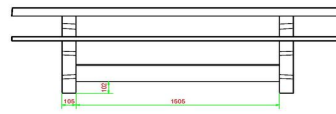
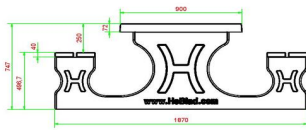
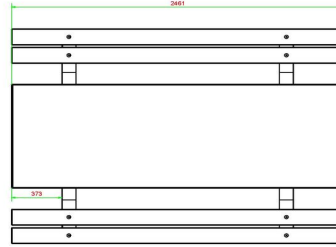
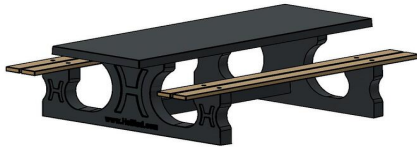

HeBlad
www.HeBlad.com
PS.DLA.246
± 875 KG.

Specifications Picnic set DeLuxe Anthracite 246cm

Product code	PS.DLA.246	Seat height	50 cm
Colour	Anthracite lacquered, RAL 7016	Material seat	Bamboo
Dimensions (L x W x H)	246 x 193 x 75 cm	Distance legs	161 cm (hart op hart)
Dimensions tabletop (L x W)	246 x 90 cm	Weight	880 kg
Tabletop thickness	7 cm	Number of seats	10

Height tabletop 75 cm

Related products



PS.STA.246



PS.DLA



HB.Paint-7016



OP.PS.246



OP.PS.AB.246

Our products are delivered from our factory in the Netherlands.



Picnic set DeLuxe Anthracite-Concrete 246cm

Product code: PS.DLAB.246

£ 3,350.00 excl. VAT
(£ 4,020.00 incl. VAT)

3 April 2025 - Prices subject to change

Our products are delivered from our factory in the Netherlands.

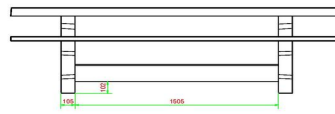
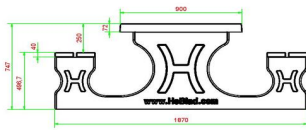
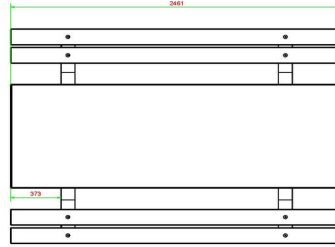
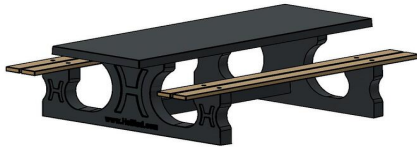

HeBlad
www.HeBlad.com
PS.DLAB.246
± 875 KG.

Specifications Picnic set DeLuxe Anthracite-Concrete 246cm

Product code	PS.DLAB.246	Seat height	50 cm
Colour	Anthracite concrete	Material seat	Bamboo
Dimensions (L x W x H)	246 x 193 x 75 cm	Distance legs	161 cm (hart op hart)
Dimensions tabletop (L x W)	246 x 90 cm	Weight	880 kg
Tabletop thickness	7 cm	Number of seats	10

Related products 75 cm



PS.DL.AB



PS.STAB.246



PS.DLA.246



PS.DL.246



PS.DLAB.OV

Our products are delivered from our factory in the Netherlands.



Bottom plate Picnic table Natural Concrete

Product code: OP.PS

£ 1,725.00 excl. VAT
(£ 2,070.00 incl. VAT)

A base plate is used to keep the immediate surroundings of a picnic set tidy. It prevents weeds or grass from growing under the picnic set. The space around the base plate is easy to maintain, because the base plate is placed at cutting height. The base plate is also ideal for placing the picnic set stably on an uneven surface or on softer grounds.

What is the base plate made of?

Like all other Heblad products, the base plates are made of concrete. They have an anti-slip profile in the form of a criss-cross pattern. This finish ensures that neither the visitors or players or the table can slip on the base plate.

Delivery and installation of the base plate

If you ensure that the sand bed is prepared at the correct height, we will deliver the base plate and place it in the right location. In order to actually deliver the base plate to the right place, it is important that we can park our truck no more than five meters away. The base plate is placed in the right place from the truck with the crane. If you have any questions about installation and delivery, please read the terms and conditions of delivery or contact us. Please note that the base plate is always optional, it is never included in the price of a picnic set.

Which models of picnic sets fit on the base plate?

In principle, all Heblad picnic set models fit on the base plate measuring 248 x 236 x 7 cm, both the standard picnic sets and the oval picnic sets, as well as the

3 April 2025 - Prices subject to change

Our products are delivered from our factory in the Netherlands.



correspondence address

HeBlad - UK
The Balance, 7th floor, Pinfold Street
S1 2GU Sheffield, South Yorkshire
T. 0114 352 0110
info@HeBlad.co.uk
www.HeBlad.co.uk

head office address

HeBlad BV
Diamantweg 22
NL - 5527 LC Hapert

wheelchair-accessible sets. The XL picnic sets require two base plates.

Base plate for ping pong tables

Base plates can also be ordered for our game tables and ping-pong tables. Here too, plates must be ordered additionally, they do not automatically come with the product. If you want to be sure of the correct base plate or perhaps you are unsure whether a base plate is necessary, please contact us. We are happy to advise you.

Our products are delivered from our factory in the Netherlands.

Registered under: HeBlad BV • HM Revenue and Customs • Ruby House 8 • Ruby Place • AB10 1ZP Aberdeen
VAT Number GB381060225 • EORI Number GB381060225000 • Commercial register (NL) 170 66 364
Rabobank De Kempen, Markt 7, 5531 BA Bladel (NL) • BIC RABONL2U • Branch code RABONL2UXXX • IBAN NL 20 RABO 0107530112 GBP

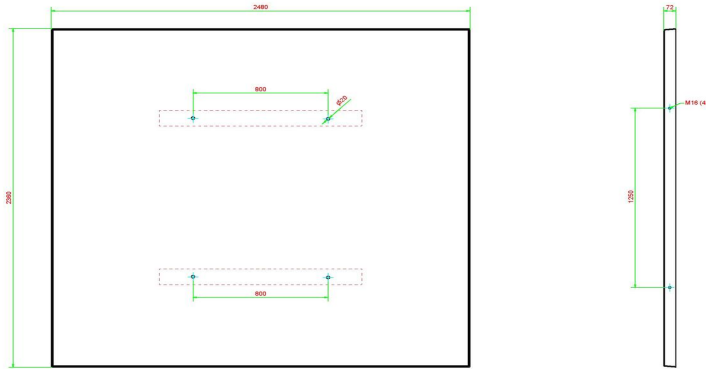

HeBlad
www.HeBlad.com
OP.PS
Gewicht ± 1000 KG.

Specifications Bottom plate Picnic table Natural Concrete

Product code	OP.PS	Weight	1000 kg
Colour	Natural concrete	lifting device	Concrete screw sleeve M16 on 4 sides
Dimensions (L x W x H)	248 x 236 x 7 cm	preparation attachment	Holes for bolts M16
Finishing base plate	Anti-slip (window) profile		

Related products



PS.DL



PS.ST



PS.DL.OV



OP.PS.AB



PS.ST.OV

Our products are delivered from our factory in the Netherlands.



Bottom plate Picnic table Anthracite-Concrete

Product code: OP.PS.AB

£ 1,825.00 excl. VAT
(£ 2,190.00 incl. VAT)

What is the added value of a base plate? It can be an aesthetic choice to place a base plate under the standard anthracite concrete picnic set. Simply because you find that more attractive than having the picnic set 'loose' in the space. It is also common that the surface on which the picnic set is placed is too soft to bear the weight of the set or that the surface is not even. A base plate is the ideal solution against unwanted growth of moss, grass or weeds under the table and seats.

Specifications concrete base plate anthracite concrete

What does the concrete base plate from HeBlad weigh? The weight of the anthracite concrete base plate for the picnic set is 1000 kg. The base plate distributes the weight of the picnic set (905 kg) over the entire surface of the plate. The dimensions of the plate are 248 x 236 x 7 cm. The entire plate is provided with an anti-slip diamond profile and has pre-drilled holes for M16 bolts with which the picnic set is secured to the plate.

Variants of the concrete base plate

The base plate for the standard picnic sets is also available in the colour natural concrete. This plate has the same specifications and dimensions, but in the neutral concrete colour. Specifically for the picnic sets with a length of 246 cm, we make the base plate anthracite concrete 246, it has a dimension of 245 x 300 x 10 cm and weighs 1700 kg. These large base plates can also be ordered in the colours natural concrete and anthracite concrete.

Base plate picnic set or table tennis table

Base plates are also available for HeBlad table tennis tables. The base plate ping-pong table anthracite concrete and the base plate ping-pong table natural

3 April 2025 - Prices subject to change

Our products are delivered from our factory in the Netherlands.



correspondence address

HeBlad - UK

The Balance, 7th floor, Pinfold Street
S1 2GU Sheffield, South Yorkshire
T. 0114 352 0110
info@HeBlad.co.uk
www.HeBlad.co.uk

head office address

HeBlad BV

Diamantweg 22
NL - 5527 LC Hapert

concrete have a dimension of 299 x 179 x 10 cm, a weight of 1270 kg and are made of smooth concrete. The holes for the attachment of the ping-pong table have already been pre-drilled in exactly the right places.

Delivery of base plate

Due to the size and weight of the base plates, it is important that we can come within five meters of the installation location with our delivery truck. We always ask for the ground to be prepared in advance, i.e. to dig it out in the right place at the right depth. We can then use our crane to perfectly place the base plate directly from the truck. Please contact us if there are any doubts or questions.

Our products are delivered from our factory in the Netherlands.

Registered under: HeBlad BV • HM Revenue and Customs • Ruby House 8 • Ruby Place • AB10 1ZP Aberdeen
VAT Number GB381060225 • EORI Number GB381060225000 • Commercial register (NL) 170 66 364
Rabobank De Kempen, Markt 7, 5531 BA Bladel (NL) • BIC RABONL2U • Branch code RABONL2UXXX • IBAN NL 20 RABO 0107530112 GBP

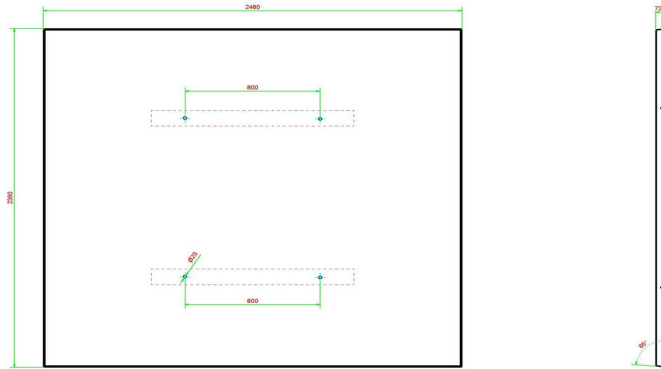

HeBlad
www.HeBlad.com
OP.PS.AB
Gewicht ± 1000 KG.

Specifications Bottom plate Picnic table Anthracite-Concrete

Product code	OP.PS.AB	Weight	1000 kg
Colour	Anthracite concrete	lifting device	Concrete screw sleeve M16 on 4 sides
Dimensions (L x W x H)	248 x 236 x 7 cm	preparation attachment	Holes for bolts M16
Finishing base plate	Anti-slip (window) profile		

Related products



PS.DL.A



PS.ST.A



PS.DLAB.OV



OP.PS



PS.STAB.OV

Our products are delivered from our factory in the Netherlands.



Bench DeLuxe with bottom plate without backrest **Natural Concrete**

Product code: BB.DL.OP.ZL

We see the concrete bench everywhere these days. In the park, on a cycle route, on a playground, in the forest or on a schoolyard. A concrete bench is a perfect place to take a break, enjoy company outside and enjoy nature. On this website you can find more information about this concrete bench, its variants and matching products.

Quality of the concrete bench

Because the HeBlad concrete bench, like the other concrete products, is made of very strong concrete, the concrete bench is solid and strong and destruction is hardly possible. Because of the concrete base plate that forms a whole with this concrete bench, you will have much less trouble with dirt, grass or mud under your bench. And rubbish is easier to sweep away and clean up than on a grass or forest surface, for example.

Different variants of the concrete bench

The concrete bench is available in different colours. This set is in the colour Natural Concrete. The other colours are: Anthracite and Anthracite-Concrete. This variant in Natural Concrete has a base plate and no backrest. Of course we also have benches with backrests in our range. As well as picnic sets and benches with a curve.

Sustainable bench

This concrete bench is our DeLuxe bench. The seat is made of high-quality

£ 2,025.00 excl. VAT
(£ 2,430.00 incl. VAT)

3 April 2025 - Prices subject to change

Our products are delivered from our factory in the Netherlands.



correspondence address

HeBlad - UK

The Balance, 7th floor, Pinfold Street
S1 2GU Sheffield, South Yorkshire
T. 0114 352 0110
info@HeBlad.co.uk
www.HeBlad.co.uk

head office address

HeBlad BV

Diamantweg 22
NL - 5527 LC Hapert

pressed bamboo. Bamboo is a type of wood that grows very quickly and is sustainable and very durable. The material is also quite tough. Ideal for our benches.

Combining the concrete bench

HeBlad products can be combined well with one another. For example, you can place the concrete bench near a table tennis table or a foot volleyball table. This way, turn the park in your municipality, the sports park or playground into an inviting place. A place to meet, be active and enjoy the healthy outdoors.

Questions

Do you have any questions about the DeLuxe concrete bench with base plate without backrest or about another product? Please take a look at our frequently asked questions or feel free to contact us, we are happy to help you.

These benches with a fixed base plate will be located at ground level. When the sand bed is ready at height, we can place the bench in the right place with the crane, provided this is within 5 meters of our truck.

Our products are delivered from our factory in the Netherlands.

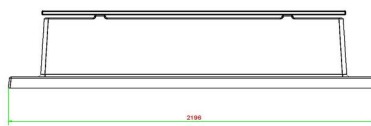
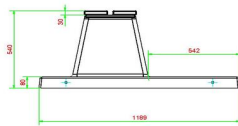
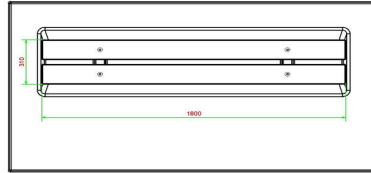
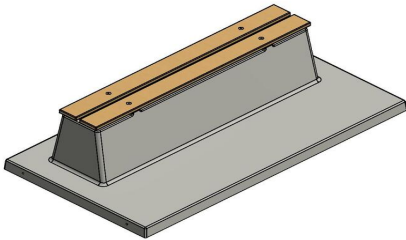

HeBlad
www.HeBlad.com
BB.DL.OP.ZL
gewicht ± 1200 KG.

Specifications Bench DeLuxe with bottom plate without backrest Natural Concrete

Product code	BB.DL.OP.ZL	Material seat	Bamboo
Colour	Natural concrete	Number of seats	4
Dimensions (L x W x H)	219,5 x 119 x 56,5 cm	Dimensions base plate (L x W x H)	1800 x 119 x 8 cm
Seat height	45 cm	Finishing base plate	Smooth concrete
Dimensions seat	180 x 30 cm	Weight	1200 kg

Related products



BB.ST.A



PS.DL.RT



PP.AR.GR



HB.FB.A



BB.PB.OP

Our products are delivered from our factory in the Netherlands.



Concrete bench DeLuxe with bottom plate without backrest Anthracite

Product code: BB.DLA.OP.ZL

You are looking for a multifunctional addition to your garden, grounds or park. This concrete bench DeLuxe anthracite with base plate without backrest is the ideal addition. With its shiny anthracite colour and beautiful bamboo seating, you have seats and a safe separation in one. Because this park bench has no backrest, the concrete bench looks elegant and is at the same time extremely sturdy. Because the bench is painted anthracite, it is almost impossible to tell that the park bench is made of concrete.

Concrete bench combines sitting and safety

The entire park bench including base plate is cast from one piece of concrete. This ensures that the bench can always be placed firmly and stably. It also gives weeds no chance to settle around the bench, so the concrete bench always keeps its neat appearance. The seat height of 45 cm is comfortable and the lack of a backrest allows various seating positions to be adopted.

In addition to comfortable seating, this chic concrete park bench can also be used to divide a site and even as protection against ram raids. The concrete strength makes it impossible to knock over the bank and makes the bank impervious to vandalism.

Combine the concrete bench with picnic sets

Just like the concrete park benches, our picnic sets are also made of concrete. So if you have room for a beautiful standard anthracite picnic set, it would be a great addition to the concrete bench. This picnic set has the same anthracite colour

£ 2,075.00 excl. VAT
(£ 2,490.00 incl. VAT)

3 April 2025 - Prices subject to change

Our products are delivered from our factory in the Netherlands.



correspondence address

HeBlad - UK

The Balance, 7th floor, Pinfold Street
S1 2GU Sheffield, South Yorkshire
T. 0114 352 0110
info@HeBlad.co.uk
www.HeBlad.co.uk

head office address

HeBlad BV

Diamantweg 22
NL - 5527 LC Hapert

which means it combines perfectly with the anthracite-lacquered concrete bench. If you prefer a more natural look, the concrete bench is also available in DeLuxe anthracite concrete bench. This park bench has a comparable colour, but instead of being lacquered, it is made of fully coloured concrete. This park bench fits perfectly with the standard anthracite concrete picnic set. Of course it is up to you to decide. All benches, picnic sets, table tennis tables and game tables can be ordered in many variants. We have a product for everyone.

Contact HeBlad

Because the range at HeBlad is so large, we are happy to help you choose. Contact us and we will think along with you.

These benches with a fixed base plate will be located at ground level. When the sand bed is ready at height, we can place the bench in the right place with the crane, provided this is within 5 meters of our truck. Please always consult the terms and conditions of delivery.

Our products are delivered from our factory in the Netherlands.

Registered under: HeBlad BV • HM Revenue and Customs • Ruby House 8 • Ruby Place • AB10 1ZP Aberdeen
VAT Number GB381060225 • EORI Number GB381060225000 • Commercial register (NL) 170 66 364
Rabobank De Kempen, Markt 7, 5531 BA Bladel (NL) • BIC RABONL2U • Branch code RABONL2UXXX • IBAN NL 20 RABO 0107530112 GBP

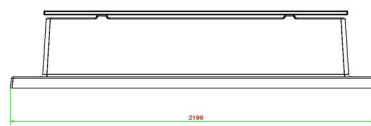
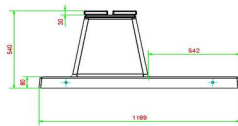
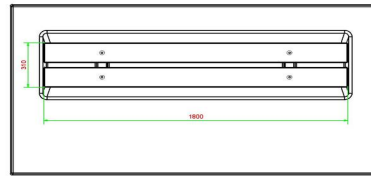
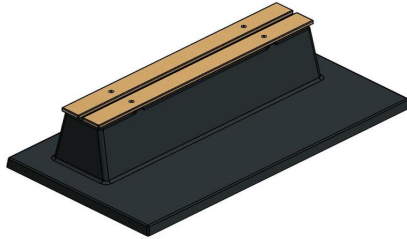

HeBlad
www.HeBlad.com
BB.DLA.OP.ZL
gewicht ± 1200 KG.

Specifications Concrete bench DeLuxe with bottom plate without backrest Anthracite

Product code	BB.DLA.OP.ZL	Material seat	Bamboo
Colour	Anthracite lacquered, RAL 7016	Number of seats	4
Dimensions (L x W x H)	219,5 x 119 x 56,5 cm	Dimensions base plate (L x W x H)	2195 x 119 x 8 cm
Seat height	45 cm	Finishing base plate	Smooth concrete
Dimensions seat	180 x 30 cm	Weight	1200 kg

Related products



BB.DLA.OV



PS.DLA.RT



PP.AR.BL



HB.FB.A

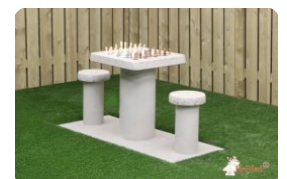

GT.CH.G2

Our products are delivered from our factory in the Netherlands.



Bench DeLuxe with bottom plate without backrest Anthracite-Concrete

Product code: BB.DLAB.OP.ZL

A solid concrete bench with a comfortable seat. The base plate and the bench are made from one piece of concrete. Robust, strong, beautiful and practical. As a finishing touch, the seat is covered with bamboo elements. Both the concrete and the bamboo are resistant to extreme influences of weather or vandalism.

£ 2,100.00 excl. VAT
(£ 2,520.00 incl. VAT)

Where is the DeLuxe concrete bench placed?

Due to its strength and weight, the DeLuxe Anthracite Concrete Bench can undoubtedly be placed in public spaces and generally accessible places. The weight and base plate ensure that the bench cannot be pushed or blown over. The base plate is also located at cutting height in the lawn or at the same height as terrain tiles or sand. This means that the area around the concrete bench is always neat and free of weeds, grass and moss.

How is the DeLuxe concrete bench installed?

As can be read in our delivery conditions, we deliver our products via the loading and unloading crane on the truck, which is approximately 14 meters long. The crane reaches a maximum of 5 meters. This means that the installation area must be accessible to our truck with crane, within a radius of 5 meters.

Variation on the DeLuxe concrete bench

This concrete bench DeLuxe is available in three colours: Natural Concrete, Anthracite-Concrete and Anthracite. Variations on the bench include the Concrete Bench DeLuxe Anthracite-Concrete with Base Plate and Backrest or the Bench

3 April 2025 - Prices subject to change

Our products are delivered from our factory in the Netherlands.



correspondence address

HeBlad - UK

The Balance, 7th floor, Pinfold Street
S1 2GU Sheffield, South Yorkshire
T. 0114 352 0110
info@HeBlad.co.uk
www.HeBlad.co.uk

head office address

HeBlad BV

Diamantweg 22
NL - 5527 LC Hapert

DeLuxe Anthracite-Concrete, without base plate. These products are also available in three colours. Not convinced yet? See which other benches we offer.

Concrete bench DeLuxe in-house production

All HeBlad products and accessories are made in our own production hall in Hapert, the Netherlands. That is why it is feasible for us to deliver quickly, provide clear production and delivery times and keep you informed of the progress of your order.

Our team of experts is always ready to advise you, provide explanations or help you determine the options for your site. We cordially invite you to contact us.

Our products are delivered from our factory in the Netherlands.

Registered under: HeBlad BV • HM Revenue and Customs • Ruby House 8 • Ruby Place • AB10 1ZP Aberdeen
VAT Number GB381060225 • EORI Number GB381060225000 • Commercial register (NL) 170 66 364
Rabobank De Kempen, Markt 7, 5531 BA Bladel (NL) • BIC RABONL2U • Branch code RABONL2UXXX • IBAN NL 20 RABO 0107530112 GBP

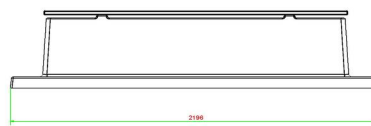
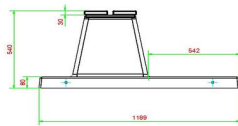
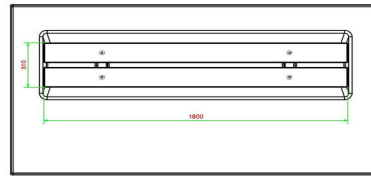
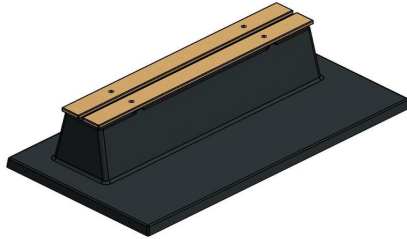

HeBlad
www.HeBlad.com
BB.DLAB.OP.ZL
gewicht ± 1200 KG.

Specifications Bench DeLuxe with bottom plate without backrest Anthracite-Concrete

Product code	BB.DLAB.OP.ZL	Material seat	Bamboo
Colour	Anthracite concrete	Number of seats	4
Dimensions (L x W x H)	219,5 x 119 x 56,5 cm	Dimensions base plate (L x W x H)	1199 x 119 x 8 cm
Seat height	45 cm	Finishing base plate	Smooth concrete
Dimensions seat	180 x 30 cm	Weight	1200 kg

Related products



BB.DL.OP.ZL



BB.DLAB.ML



BB.PB.OP

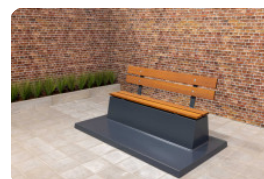

BB.DLA.OP



BB.DL.OV

Our products are delivered from our factory in the Netherlands.



Picnic table Standard XL Natural Concrete

Product code: PS.ST.XL

£ 5,050.00 excl. VAT
(£ 6,060.00 incl. VAT)

Cast from one piece of natural concrete, this picnic set XL is a beautiful and practical eye-catcher for your site. It offers room for a complete football team and is indestructible. Years of seating pleasure for many visitors!

What are the specifications of the standard XL picnic set?

The weight of this picnic set is no less than 2100 kg. The set has the ideal ratio between tabletop and seats and the total dimensions are 450 x 192 x 75 cm. Robustness and solidity do not come at the expense of the beautiful appearance of this picnic set. It is a true jewel for the location.

Alternatives to the standard XL picnic set

If you are looking for seating for larger groups, the XL version of the picnic set is recommended. In addition to this natural concrete colour, you can also choose from anthracite concrete and anthracite lacquered. Do you prefer compact, do you lack space to place an XL picnic set or do you prefer several smaller picnic sets instead of one large one? HeBlad's offering is extensive. In the same colours as the picnic set XL, you can choose from standard, oval and DeLuxe. DeLuxe stands for a finish with bamboo seats. More comfortable seating, but with the same weather resistance as concrete!

Base plate and concrete benches

It may sometimes be wise to use a base plate to place the picnic set standard XL or other HeBlad products. This base plate provides strength and stability and can

3 April 2025 - Prices subject to change

Our products are delivered from our factory in the Netherlands.



correspondence address

HeBlad - UK

The Balance, 7th floor, Pinfold Street
S1 2GU Sheffield, South Yorkshire
T. 0114 352 0110
info@HeBlad.co.uk
www.HeBlad.co.uk

head office address

HeBlad BV

Diamantweg 22
NL - 5527 LC Hapert

be ordered separately from the set, it is not included in the price. Concrete benches from HeBlad can be used to supplement the picnic set. Not only beautiful and practical, but can also be used as extra protection of your site.

Contact HeBlad

We understand that our wide range can be overwhelming and that you may have questions about our products and the options at your location. Therefore, please contact us and ask your questions to one of our employees. We work with professionals who are happy to think along with you.

Our products are delivered from our factory in the Netherlands.

Registered under: HeBlad BV • HM Revenue and Customs • Ruby House 8 • Ruby Place • AB10 1ZP Aberdeen
VAT Number GB381060225 • EORI Number GB381060225000 • Commercial register (NL) 170 66 364
Rabobank De Kempen, Markt 7, 5531 BA Bladel (NL) • BIC RABONL2U • Branch code RABONL2UXXX • IBAN NL 20 RABO 0107530112 GBP

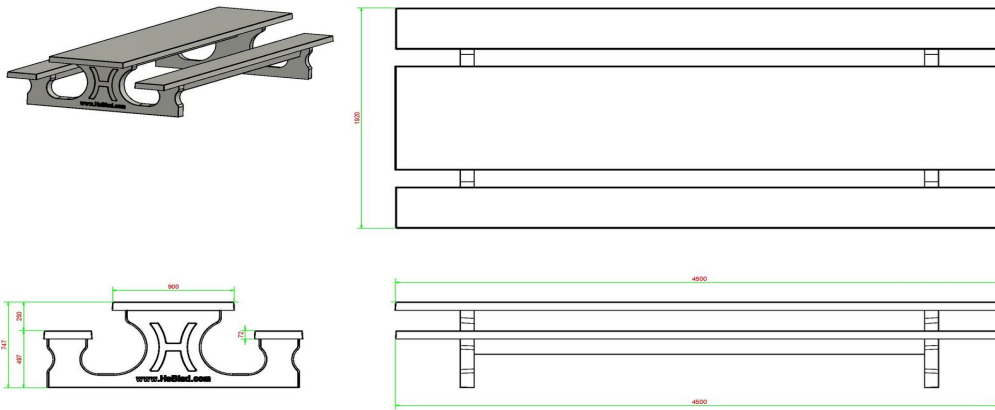

HeBlad
www.HeBlad.com
PS.ST.XL
± 2100 KG.

Specifications Picnic table Standard XL Natural Concrete

Product code	PS.ST.XL	Tabletop thickness	7 cm
Colour	Natural concrete	Seat height	50 cm
Dimensions (L x W x H)	450 x 192 x 75 cm	Weight	2100 kg
Dimensions tabletop (L x W)	450 x 90 cm	Material seat	Beton
Height tabletop	75 cm	Distance legs	355 cm (hart op hart)

Related products



PS.STAB.XL



PS.STA.XL



PS.DL.RT



OP.PS



PS.ST

Our products are delivered from our factory in the Netherlands.



Concrete Picnic table Standard XL Anthracite

Product code: PS.STA.XL

£ 5,300.00 excl. VAT
(£ 6,360.00 incl. VAT)

This standard picnic set in the XL version has the warm colour anthracite, painted with RAL 7016. The dimensions of the total picnic set are 450 x 192 x 75 cm with a tabletop of 450 x 90 cm. The seat height is 50 cm, which makes the ratio between the seating area and the tabletop ideal. How is the 2100 kg picnic set delivered? It is clear that it is not easy to transport and install a completely concrete product with these dimensions and this weight. That is why we take care of this ourselves with the help of experienced employees. While we often work with a crane for other HeBlad products, the XL picnic set can only be unloaded directly next to our truck, after which it can be rolled further if necessary. This therefore places demands on the space where the set will be placed. Read the delivery conditions carefully in advance or contact us.

Base plate for the picnic set XL Anthracite

Delivery and installation of the picnic set XL is done with care and precision on a flat surface. Due to the weight of the picnic set, the surface on which the table will be placed is essential. Is a base plate required for the picnic set XL? Depending on the density, strength and stability of the surface, a base plate may be advisable. This base plate is specifically designed for the large XL picnic set and can be ordered separately. If you have any doubts about the suitability of your site, we advise you to contact us.

Where can XL picnic sets be located?

XL means extra large. An entire football team fits on this table, so naturally sports clubs use this picnic set. But schoolyards are also decorated with this practical

3 April 2025 - Prices subject to change

Our products are delivered from our factory in the Netherlands.



correspondence address

HeBlad - UK

The Balance, 7th floor, Pinfold Street
S1 2GU Sheffield, South Yorkshire
T. 0114 352 0110
info@HeBlad.co.uk
www.HeBlad.co.uk

head office address

HeBlad BV

Diamantweg 22
NL - 5527 LC Hapert

set. And what about large parks where families come together? Don't have the space for this XL version? No problem, HeBlad picnic sets are also available in regular sizes, such as the standard anthracite picnic set. The same beautiful sleek anthracite colour, but slightly more compact. The base plate is always optional and not included in the price of the picnic set.

Our products are delivered from our factory in the Netherlands.

Registered under: HeBlad BV • HM Revenue and Customs • Ruby House 8 • Ruby Place • AB10 1ZP Aberdeen
VAT Number GB381060225 • EORI Number GB381060225000 • Commercial register (NL) 170 66 364
Rabobank De Kempen, Markt 7, 5531 BA Bladel (NL) • BIC RABONL2U • Branch code RABONL2UXXX • IBAN NL 20 RABO 0107530112 GBP

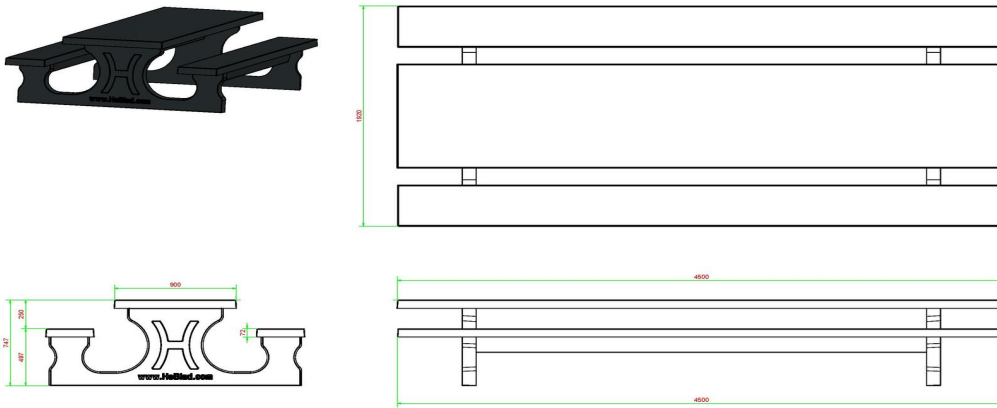

HeBlad
www.HeBlad.com
PS.STA.XL
± 2100 KG.

Specifications Concrete Picnic table Standard XL Anthracite

Product code	PS.STA.XL	Tabletop thickness	7 cm
Colour	Anthracite lacquered, RAL 7016	Seat height	50 cm
Dimensions (L x W x H)	450 x 192 x 75 cm	Weight	2100 kg
Dimensions tabletop (L x W)	450 x 90 cm	Material seat	Beton
Height tabletop	75 cm	Distance legs	355 (hart op hart)

Related products



PS.ST



BB.DL.ML



HB.FB.A



PP.BL



OP.PS.AB

Our products are delivered from our factory in the Netherlands.



Picnic table Standard XL Anthracite-Concrete

Product code: PS.STAB.XL

£ 5,300.00 excl. VAT
(£ 6,360.00 incl. VAT)

This very large concrete picnic table can accommodate 18-20 people. The ideal concrete table for large groups of people in public areas.

Concrete Picnic Set XL

This concrete picnic set XL is an ideal table for large groups of people in public spaces. This picnic set can accommodate 18-20 people. On this page you will find more information about this picnic set XL.

Quality of the picnic set XL

Because this picnic set XL is made of high-quality concrete, like all products that HeBlad offers, this picnic set XL is very sturdy and destruction is hardly possible. This way you can enjoy your picnic set for years to come.

Optional base plates

You can also order your picnic set XL with base plates. The bottom plates ensure that you are not bothered by grass or mud under your bench. This means that the possibility of slipping is minimal. Furthermore, the maintenance of a picnic set with a base plate is a lot easier.

Different variants of concrete picnic sets

This picnic set is made of coloured concrete. This means that the anthracite concrete colour is not created by painting, but by the concrete, which is even

3 April 2025 - Prices subject to change

Our products are delivered from our factory in the Netherlands.

coloured anthracite on the inside. This method ensures that the colour of this set remains beautiful over the years. This picnic set XL is also available in anthracite colour and natural concrete colour.

Combining the picnic set XL

All HeBlad products are easy to combine with each other. This way you create a beautiful, cozy and atmospheric place where people can come together for a chat, a moment of rest or just a little more action. You can combine this picnic set XL with a table tennis table or a foot volleyball table for an active gaming environment. Another option is to add some game tables to the picnic set with a game tray for a game of checkers, ludo or chess. The different combinations ensure that both young and old can have fun outside.

Interested in the XL picnic set?

Are you interested in this Picnic set XL from HeBlad? Order quickly, easily and safely on our website. Do you have any questions about the HeBlad picnic set XL or another product? Please view our frequently asked questions page or contact us. We are happy to help you.

* The bottom plates are optional

Our products are delivered from our factory in the Netherlands.

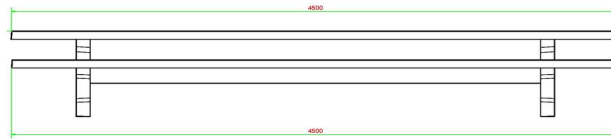
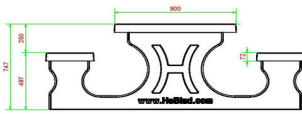
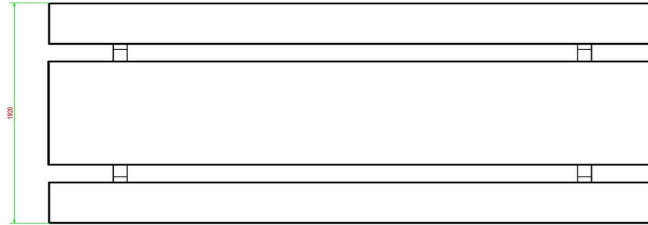
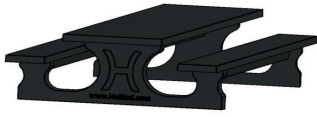

HeBlad
www.HeBlad.com
PS.STAB.XL
± 2100 KG.

Specifications Picnic table Standard XL Anthracite-Concrete

Product code	PS.STAB.XL	Tabletop thickness	7 cm
Colour	Anthracite concrete	Seat height	50 cm
Dimensions (L x W x H)	450 x 192 x 75 cm	Weight	2100 kg
Dimensions tabletop (L x W)	450 x 90 cm	Material seat	Beton
Height tabletop	75 cm	Distance legs	355 (hart op hart)

Related products



PS.ST.XL



PS.STA.XL



PS.DLAB.RT



OP.PS.AB



PS.ST.AB

Our products are delivered from our factory in the Netherlands.



Bench DeLuxe with bottom plate and backrest Naural Concrete

£ 2,175.00 excl. VAT
(£ 2,610.00 incl. VAT)

Product code: BB.DL.OP

The most chic and extensive version of all HeBlad benches: Concrete Bench DeLuxe with base plate and backrest. The concrete bench and base plate are cast from one piece of natural concrete, making the bench incredibly sturdy, impossible to tip over and resistant to vandalism. This concrete bench owes the title DeLuxe to the bamboo seat and backrest. Both the concrete and bamboo are weather-resistant and made to last outdoors for years.

Why a base plate for the concrete bench?

In addition to a high degree of stability, a base plate also has the great advantage that the seating area always looks neat. No unwanted growth of grasses, moss or weeds under the bench. The base plate is placed in the grass at cutting height, so mowing the lawn around the plate is easy and you won't have to worry about edge cutting. Always have a well-maintained seating space.

How much space is needed around the concrete bench?

For this DeLuxe concrete bench with base plate and backrest, you must take into account a surface of 220 x 120 cm. It is also important for the delivery of the concrete bench that we can get within five meters of the installation location with our truck and crane. For additional information, please contact us or view the delivery conditions.

Tips for concrete benches

HeBlad's range of concrete benches is large, but which concrete bench is best to

3 April 2025 - Prices subject to change

Our products are delivered from our factory in the Netherlands.



correspondence address

HeBlad - UK

The Balance, 7th floor, Pinfold Street
S1 2GU Sheffield, South Yorkshire
T. 0114 352 0110
info@HeBlad.co.uk
www.HeBlad.co.uk

head office address

HeBlad BV

Diamantweg 22
NL - 5527 LC Hapert

buy? The first consideration will be made based on your taste. Do you like natural or anthracite? Do you prefer angular shapes or do you prefer round ones? In addition, the environment plays a role in determining the choice of colour, design and shape. The surface will also be a factor in your decision as to whether a base plate is desirable or not. The base plates can also be ordered separately from HeBlad.

Contact HeBlad

For all your questions about the concrete benches, their delivery or other HeBlad products, you are welcome to contact us. We'd love to hear from you.

Our products are delivered from our factory in the Netherlands.

Registered under: HeBlad BV • HM Revenue and Customs • Ruby House 8 • Ruby Place • AB10 1ZP Aberdeen
VAT Number GB381060225 • EORI Number GB381060225000 • Commercial register (NL) 170 66 364
Rabobank De Kempen, Markt 7, 5531 BA Bladel (NL) • BIC RABONL2U • Branch code RABONL2UXXX • IBAN NL 20 RABO 0107530112 GBP

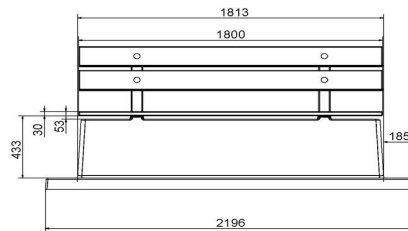
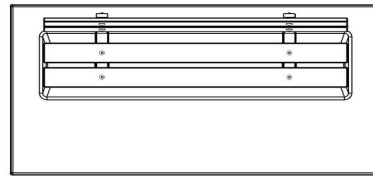
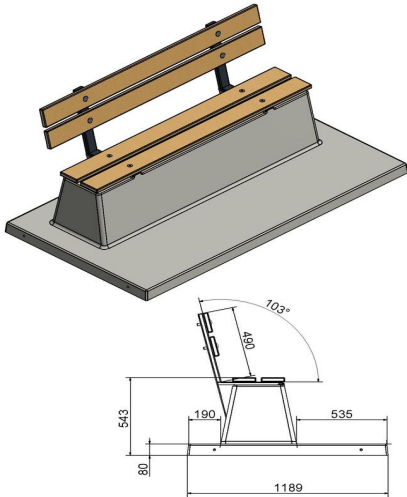

HeBlad
www.HeBlad.com
BB.DL.OP

gewicht ± 1200 KG.

Specifications Bench DeLuxe with bottom plate and backrest Naural Concrete

Product code	BB.DL.OP	Seating corner	103 degrees
Colour	Natural concrete	Number of seats	4
Dimensions (L x W x H)	219,5 x 119 x 103 cm	Dimensions base plate (L x W x H)	1189 x 119 x 8 cm
Seat height	45 cm	Finishing base plate	Smooth concrete
Dimensions seat	180 x 30 cm	Weight	1230 kg

Related products Bamboo



BB.DLA.OP



BB.DLAB.OP.ZL



BB.PBAB.OP



BB.DL.OV

Our products are delivered from our factory in the Netherlands.



Concrete bench DeLuxe with bottom plate and backrest Anthracite

Product code: BB.DLA.OP

This DeLuxe Anthracite concrete bench with base plate and handrail is made of concrete and bamboo. Both materials are durable and weather-resistant and can be left outside for years. A nice addition to any terrain.

Practical but beautiful

Why the Concrete Bench DeLuxe Anthracite? Just like HeBlad's other concrete benches, this bench is also specifically designed and produced for outdoor living. The difference with the versions in anthracite concrete and natural concrete is the lacquer layer that additionally protects this product against weather influences and gives the bench a beautiful, sleek appearance. The RAL 7016 colour is an extra protective layer and makes cleaning the bench easy.

Delivery and installation of the Concrete Bench DeLuxe

How is the DeLuxe concrete bench installed? The bench can be placed in areas with sufficient space and where our truck with crane has access within five meters of the installation location. Always read the delivery conditions first. If you have any questions after reading, please do not hesitate to contact us. We can calculate exactly what space and passage is needed to install it.

Contact HeBlad

Would you like more information about the DeLuxe concrete bench or other HeBlad products? We have a team of experts ready to assist you, so do not hesitate to contact us. Because we do everything in-house, from design and

£ 2,225.00 excl. VAT
(£ 2,670.00 incl. VAT)

3 April 2025 - Prices subject to change

Our products are delivered from our factory in the Netherlands.



correspondence address

HeBlad - UK

The Balance, 7th floor, Pinfold Street
S1 2GU Sheffield, South Yorkshire
T. 0114 352 0110
info@HeBlad.co.uk
www.HeBlad.co.uk

head office address

HeBlad BV

Diamantweg 22
NL - 5527 LC Hapert

production to delivery and installation, we know everything about the possibilities for your site. You are also assured of fast delivery, clear communication and personal involvement.

Our products are delivered from our factory in the Netherlands.

Registered under: HeBlad BV • HM Revenue and Customs • Ruby House 8 • Ruby Place • AB10 1ZP Aberdeen
VAT Number GB381060225 • EORI Number GB381060225000 • Commercial register (NL) 170 66 364
Rabobank De Kempen, Markt 7, 5531 BA Bladel (NL) • BIC RABONL2U • Branch code RABONL2UXXX • IBAN NL 20 RABO 0107530112 GBP

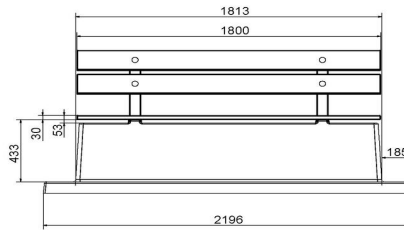
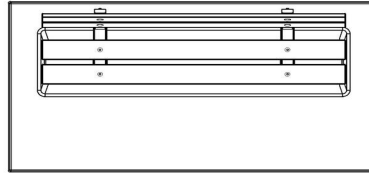
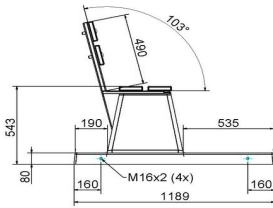
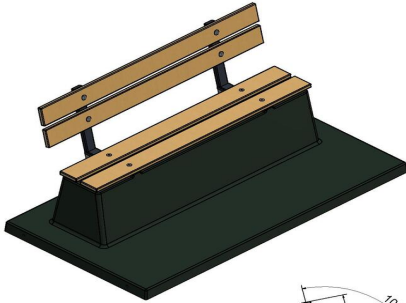

HeBlad
www.HeBlad.com
BB.DLA.OP

gewicht ± 1200 KG.

Specifications Concrete bench DeLuxe with bottom plate and backrest Anthracite

Product code	BB.DLA.OP	Seating corner	103 degrees
Colour	Anthracite lacquered, RAL 7016	Number of seats	4
Dimensions (L x W x H)	219,5 x 119 x 103 cm	Dimensions base plate (L x W x H)	1189 x 119 x 8 cm
Seat height	45 cm	Finishing base plate	Smooth concrete
Dimensions seat	180 x 30 cm	Weight	1230 kg

Related products



BB.DLAB.OP



BB.DL.OP



BB.PB.OP



BB.DL.OV

Our products are delivered from our factory in the Netherlands.



Bench DeLuxe with bottom plate and backrest Anthracite-Concrete

Product code: BB.DLAB.OP

Comfortable, beautiful and long lasting. The concrete bench DeLuxe Anthracite concrete with base plate and backrest is made from one piece of coloured concrete. The base plate and the bench consist of one piece and cannot be separated. Ideal to prevent vandalism. The seat and backrest are firmly mounted on the concrete. Just like the concrete, the bamboo is resistant to all weather influences and looks chic and attractive.

The base plate offers strength and convenience

The base plate of this Bench DeLuxe will be located at ground level. This makes mowing the lawn around the bench very easy. No unwanted growth of grass or moss under the bench.

How much does the DeLuxe bench with base plate and backrest weigh? With a full weight of no less than 1230 kg, it makes sense that this bench is impossible to move without the right equipment.

How is the concrete bench placed?

With such weight, it is important to consult the delivery conditions. Installing this concrete bench requires expertise, which is why we deliver the benches ourselves. The bench is placed in the right place from the truck using a crane. The place where the bench will be placed can not be further away than five meters from the truck. We always recommend that you contact us first to avoid disappointments.

Combine HeBlad products

£ 2,250.00 excl. VAT
(£ 2,700.00 incl. VAT)

3 April 2025 - Prices subject to change

Our products are delivered from our factory in the Netherlands.



correspondence address

HeBlad - UK

The Balance, 7th floor, Pinfold Street
S1 2GU Sheffield, South Yorkshire
T. 0114 352 0110
info@HeBlad.co.uk
www.HeBlad.co.uk

head office address

HeBlad BV

Diamantweg 22
NL - 5527 LC Hapert

Because all HeBlad products are produced in the same place, our own factory in Hapert, the Netherlands, combinations of products are easy to arrange. You are also assured of fast delivery times and clear communication. When you order multiple products from HeBlad, you will also receive an attractive discount on the second or subsequent item. So feel free to place a beautiful picnic set or game table next to the concrete bench.

Our products are delivered from our factory in the Netherlands.

Registered under: HeBlad BV • HM Revenue and Customs • Ruby House 8 • Ruby Place • AB10 1ZP Aberdeen
VAT Number GB381060225 • EORI Number GB381060225000 • Commercial register (NL) 170 66 364
Rabobank De Kempen, Markt 7, 5531 BA Bladel (NL) • BIC RABONL2U • Branch code RABONL2UXXX • IBAN NL 20 RABO 0107530112 GBP

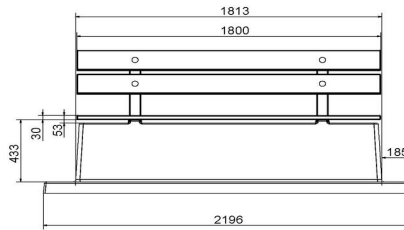
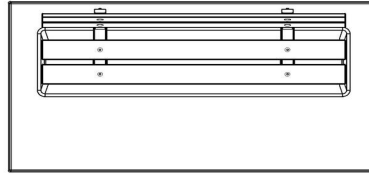
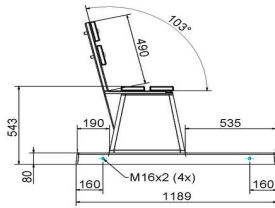
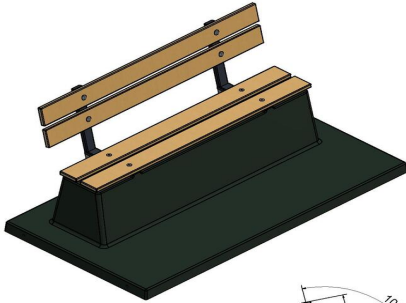

HeBlad
www.HeBlad.com
BB.DLAB.OP
gewicht ± 1200 KG.

Specifications Bench DeLuxe with bottom plate and backrest Anthracite-Concrete

Product code	BB.DLAB.OP	Seating corner	103 degrees
Colour	Anthracite concrete	Number of seats	4
Dimensions (L x W x H)	219,5 x 119 x 103 cm	Dimensions base plate (L x W x H)	2195 x 119 x 8 cm
Seat height	45 cm	Finishing base plate	Smooth concrete
Dimensions seat	180 x 30 cm	Weight	1230 kg

Related products



BB.DLA.OP



BB.PB.OP



BB.PBAB.OP

Our products are delivered from our factory in the Netherlands.



Bottom plate Picnic table Natural Concrete

Product code: OP.PS

£ 1,725.00 excl. VAT
(£ 2,070.00 incl. VAT)

A base plate is used to keep the immediate surroundings of a picnic set tidy. It prevents weeds or grass from growing under the picnic set. The space around the base plate is easy to maintain, because the base plate is placed at cutting height. The base plate is also ideal for placing the picnic set stably on an uneven surface or on softer grounds.

What is the base plate made of?

Like all other HeBlad products, the base plates are made of concrete. They have an anti-slip profile in the form of a criss-cross pattern. This finish ensures that neither the visitors or players or the table can slip on the base plate.

Delivery and installation of the base plate

If you ensure that the sand bed is prepared at the correct height, we will deliver the base plate and place it in the right location. In order to actually deliver the base plate to the right place, it is important that we can park our truck no more than five meters away. The base plate is placed in the right place from the truck with the crane. If you have any questions about installation and delivery, please read the terms and conditions of delivery or contact us. Please note that the base plate is always optional, it is never included in the price of a picnic set.

Which models of picnic sets fit on the base plate?

In principle, all HeBlad picnic set models fit on the base plate measuring 248 x 236 x 7 cm, both the standard picnic sets and the oval picnic sets, as well as the

3 April 2025 - Prices subject to change

Our products are delivered from our factory in the Netherlands.



correspondence address

HeBlad - UK

The Balance, 7th floor, Pinfold Street
S1 2GU Sheffield, South Yorkshire
T. 0114 352 0110
info@HeBlad.co.uk
www.HeBlad.co.uk

head office address

HeBlad BV

Diamantweg 22
NL - 5527 LC Hapert

wheelchair-accessible sets. The XL picnic sets require two base plates.

Base plate for ping pong tables

Base plates can also be ordered for our game tables and ping-pong tables. Here too, plates must be ordered additionally, they do not automatically come with the product. If you want to be sure of the correct base plate or perhaps you are unsure whether a base plate is necessary, please contact us. We are happy to advise you.

Our products are delivered from our factory in the Netherlands.

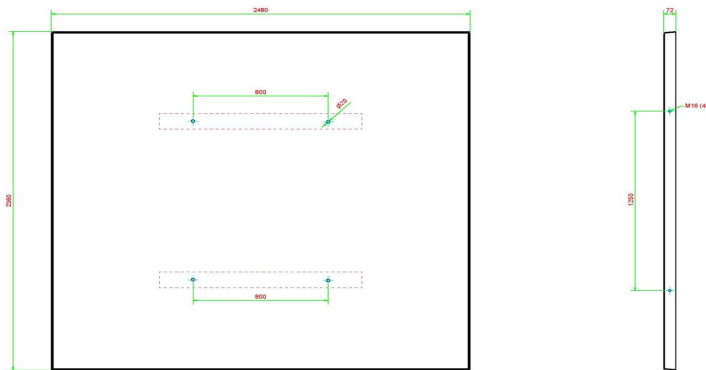

HeBlad
www.HeBlad.com
OP.PS
Gewicht ± 1000 KG.

Specifications Bottom plate Picnic table Natural Concrete

Product code	OP.PS	Weight	1000 kg
Colour	Natural concrete	lifting device	Concrete screw sleeve M16 on 4 sides
Dimensions (L x W x H)	248 x 236 x 7 cm	preparation attachment	Holes for bolts M16
Finishing base plate	Anti-slip (window) profile		

Related products



PS.DL



PS.ST



PS.DL.OV



OP.PS.AB



PS.ST.OV

Our products are delivered from our factory in the Netherlands.



Bottom plate Picnic table Anthracite-Concrete

Product code: OP.PS.AB

£ 1,825.00 excl. VAT
(£ 2,190.00 incl. VAT)

What is the added value of a base plate? It can be an aesthetic choice to place a base plate under the standard anthracite concrete picnic set. Simply because you find that more attractive than having the picnic set 'loose' in the space. It is also common that the surface on which the picnic set is placed is too soft to bear the weight of the set or that the surface is not even. A base plate is the ideal solution against unwanted growth of moss, grass or weeds under the table and seats.

Specifications concrete base plate anthracite concrete

What does the concrete base plate from HeBlad weigh? The weight of the anthracite concrete base plate for the picnic set is 1000 kg. The base plate distributes the weight of the picnic set (905 kg) over the entire surface of the plate. The dimensions of the plate are 248 x 236 x 7 cm. The entire plate is provided with an anti-slip diamond profile and has pre-drilled holes for M16 bolts with which the picnic set is secured to the plate.

Variants of the concrete base plate

The base plate for the standard picnic sets is also available in the colour natural concrete. This plate has the same specifications and dimensions, but in the neutral concrete colour. Specifically for the picnic sets with a length of 246 cm, we make the base plate anthracite concrete 246, it has a dimension of 245 x 300 x 10 cm and weighs 1700 kg. These large base plates can also be ordered in the colours natural concrete and anthracite concrete.

Base plate picnic set or table tennis table

Base plates are also available for HeBlad table tennis tables. The base plate ping-pong table anthracite concrete and the base plate ping-pong table natural

3 April 2025 - Prices subject to change

Our products are delivered from our factory in the Netherlands.



correspondence address

HeBlad - UK

The Balance, 7th floor, Pinfold Street
S1 2GU Sheffield, South Yorkshire
T. 0114 352 0110
info@HeBlad.co.uk
www.HeBlad.co.uk

head office address

HeBlad BV

Diamantweg 22
NL - 5527 LC Hapert

concrete have a dimension of 299 x 179 x 10 cm, a weight of 1270 kg and are made of smooth concrete. The holes for the attachment of the ping-pong table have already been pre-drilled in exactly the right places.

Delivery of base plate

Due to the size and weight of the base plates, it is important that we can come within five meters of the installation location with our delivery truck. We always ask for the ground to be prepared in advance, i.e. to dig it out in the right place at the right depth. We can then use our crane to perfectly place the base plate directly from the truck. Please contact us if there are any doubts or questions.

Our products are delivered from our factory in the Netherlands.

Registered under: HeBlad BV • HM Revenue and Customs • Ruby House 8 • Ruby Place • AB10 1ZP Aberdeen
VAT Number GB381060225 • EORI Number GB381060225000 • Commercial register (NL) 170 66 364
Rabobank De Kempen, Markt 7, 5531 BA Bladel (NL) • BIC RABONL2U • Branch code RABONL2UXXX • IBAN NL 20 RABO 0107530112 GBP

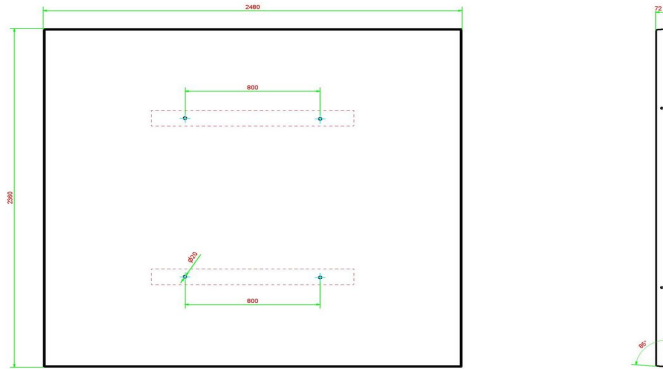

HeBlad
www.HeBlad.com
OP.PS.AB
Gewicht ± 1000 KG.

Specifications Bottom plate Picnic table Anthracite-Concrete

Product code	OP.PS.AB	Weight	1000 kg
Colour	Anthracite concrete	lifting device	Concrete screw sleeve M16 on 4 sides
Dimensions (L x W x H)	248 x 236 x 7 cm	preparation attachment	Holes for bolts M16
Finishing base plate	Anti-slip (window) profile		

Related products



PS.DL.A



PS.ST.A



PS.DLAB.OV



OP.PS



PS.STAB.OV

Our products are delivered from our factory in the Netherlands.



Bottom plate Picnic set 246cm

Product code: OP.PS.AB.246

£ 2,100.00 excl. VAT
(£ 2,520.00 incl. VAT)

3 April 2025 - Prices subject to change

Our products are delivered from our factory in the Netherlands.

Specifications Bottom plate Picnic set 246cm

Product code	OP.PS.AB.246	Weight	1700 kg
Colour	Anthracite concrete	lifting device	Concrete lifting device
Dimensions (L x W x H)	245 x 300 x 10 cm	preparation attachment	Holes for bolts M16
Finishing base plate	Smooth concrete		

head office address

HeBlad BV
Diamantweg 22
5527 EC Hapert
Concrete Street 11

Related products



OP.PS.246



PS.DL.246



PS.ST.246



PS.DLAB.246



PS.STA.246

Our products are delivered from our factory in the Netherlands.



Bottom plate Picnic set 246cm

Product code: OP.PS.AB.246

£ 2,100.00 excl. VAT
(£ 2,520.00 incl. VAT)

3 April 2025 - Prices subject to change

Our products are delivered from our factory in the Netherlands.

Specifications Bottom plate Picnic set 246cm

Product code	OP.PS.AB.246	Weight	1700 kg
Colour	Anthracite concrete	lifting device	Concrete lifting device
Dimensions (L x W x H)	245 x 300 x 10 cm	preparation attachment	Holes for bolts M16
Finishing base plate	Smooth concrete		

head office address

HeBlad BV
Diamantweg 22
5527 EC Hapert
Concrete Street 11

Related products



OP.PS.246



PS.DL.246



PS.ST.246



PS.DLAB.246



PS.STA.246

Our products are delivered from our factory in the Netherlands.



Universal Base plate for Benches

Product code: OP.BB

£ 1,600.00 excl. VAT
(£ 1,920.00 incl. VAT)

The base plate of 248 x 120 cm is specifically designed to be placed under HeBlad's concrete benches and table football table. These HeBlad products have exactly the right weight to prevent them from sliding on the diamond profile of this base plate.

The base plate is not only suitable for HeBlad products. For example, you can also place this base plate under your own park bench. It is most likely a good idea to anchor the bench in the base plate. For an additional charge, we can even include cutouts in the base plate, so that your bench fits exactly on the base plate. For this we ask you to contact us in advance.

What makes the base plate so special?

In addition to the stability that the base plate guarantees, the ground diamond profile ensures that the plate does not become slippery when exposed to water or moisture. Placing a base plate under your bench protects you from weeds and unwanted growth of grass or moss near the bench. Any grass around the base plate can be mowed easily and neatly, because the plate can easily be placed in the ground at cutting height.

Concrete bench base plate specifications

What are the dimensions of the base plate? With a size of 246 x 120 x 10 cm and a weight of 525 kg, the base plate is quite a solid product. For this reason, the sheet is loaded directly onto the truck from production in our factory in Hapert, the Netherlands, using a loading and unloading crane. It is important to check the delivery conditions in advance, because the truck with crane cannot just arrive on location anywhere.

3 April 2025 - Prices subject to change

Our products are delivered from our factory in the Netherlands.



correspondence address

HeBlad - UK

The Balance, 7th floor, Pinfold Street
S1 2GU Sheffield, South Yorkshire
T. 0114 352 0110
info@HeBlad.co.uk
www.HeBlad.co.uk

head office address

HeBlad BV

Diamantweg 22
NL - 5527 LC Hapert

Bottom plates from HeBlad

All HeBlad products are made with the same strength and cast from one piece of concrete. This may mean that a bottom plate is desirable for stability. Placing a base plate also prevents the ground from collapsing under the game table.

We have designed a special base plate for every HeBlad product. Think of base plates for the ping pong table or a picnic set. In most cases the base plate is optional, you order it separately from the product to be installed. In some cases we have integrated the base plate into the design. This is where the bottom plate is attached. Take the concrete park bench or DeLuxe concrete bench.

Our products are delivered from our factory in the Netherlands.

Registered under: HeBlad BV • HM Revenue and Customs • Ruby House 8 • Ruby Place • AB10 1ZP Aberdeen
VAT Number GB381060225 • EORI Number GB381060225000 • Commercial register (NL) 170 66 364
Rabobank De Kempen, Markt 7, 5531 BA Bladel (NL) • BIC RABONL2U • Branch code RABONL2UXXX • IBAN NL 20 RABO 0107530112 GBP

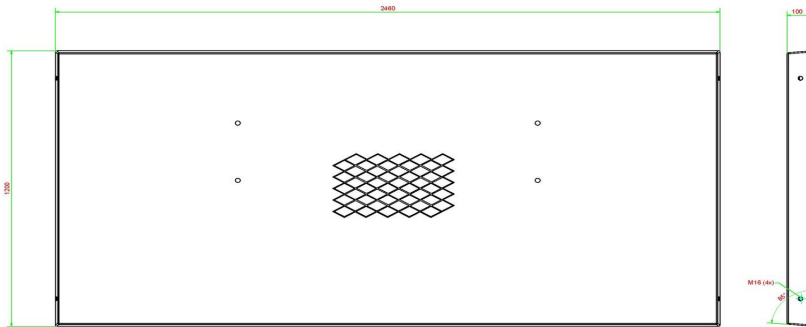

HeBlad
www.HeBlad.com
OP.BB
Gewicht ± 700

Specifications Universal Base plate for Benches

Product code	OP.BB	Weight	525 kg
Colour	Naturel beton	Finishing base plate	Anti-slip (window) profile
Dimensions (L x W x H)	248 x 120 x 7 cm	lifting device	Concrete screw sleeve M16 on 4 sides

Related products



BB.DL.A



BB.DL.OV

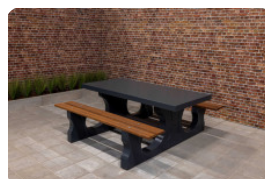

PS.DL.A



HB.FB.A



PP.AR.GR

Our products are delivered from our factory in the Netherlands.



Universa, Base plate for Benches, anthracite-concrete

Product code: OP.BB.AB

£ 1,650.00 excl. VAT
(£ 1,980.00 incl. VAT)

Why a base plate? A base plate provides strength and stability to the bench or football table that is placed on it. Thanks to the diamond profile on the top, slipperiness is prevented in damp weather. Liquid drains into the gutters and the concrete prevents unwanted growth of weeds and the like around the bench. This base plate with dimensions of 246 x 120 x 10 cm is specially made for supporting a HeBlad concrete bench. Because this plate is made of thoroughly coloured anthracite concrete, it fits perfectly with the anthracite oval concrete bench or DeLuxe anthracite concrete bench.

How is the base plate placed?

Due to the weight of 525 kg and the large dimensions, this base plate is delivered with a truck with loading and unloading crane. The reach of the crane is five meters, which means that the installation must be done within five meters of the truck. So always advise our delivery conditions in advance.

The base plate can be placed at cutting height. This makes it easy to keep the area around the plaque tidy. You can mow the lawn without having to cut and sweep without annoying edges.

Which base plate fits best?

At HeBlad we love customization and suitable solutions. That is why we have developed various base plates that match our gaming tables exactly. The base plates for our ping pong tables and picnic sets are also available separately. You can also choose from the colour natural concrete or anthracite concrete. Completely tailored to the product that will be placed on the base plate.

3 April 2025 - Prices subject to change

Our products are delivered from our factory in the Netherlands.



correspondence address

HeBlad - UK

The Balance, 7th floor, Pinfold Street
S1 2GU Sheffield, South Yorkshire
T. 0114 352 0110
info@HeBlad.co.uk
www.HeBlad.co.uk

head office address

HeBlad BV

Diamantweg 22
NL - 5527 LC Hapert

Contact about the anthracite-concrete bench base plate

Do you have any questions about the base plate for the anthracite-concrete bench? Could you use advice on whether or not to install a base plate? Or would you like to know more about HeBlad's other products? Please contact us, we will be happy to help you.

Our products are delivered from our factory in the Netherlands.

Registered under: HeBlad BV • HM Revenue and Customs • Ruby House 8 • Ruby Place • AB10 1ZP Aberdeen
VAT Number GB381060225 • EORI Number GB381060225000 • Commercial register (NL) 170 66 364
Rabobank De Kempen, Markt 7, 5531 BA Bladel (NL) • BIC RABONL2U • Branch code RABONL2UXXX • IBAN NL 20 RABO 0107530112 GBP

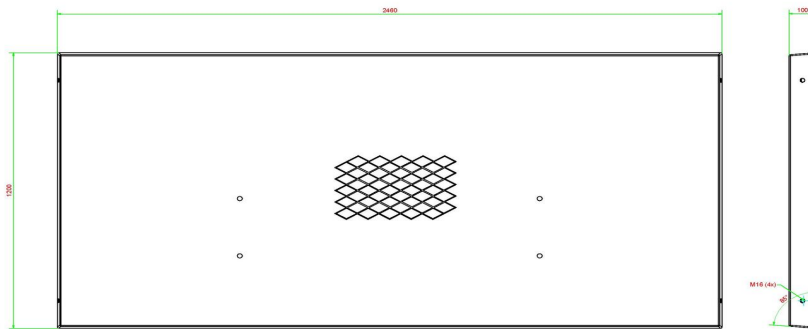

HeBlad
www.HeBlad.com
OP.BB.AB
Gewicht ± 700

Specifications Universa, Base plate for Benches, anthracite-concrete

Product code	OP.BB.AB	Weight	525 kg
Colour	Anthracite concrete	Finishing base plate	Anti-slip (window) profile
Dimensions (L x W x H)	248 x 120 x 7,2 cm	lifting device	Concrete screw sleeve M16 on 4 sides

Related products



OP.BB



OP.PS.AB



BB.ST.A



BB.DLA.ML



BB.DLA.OV

Our products are delivered from our factory in the Netherlands.



Bamboo planks

Product code: PS.Plank

£ 60.00 excl. VAT
(£ 72.00 incl. VAT)

The name DeLuxe stands for bamboo in HeBlad's concrete benches. Bamboo seating and, in some cases, also a bamboo backrest. Bamboo is durable, weather-resistant and strong. Unfortunately, bamboo is less resistant to vandalism than concrete. The bamboo planks can be damaged by, for example, being cut into. The weather also has more influence on bamboo than on concrete. Therefore, the concrete bench or picnic set may still be in excellent condition, but the bamboo parts need to be replaced. If this is ever the case, you won't need to purchase an entirely new bench.

Straight bamboo planks for renewal

By replacing the bamboo plank or planks that are damaged or weathered, you will have a completely new-looking bench or seating area. Choose the sustainable and less expensive solution. Can the bamboo planks also be placed on other benches? You can also use this straight bamboo plank to replace planks on benches that do not come from HeBlad. In this case it's good to keep in mind that the shelves are designed for HeBlad products and that the mounting holes are pre-drilled at a distance of 111 cm center to center.

Delivery of the straight bamboo plank

When will the straight bamboo plank be delivered? The plank will be sent to you immediately after placing your order. This allows you to quickly install a new plank if you notice damage or weathering. Use an Allen key to assemble the bamboo plank. You can order this Allen key separately from HeBlad, if you do not have one yourself.

Contact HeBlad

3 April 2025 - Prices subject to change

Our products are delivered from our factory in the Netherlands.



correspondence address

HeBlad - UK

The Balance, 7th floor, Pinfold Street
S1 2GU Sheffield, South Yorkshire
T. 0114 352 0110
info@HeBlad.co.uk
www.HeBlad.co.uk

head office address

HeBlad BV

Diamantweg 22
NL - 5527 LC Hapert

You may have questions about dismantling and assembling the bamboo plank or the accessories needed to replace the bamboo plank. Please feel free to contact us, we will be happy to help you.

Our products are delivered from our factory in the Netherlands.

Registered under: HeBlad BV • HM Revenue and Customs • Ruby House 8 • Ruby Place • AB10 1ZP Aberdeen
VAT Number GB381060225 • EORI Number GB381060225000 • Commercial register (NL) 170 66 364
Rabobank De Kempen, Markt 7, 5531 BA Bladel (NL) • BIC RABONL2U • Branch code RABONL2UXXX • IBAN NL 20 RABO 0107530112 GBP

Specifications Bamboo planks

Product code	PS.Plank
Material	FSC bamboo
Dimensions (L x W x H)	180 x 14 x 3 cm
Weight	12.6 kg

head office address

HeBlad BV
Diamantweg 22
NL - 5527 LC Hapert

Related products



BB.DL.A



PS.Plank.OV



BB.DL.OP



PS.DLA.OV



PS.DL

Our products are delivered from our factory in the Netherlands.



Set of oval bamboo planks

Product code: PS.Plank.OV

£ 170.00 excl. VAT
(£ 204.00 incl. VAT)

The DeLuxe benches and picnic sets oval from HeBlad are equipped with bamboo seats. Wonderfully soft to the buttocks and very chic to the eye. Bamboo is a material that is specifically used to last a long time outdoors in all weather conditions. Despite the strength of the material, bamboo is slightly more sensitive than concrete to extreme weather influences, damage and vandalism. That is why you can order the oval planks for the DeLuxe picnic set separately from us. This way you will have a new, sturdy picnic set in no time.

Where are HeBlad's picnic sets located?

You can find HeBlad products everywhere in Europe, sometimes even beyond. Our products are often found at campsites, such as the well-known table tennis tables. We regularly install football tables or foot volleyball tables at sports clubs. Our other gaming tables are also immensely popular with a large audience. Because the tables are supplied complete with associated accessories, several players can always participate at the same time and the tables are also very popular in parks or in a home or business situation.

How to order the set of oval planks or other products

Our website makes it very simple and clear to place an order immediately. When you order multiple products at the same time, you will automatically receive a nice discount on the second and subsequent products. If you have any questions about your order, the space you have available, delivery times or about HeBlad itself, please contact us. We would like to take you into the world of robust gaming tables.

3 April 2025 - Prices subject to change

Our products are delivered from our factory in the Netherlands.

Specifications Set of oval bamboo planks

Product code	PS.Plank.OV
Dimensions (L x W x H)	185 x 79 x 3 cm
Material	FSC bamboo
Weight	2 x 12 kg

head office address

HeBlad BV
Diamantweg 22
NL - 5527 LC Hapert

Related products



PS.Plank



BB.DL.OV



BB.DLA.OV



BB.STA.OV

Our products are delivered from our factory in the Netherlands.



Bamboo planks

Product code: PS.Plank

£ 60.00 excl. VAT
(£ 72.00 incl. VAT)

The name DeLuxe stands for bamboo in HeBlad's concrete benches. Bamboo seating and, in some cases, also a bamboo backrest. Bamboo is durable, weather-resistant and strong. Unfortunately, bamboo is less resistant to vandalism than concrete. The bamboo planks can be damaged by, for example, being cut into. The weather also has more influence on bamboo than on concrete. Therefore, the concrete bench or picnic set may still be in excellent condition, but the bamboo parts need to be replaced. If this is ever the case, you won't need to purchase an entirely new bench.

Straight bamboo planks for renewal

By replacing the bamboo plank or planks that are damaged or weathered, you will have a completely new-looking bench or seating area. Choose the sustainable and less expensive solution. Can the bamboo planks also be placed on other benches? You can also use this straight bamboo plank to replace planks on benches that do not come from HeBlad. In this case it's good to keep in mind that the shelves are designed for HeBlad products and that the mounting holes are pre-drilled at a distance of 111 cm center to center.

Delivery of the straight bamboo plank

When will the straight bamboo plank be delivered? The plank will be sent to you immediately after placing your order. This allows you to quickly install a new plank if you notice damage or weathering. Use an Allen key to assemble the bamboo plank. You can order this Allen key separately from HeBlad, if you do not have one yourself.

Contact HeBlad

3 April 2025 - Prices subject to change

Our products are delivered from our factory in the Netherlands.



correspondence address

HeBlad - UK

The Balance, 7th floor, Pinfold Street
S1 2GU Sheffield, South Yorkshire
T. 0114 352 0110
info@HeBlad.co.uk
www.HeBlad.co.uk

head office address

HeBlad BV

Diamantweg 22
NL - 5527 LC Hapert

You may have questions about dismantling and assembling the bamboo plank or the accessories needed to replace the bamboo plank. Please feel free to contact us, we will be happy to help you.

Our products are delivered from our factory in the Netherlands.

Registered under: HeBlad BV • HM Revenue and Customs • Ruby House 8 • Ruby Place • AB10 1ZP Aberdeen
VAT Number GB381060225 • EORI Number GB381060225000 • Commercial register (NL) 170 66 364
Rabobank De Kempen, Markt 7, 5531 BA Bladel (NL) • BIC RABONL2U • Branch code RABONL2UXXX • IBAN NL 20 RABO 0107530112 GBP

Specifications Bamboo planks

Product code	PS.Plank
Material	FSC bamboo
Dimensions (L x W x H)	180 x 14 x 3 cm
Weight	12.6 kg

head office address

HeBlad BV
Diamantweg 22
NL - 5527 LC Hapert

Related products



BB.DL.A



PS.Plank.OV



BB.DL.OP



PS.DLA.OV



PS.DL

Our products are delivered from our factory in the Netherlands.



Set of oval bamboo planks

Product code: PS.Plank.OV

£ 170.00 excl. VAT
(£ 204.00 incl. VAT)

The DeLuxe benches and picnic sets oval from HeBlad are equipped with bamboo seats. Wonderfully soft to the buttocks and very chic to the eye. Bamboo is a material that is specifically used to last a long time outdoors in all weather conditions. Despite the strength of the material, bamboo is slightly more sensitive than concrete to extreme weather influences, damage and vandalism. That is why you can order the oval planks for the DeLuxe picnic set separately from us. This way you will have a new, sturdy picnic set in no time.

Where are HeBlad's picnic sets located?

You can find HeBlad products everywhere in Europe, sometimes even beyond. Our products are often found at campsites, such as the well-known table tennis tables. We regularly install football tables or foot volleyball tables at sports clubs. Our other gaming tables are also immensely popular with a large audience. Because the tables are supplied complete with associated accessories, several players can always participate at the same time and the tables are also very popular in parks or in a home or business situation.

How to order the set of oval planks or other products

Our website makes it very simple and clear to place an order immediately. When you order multiple products at the same time, you will automatically receive a nice discount on the second and subsequent products. If you have any questions about your order, the space you have available, delivery times or about HeBlad itself, please contact us. We would like to take you into the world of robust gaming tables.

3 April 2025 - Prices subject to change

Our products are delivered from our factory in the Netherlands.

Specifications Set of oval bamboo planks

Product code	PS.Plank.OV
Dimensions (L x W x H)	185 x 79 x 3 cm
Material	FSC bamboo
Weight	2 x 12 kg

head office address

HeBlad BV
Diamantweg 22
NL - 5527 LC Hapert

Related products

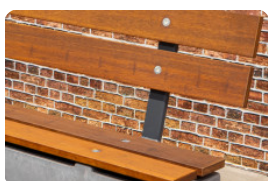

PS.Plank



BB.DL.OV



BB.DLA.OV



BB.STA.OV

Our products are delivered from our factory in the Netherlands.